

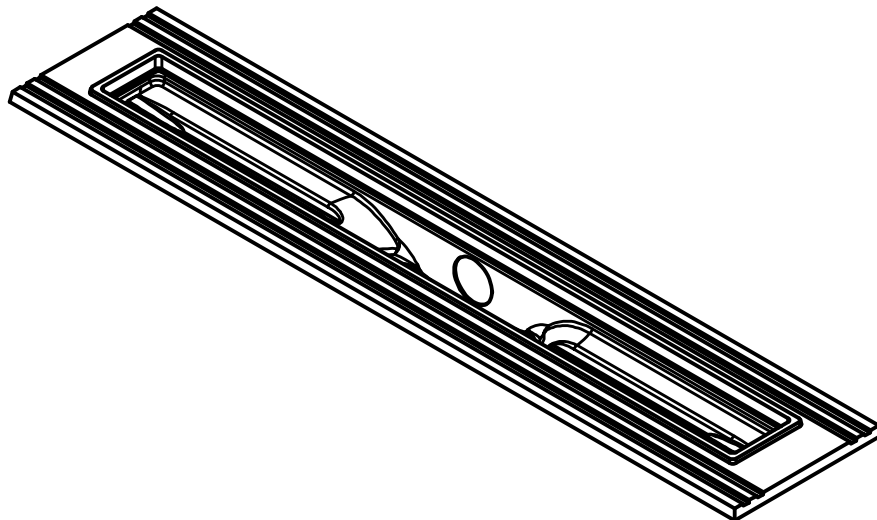

A-A (1/2)

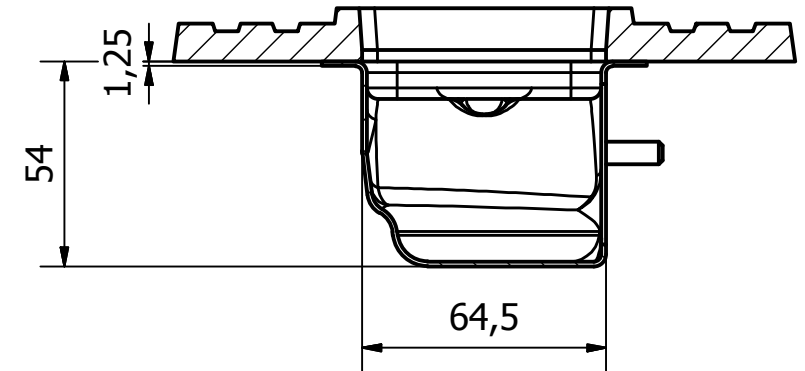

 I-DRAIN [®]		I-DRAIN NEDERLAND B.V. Teugseweg 20 7418 AM Deventer Postbus 131 7400 AC Deventer T +31 (0)570 74 54 00 E info@i-drain.nl www.i-drain.nl		
PROJECT:ED.SS.0900	Tol: ISO-2768-C	Datum: 1/06/2017	A4	
Omschrijving:ED.SS.0900	Tekenaar: Jonas	Materiaal:	Schaal: 1/8	
Goedkeuring:	Tekening:ED.SS.0900.dwg		Rev.1	