

Installation Guide and Users Manual

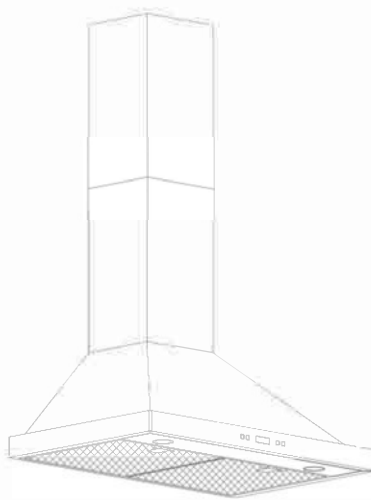

IMPORTANT:
Read and save these instructions.

NOTICE:
Installer: Leave this guide with the homeowner
Homeowner: Keep this guide for future reference

Wall Mount Range Hood

Important Safety Notice

Read all Instructions before Installing and operating this appliance

- The installation in this manual is intended for qualified installers, service technicians or persons with similar qualified background. Installation and electrical wiring must be done by qualified professionals and in accordance with all applicable codes and standards, including fire-rated construction.
- **DO NOT** attempt to install this appliance yourself. Injury could result from installing the unit due to lack of appropriate electrical and technical background.
- Range hood may have very sharp edges; please wear protective gloves if it is necessary to remove any parts for installing, cleaning or servicing.
- Activating any switch ON before completing installation may cause ignition or an explosion.
- Due to the size and weight of this range hood, two people installation is recommended.

To reduce the risk of fire, electric shock, or injury to persons:

- For general ventilating use only. **DO NOT** use to exhaust hazardous or explosive materials and vapors.
- The combustion air flow needed for safe operation of fuel-burning equipment may be affected by this unit's operation. Follow the heating equipment manufacturer's guideline and safety standards such as those published by the National Fire Protection Association (NFPA), and the American Society of Heating, Refrigeration and Air Conditioning Engineers (ASHRAE), and the local code authorities.
- Before servicing or cleaning unit, switch power OFF at service panel and lock service panel to prevent power from being switched ON accidentally.
- Clean grease laden surfaces frequently. To reduce the risk of fire and to disperse air properly, make sure to vent air outside. **DO NOT** vent exhaust into spaces between walls, crawl spaces, ceiling, attics or garages.
- Ducted fans **MUST** always be vented to the outdoors.
- Use only metal ductwork and this unit **MUST** be grounded.
- Sufficient air is needed for proper combustion and exhausting of gases through the duct to prevent back drafting.
- When cutting or drilling into wall or ceiling, be careful not to damage electrical wiring or other hidden utilities.
- All electrical wiring must be properly installed, insulated and grounded.
- Old duct work should be cleaned or replaced if necessary to avoid the possibility of a grease fire.
- Check all joints on duct work to insure proper connection and all joints should be properly taped.
- Use this unit only in the manner intended by the manufacturer. If you have questions, contact the vendor.

To reduce the risk of a stove top grease fire:

- Keep all fan, baffle, spaces, filter, grease tunnel, oil container and grease-laden surfaces clean. Grease should not be allowed to accumulate on fan, baffle, spaces, filter, grease tunnel and oil container.
- Always turn range hood ON when cooking at high heat or when cooking flaming foods.
- Use high settings on cooking range only when necessary.
- Never leave surface units unattended at high settings. Boil overs cause smoking and greasy spillovers that may ignite. Heat oils slowly on low or medium settings.

Important Safety Notice

Read all Instructions before Installing and operating this appliance

- Clean ventilating fan frequently.
- Always use appropriate cookware and utensils size.
- Always use cookware appropriate for the size of the surface element.

To reduce the risk of injury to persons in the event of a stove top grease fire:

- SMOOTHER FLAMES with a close-fitting lid, cookie sheet, or metal tray, then turn OFF the burner. BE CAREFUL TO PREVENT BURNS. NEVER PICK UP A FLAMING PAN—you may be burned. KEEP FLAMMABLE OR COMBUSTIBLE MATERIAL AWAY FROM FLAMES. If the flames DO NOT go out immediately, EVACUATE AND CALL THE FIRE DEPARTMENT or dial your local emergency service immediately.
- DO NOT USE WATER, including wet dishcloths or towels—a violent steam explosion will result.
- Use an extinguisher ONLY if:
 - You know you have a Class A, B, C extinguisher, and you already know how to operate it.
 - The fire is small and contained in the area where it is started.
 - The fire department is being called.
 - You can fight the fire with your back to an exit.

To reduce the risk of injury to persons in the event of a gas leak:

- Extinguish any open flame.
- DO NOT turn on the range hood fan or any type of ventilator.
- DO NOT turn on the lights or any type of appliance.
- Open all doors and windows to disperse the gas. If you still smell gas, call the gas company and fire department, or dial your local emergency service immediately.

Your safety and the safety of others is very important. We have provided many important safety messages in this manual and on your appliance. Always read and obey all safety messages. All safety messages will tell you what the potential hazard is, tell you how to reduce the chance of injury, and tell you what can happen if the instructions are not followed.



This is the safety alert symbol. This symbol alerts you to potential hazards that can hurt you and others. All safety messages will follow the safety alert symbol and the word “WARNING”.

The manufacturer and/or distributor/reseller declines all responsibility in the event of failure to observe the instructions given here for installation, maintenance and suitable use of the product. The manufacturer and/or distributor/reseller further declines all responsibility for injury due to negligence and the warranty of the unit automatically expires due to improper maintenance. The manufacturer and/or distributor/reseller will not be held responsible for any damages to personal property or real estate or any bodily injuries whether caused directly or indirectly by the range hood.

Table of Contents

INSTALLATION		USE AND CARE	
Tools needed.....	3	Range hood operations.....	12-15
Parts supplied.....	4	Troubleshooting.....	16
Venting requirements.....	5	Use and care information.....	17
Mount heights & clearance.....	5-6	Specifications.....	17
Calculating vent system length.....	6	MAINTENANCE	
Venting methods.....	7	Cleaning.....	18
Electrical requirements.....	8	Replacing the filter & light bulb.....	18
Preparation.....	9	WARRANTY	
Installation.....	10-11	Coverage & exceptions.....	19
Installation overview.....	11	Disclaimer & contact us.....	20

Tools needed:



Marker or pencil



Utility knife



Measuring tape

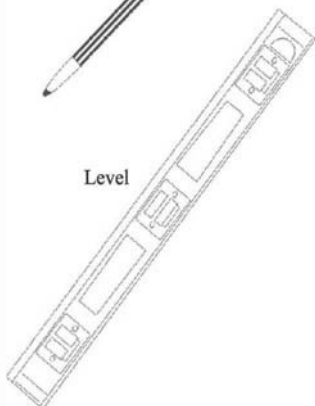

Level



Powered screwdriver or drill

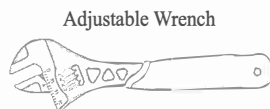

Adjustable Wrench

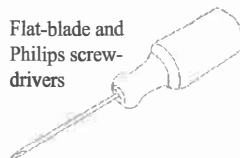

Flat-blade and Philips screwdrivers

Range hood



Lower Chimney



Upper Chimney

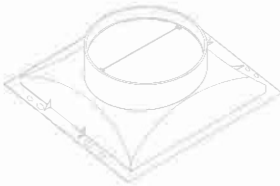

Ducting Transition



Optional Duct Tube

Screw Set



A1:Qty=4

A2:Qty=2



B1:Qty=4

B2:Qty=2



C:Qty=6



Aluminum filter

Venting Requirements

- Vent system must terminate to the outside (roof or side wall).
- DO NOT terminate the vent system in an attic or other enclosed area.
- DO NOT use 4" (10.2 cm) laundry-type wall caps.
- Use metal/aluminum vent only. Rigid metal/aluminum vent is recommended.
- DO NOT use plastic vent.
- Always keep the duct clean to ensure proper airflow.
- Calculate the following figures before installation:
 1. Distance from the floor to the ceiling.
 2. Distance between the floor to the countertop/stove (recommend* 28" to 31").
 3. Distance between the countertop/stove to the range hood.
 4. Height of hood and duct cover.

For the most efficient & quiet operation:

- A distance of 28" to 31" is recommended* between stove top and the bottom of range hood.
- It is recommended that the range hood be vented vertically through the roof through 8" (20.3 cm) or bigger round metal/aluminum vent work.
- The size of the vent should be uniform.
- Use no more than three 90° elbows.
- Make sure there is a minimum of 24" (61 cm) of straight vent between the elbows if more than one elbow is used.
- DO NOT install two elbows together.
- The length of vent system and number of elbows should be kept to a minimum to provide efficient performance.
- The vent system must have a damper. If roof or wall cap has a damper, DO NOT use damper (if supplied) on top of the range hood.
- Use silver tape or duct tape to seal all joints in the vent system.
- Use caulking to seal exterior wall or roof opening around the cap.

* Due to different ceiling height configurations, recommended height may not be applicable.

Height & Clearance

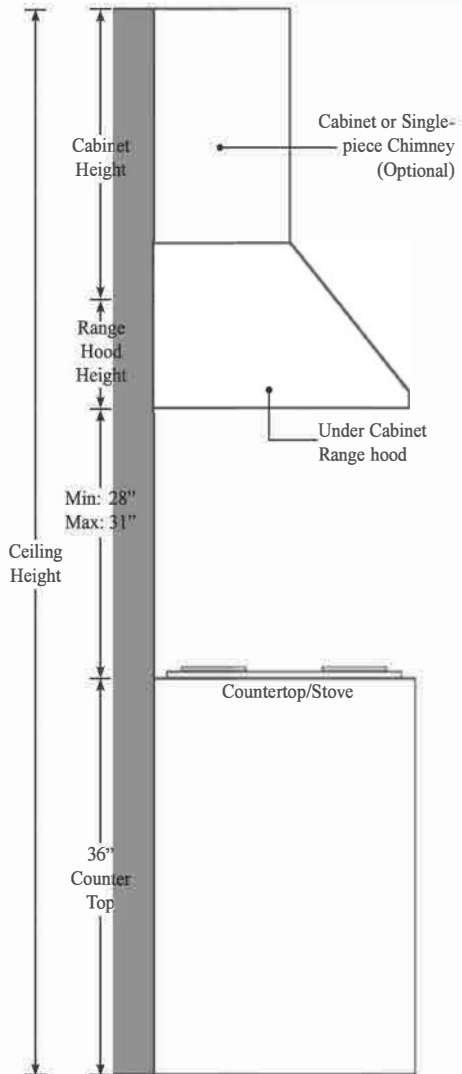

IMPORTANT:

- A minimum of 6” round (standard for this range hood) or 3-1/4 x 10” rectangular duct (purchased separately) must be used to maintain maximum airflow efficiency.
- Always use rigid type metal/aluminum ducts if available to maximize airflow when connecting to provided duct.
- Please use *Duct Run Calculation* below to compute total available duct run when using elbows, transitions and caps.
- ALWAYS, when possible, reduce the number of transitions and turns. If long duct run is required, increase duct size from 8” to 9” or 10”. If a reducer is used, install a long reducer instead of a pancake reducer. Reducing duct size will restrict airflow and decrease airflow, thus reduce duct size as far away from opening as possible.
- If turns or transitions are required: Install as far away from opening and as far apart, between 2, as possible.
- Minimum mount height between stove top to hood bottom should be no less than 28-inch*.
- Maximum mount height between stove top to hood bottom should be no higher than 31-inch*.
- It is important to install the hood at the proper mounting height. Hoods mounted too low could result in heat damage and fire hazard; while hoods mounted too high will be hard to reach and will lose its performance and efficiency.
- If available, also refer to stove top manufacturer’s height clearance requirements and recommended hood mounting height above range.
 - * Due to different ceiling height configurations, recommended height may not be applicable.

Minimum Duct Size:

- Round - 6” minimum
- Rectangular - 3-1/4 x 10” minimum (requires a 8” to 3-1/4x10” adaptor, not supplied)

Calculating Vent System Length

To calculate the length of the system you need, deduct the equivalent feet for each vent piece used in the system from the recommended maximum duct run.

Duct Run Calculation:	
Recommended maximum run	
8” or 3-1/4 x 10” duct	50 ft
Vent piece deduction	
Each 90° elbow used	9 ft
Each 45° elbow used	5 ft
Each 8” to 3/14 x 10” transition used	7 ft
Side wall cap with damper	0 ft
Roof cap	0 ft

Duct Run Calculation example:

One roof cap, two 90° elbow, and one 45° elbow used:

0ft + 9ft + 9ft + 5ft = 23ft used.

Deduct 23ft from 50ft, 27ft maximum available for straight duct run.

Venting Methods

- This range hood is factory set for venting through the roof or wall.
- Vent work can terminate either through the roof or wall. To vent through a wall, a 90° elbow is needed.

IMPORTANT:

- NEVER exhaust air or terminate duct work into spaces between walls, crawl spaces, ceiling, attics or garages. All exhaust must be ducted to the outside.
- Use metal/aluminum duct work only.
- Fasten all connections with sheet metal screws and tape all joints with certified Silver Tape or Duct Tape.
- Use caulking to seal exterior wall or roof opening around the cap.

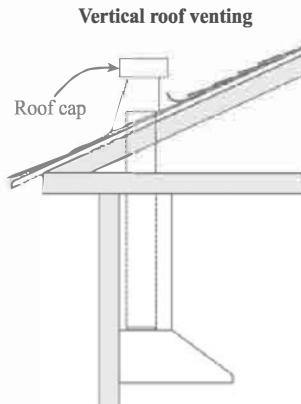
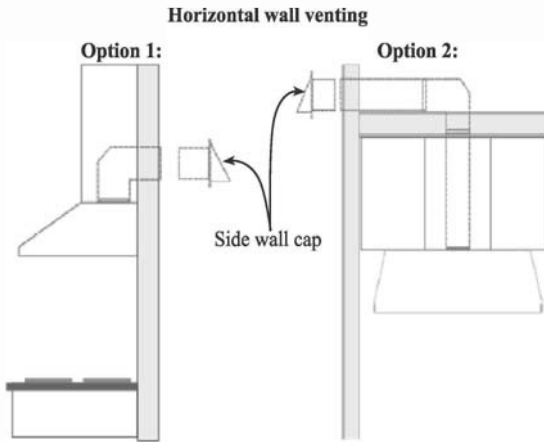

Electrical Requirements

IMPORTANT: For Europe and Other Countries with 220~240V/50Hz, please observe your local governing codes and ordinances.

It is the customer's responsibility:

- To contact a qualified electrical installer.
- To assure that the electrical installation is adequate and in conformance with National Electrical Code, ANSI/NFPA 70 — latest edition*, or CSA Standards C22. 1-94, Canadian Electrical Code, Part 1 and C22. 2 No. 0-M91 - latest edition** and all local codes and ordinances.

If codes permit and a separate ground wire is used, it is recommended that a qualified electrician determine that the ground path is adequate.

A 110~120V/60Hz, AC-only, fused electrical supply is required on a separate 15-amp circuit, fused on both sides of the line.

Do not ground to a gas pipe.

Check with a qualified electrician if you are not sure that the range hood is properly grounded.

Do not have a fuse in the neutral or ground circuit.

IMPORTANT: Save Installation Instructions for electrical inspector's use.

The range hood must be connected with copper wire/plug only.

The range hood should be connected directly to the fused disconnect (or circuit breaker) box through flexible armored or non-metallic sheathed copper cable. A U.L. - or C.S.A. - listed strain relief must be provided at each end of the power supply cable.

Wire sizes (COPPER WIRE ONLY) and connections must conform with the rating of the appliance as specified on the model/serial rating label. Wire sizes must conform to the requirements of the National Electrical Code ANSI/NFPA 70 — latest edition*, or CSA Standards C22. 1-94, Canadian Electrical Code Part 1 and C22. 2 No. 0-M91 - latest edition** and all local codes and ordinances. A U.L. - or C.S.A. - listed conduit connector must be provided at each end of the power supply cable (at the range hood and at the junction box).

Copies of the standards listed may be obtained from:

* National Fire Protection Association
Batterymarch Park
Quincy, Massachusetts 02269

** CSA International
8501 East Pleasant Valley Road
Cleveland, Ohio 44131-5575

Preparation

Advanced Preparations:

1. Be familiar with the controls of the range hood by reading through *Range Hood Operations*, Page 12.
2. Place the range hood on a flat, stable surface. Connect the range hood to a designated standard outlet, 110~120V/60Hz (220~240V/50Hz for Europe & other countries), AC only and turn on the range hood. Verify all operations of the range hood by referring to *Range Hood Operations*, Page 12.
3. Place all supplied parts and required hardware on a flat, stable surface and verify the existence of all supplied parts listed on Page 4.
4. Carefully remove the white plastic protective coat from the chimney covers and range hood.

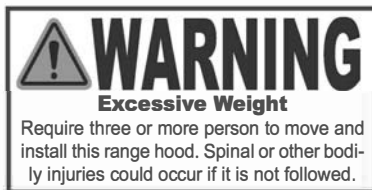

Preparations:

1. Determine and mark the center line on the ceiling where the range hood will be installed. Make sure there is proper clearance within the ceiling or wall for exhaust vent.
2. Due to the weight and size of this unit, please make sure that the support system or framework being used is stable and secure in the wall.
3. Put a thick, protective covering over counter top, cook top or range to protect from damage or dirt. Remove any hazardous objects around the area when installing.
4. Mark the locations of the support mounting bracket holes, vent cutout (if used) and power supply cable cutout on the ceiling. Use drill and saber saw or keyhole saw to cut openings for power supply cable and vent (see *Venting requirements* and *Electrical requirements*, Pages 5-8).
5. If venting to the outside install vent system (see *Venting Requirements*, Page 5). Use caulking to seal exterior wall or roof openings.
6. Disconnect main electrical supply, prepare and run electrical wiring through ceiling or wall. Leave approximately 12" of electrical cord hanging from the ceiling. Do not restore power until wiring is completed.
7. Set aside the Aluminum filters and grease cup until the range hood is properly installed
8. *If the range hood comes with a glass canopy and has not already been mounted to the hood, loosen the four canopy screws and washers from the hood top, carefully place the canopy on the hood top, and loosely tighten the four canopy screws along with washers. DO NOT put excessive pressure against the glass.*



Installation

Installations (refer to page 4 & 11 for parts):

1. Measure the distance between stove top and the bottom of range hood. A distance of 28" to 31" is required.
2. Make sure the range hood is level and not tilted. Mark the locations of the hanging bracket holes on the wall as shown in Figure 3A and Figure 3B.
3. Place the mounting bracket **directly** above the range hood, level it, and mark the locations of the mounting bracket holes on the wall.
4. Place aside all equipments, locate marked regions and drill holes. Attach range hood to wall using anchors recommended for your type of wall:
 - Sheet rock wall: Attach range hood to stud blockings if possible. If stud blockings are not available, it is required to build a supporting structure behind the sheet rock for best weight support.
 - Concrete wall: Use designated screws (not provided).
 - Wood wall: Use at least 5 cm long wood screws (not provided).
6. Fasten two Type "A" anchors (for range hood and for mounting bracket or air diverter) on the wall as shown in Figure 4. Loosely fasten two Type "B" screws onto anchors, DO NOT fasten screws all the way. Hang the range hood on the Type "B" screws and hand tighten them. Leave approximately 1/8" of gap from the wall to the range hood.
7. Place the mounting bracket against the wall and align the holes from mounting bracket with holes from Type "A" anchors, fasten two Type "B" screws through the holes onto the anchors as shown in Figure 5. Leave approximately 1/8" of gap from the wall to the mounting bracket.

Figure 3A

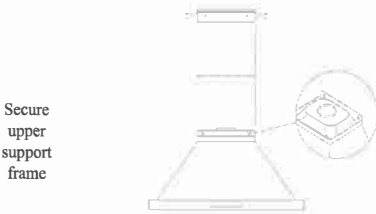

Figure 4

Fasten mounting bracket

Slide up and secure upper chimney to mounting bracket

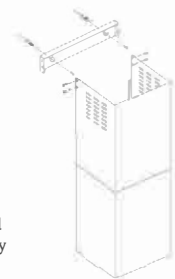
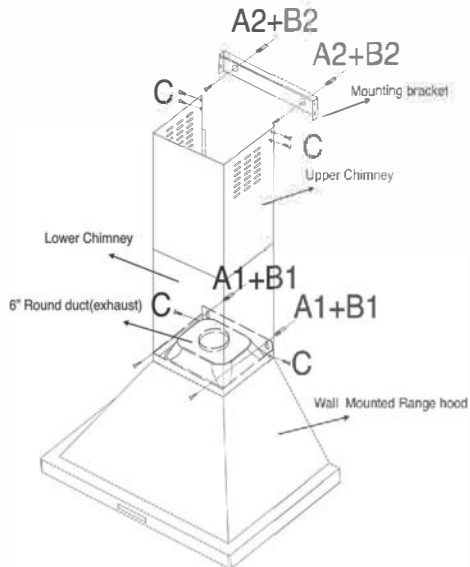

Figure 3B

Figure 5

Installation (Continued)

- Calculate the height of the duct tube and extend approximately 6" (15 cm) longer than required, connect the lower end of the duct tube to the range hood and the upper end to the vent system. Make sure the main electrical supply remains disconnected then connect power plug to the electrical cord or wall plug.
- Have one person carefully position both upper and lower chimneys on the range hood, let the second person slide the sides of the chimneys into the 1/8" gap. Fasten both chimneys with four Type "C" screws.
- Install grease cup and aluminum filters then check the operation of the range hood.



Range Hood Operations & Wiring Diagram

Control Panel Layout and Buttons Configurations:

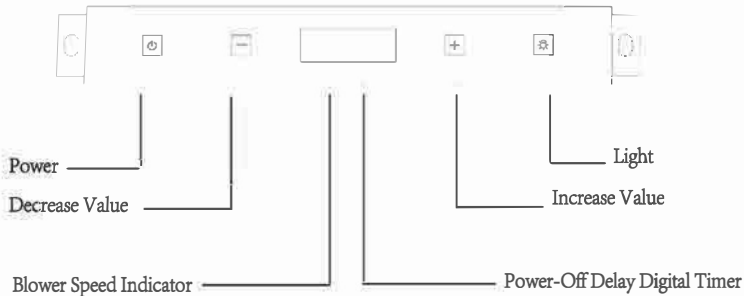

The Canopy hood is designed to remove smoke, cooking vapors and odors from the cook top area. For best results, start the range hood before cooking and allow it to operate several minutes after the cooking complete to clear all smoke and odors from the kitchen.

• Button functions:

- Power: Power ON/OFF and activate power-off delay timer.
- Decrease Value: Blower (motor) speed decrease, Time setting decrease..
- Increase Value: Blower (motor) speed increase, Time setting increase.
- Blower Speed Indicator: Shows current blower (motor) speed (1-4)..
- Light: Turns ON/OFF
- Power-Off Delay Digital Timer: Indicates the length of time left for delay off function.

• Controls:

• Adjusting the blower (motor) speed:

- Press Power button once to turn on the system. Decrease Value button will decrease the speed of the blower (motor) from 4 to 1 (strongest to quietest). Increase Value button will increase the speed of the blower (motor) from 1 to 4 (quietest to strongest)
- Press Power button once to turn on the system., and Press it twice to turn off it.

Note: The system saves user configurations, hence settings such as light, timer and blower (motor) speed will remain the same the next time it is turned on.

Range Hood Operations & Wiring Diagram (Continued)

Control Panel Layout and Buttons Configurations:

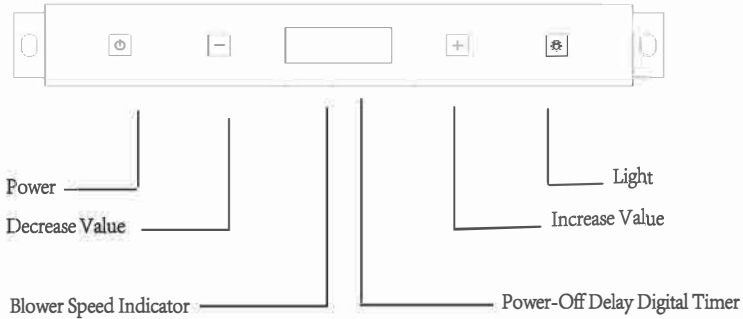

- Controls:

- Activating the timer function:

- While the blower(motor) is running, press Power button once to enter Power-Off Delay Timer, The working time is 15 minutes which is changeless and the range hood will turn off automatically then.

Note: Light settings are independent from other settings (including power-off delay) and lights has to be manually turned on or off.

Note: The system saves user configurations, hence settings such as light, timer and blower (motor) speed will remain the same the next time it is turned on.

Range Hood Operations & Wiring Diagram (Continued)

Control type - Touch Sensitive Version (Four speed with type GU10 bulb)

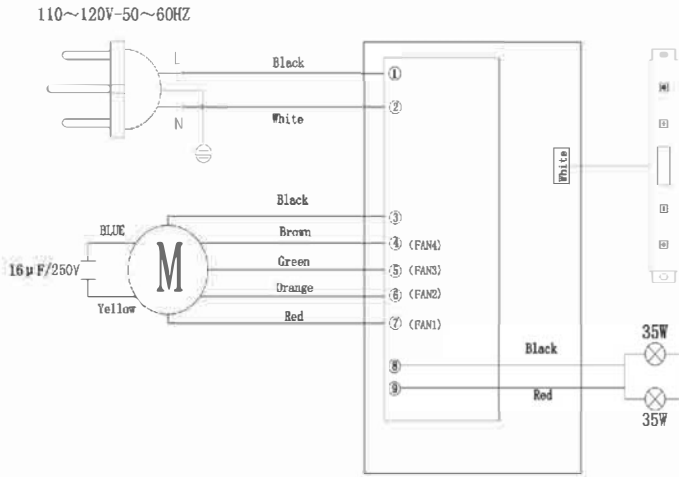

Range Hood Measurements

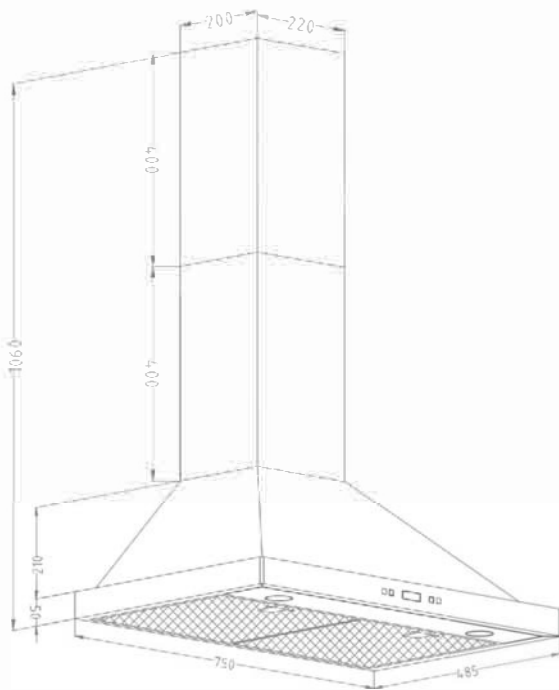

Troubleshooting

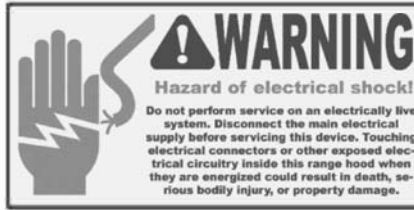

1. If the range hood does not operate after installation:
 - Check if the range hood has been plugged in, make sure that all power has been turned back on and all electrical wiring are properly connected.
 - Swap out light assembly to working ones to determine whether it is caused by defective bulbs. (See *Replacing the light bulbs*, page 16)
2. The range hood vibrates when the blower is on:
 - The range hood might not have been secured properly on to the ceiling.
3. The blowers seems weak:
 - Check that the duct sized used is at least 8" (20 cm). Range hood WILL NOT function efficiently with insufficient duct size. For example: 10" (25.4 cm) duct over 8" (20 cm) hole and loosely secured.
 - Check if duct is clogged or if damper unit is not opening properly. A tight mesh on a side wall cap unit might also cause restriction to the air flow.
4. The lights work but the blower is not spinning at all, is stuck or is rattling.
 - The blower might be jammed or scraping the bottom due to shipping damage.
5. The hood is not venting out properly:
 - Make sure the distance between the cook top and the bottom of the hood is within 28" (71 cm) and 33" (79 cm) in range.
 - Reduce the number of elbows and length of duct work. Check if all joints are properly connected, sealed, and taped.
 - Make sure the power is on high speed for heavy cooking

NOTE: For all other inquiries, please contact your local reseller.

Use and Care Information

WARNING — TO REDUCE THE RISK OF FIRE, ELECTRIC SHOCK, OR INJURY TO PERSONS, OBSERVE THE FOLLOWING: Use this unit only in the manner intended by the manufacturer. If you have questions, contact the manufacturer. Before servicing or cleaning unit, switch power off at service panel and lock switch power off at service panel and lock service panel to prevent power from being switched on accidentally. When the service disconnecting means cannot be blocked, securely fasten prominent warning device such as a tag to the service panel.

CAUTION: For general ventilating use only. Do not use to exhaust hazardous or explosive materials and vapors.

WARNING — TO REDUCE THE RISK OF A RANGE TOP GREASE FIRE: Never leave surface units unattended at high settings. Boil overs cause smoking and greasy spill-overs that may ignite. Heat oils slowly on low or medium settings.

Always turn hood ON when cooking at high heat or when cooking flaming foods.

Clean ventilating fans frequently. Grease should not be al-

lowed to accumulate on fan or filter.

Use proper pan size. Always use cookware appropriate for the size of the surface element.

WARNING — TO REDUCE THE RISK OF INJURY TO PERSONS IN THE EVENT OF A RANGE TOP GREASE FIRE, OBSERVE THE FOLLOWING: SMOTHER FLAMES with a close-fitting lid, cookie sheet, or metal tray, then turn off the burner. BE CAREFUL TO PREVENT BURNS. If the flames do not go out immediately, EVACUATE AND CALL THE FIRE DEPARTMENT. NEVER PICK UP A FLAMING PAN— you may be burned. DO NOT USE WATER, including wet dishcloths or towels — a violent steam explosion will result. Use an extinguisher ONLY if:

You know you have a Class ABC extinguisher, and you already know how to operate it.

The fire is small and contained in the area where it is started.

The fire department is being called. You can fight the fire with your back to an exit.

Specifications

Specifications*:	
Body	Stainless Steel
Power Rating	110~120V/60Hz or 220~240V/50Hz (USA and Canada Standard)
General Input Power	268 W (198W + 2x35W)
Motor Input Power	198 W (Singel Motor)
Motor Revolution	420 RPM (±10%) to 900 RPM (±10%)
Levels Of Speed Control	4 Levels
Maximum Airflow	600(±10%) cfm
Air Pressure	280 pa
Noise Level (dB / sone)	Approximately 28 / 0.7 to 53 / 5.6 (Lowest to highest Speed)
Motor Type	Singel Chamber Ultra Quiet
Fan Type	Dual Centrifugal / Sirocco
Control Type	4 Speed Electronic Control Panels
Illumination	35W
Venting Size	6 inch (15 cm) Round
Interference Protection	Radio Frequency Interference Protected

1. In House Test Static Pressure "0".

2. One sone is roughly equivalent to the sound of a refrigerator (1kHz) at 40 decibels.

3. Subject to change without notice, please contact your local reseller for details.

Maintenance

SAFETY WARNING: Never put your hand into area housing the fan while the fan is operating!

For optimal operation, clean range hood and all baffle/spacer/filter/grease tunnel/oil container regularly. Regular care will help preserve the appearance of the range hood.

Cleaning Exterior surfaces:

- Clean periodically with hot soapy water and clean cotton cloth. Do not use corrosive or abrasive detergent (e.g. Comet Power Scrub®, EZ-Off® oven cleaner), or steel wool/scoring pads, which will scratch and damage the stainless steel surface. For heavier soil use liquid degrease such as “Formula 409®” or “Fantastic®” brand cleaner.
- If hood looks splotchy (stainless steel hood), use a stainless steel cleaner to clean the surface of the hood. Avoid getting cleaning solution onto or into the control panel. Follow directions of the stainless steel cleaner. **CAUTION: Do not leave on too long as this may cause damage to hood finish.** Use soft towel to wipe off the cleaning solution, gently rub off any stubborn spots. Use dry soft towel to dry the hood.
- After cleaning, you may use non abrasive stainless steel polish such as 3M® or ZEP®, to polish and buff out the stainless luster and grain. Always scrub lightly, with clean cotton cloth, and with the grain.
- **DO NOT** allow deposits to accumulate or remain on the hood.
- **DO NOT** use ordinary steel wool or steel brushes. Small bits of steel may adhere to the surface and cause rusting.
- **DO NOT** allow salt solutions, disinfectants, bleaches, or cleaning compounds to remain in contact with stainless steel for extended periods. Many of these compounds contain chemicals, which may be harmful. Rinse with water after exposure and wipe dry with a clean cloth.

Cleaning Metal Filters:

IMPORTANT: Drain oil from oil containers before oil and residue overflow!

- The metal filters fitted by the factory are intended to filter out residue and grease from cooking. It need not be replaced on a regular basis but are required to be kept clean.
- Filters should be cleaned after every 30 days of use.
- Remove and clean by hand or dishwasher. Spray “Formula 409®” or equivalent degreasing detergent and leave to soak if heavily soiled. Dry filters and re-install before using hood.

Replacing Filters:

- The metal filters are designed to last but are required to be replaced if damaged, please contact your local reseller for replacement filters.

Replacing the light bulb:

- This range hood uses halogen bulb (please refer to the actual specification of the hood purchased):

USA/Canada:

35W Type MR16 12V / Type GU10 120V

Europe and other Countries:

35W Type MR16 12V / Type GU10 220V

- Make sure the range hood is unplugged or turn OFF breaker.
- Make sure the lights are cool to touch, carefully align the arrow on the inner ring with the arrow on the outer ring where it says OPEN. The inner ring will loosen and the light bulb will be available for removal. Install a new halogen light bulb and reverse the steps.
- Turn ON breaker and range hood to test for operation.

Align arrows on both rings



WARNING

Hazard of Burns!

Light bulb become extremely hot when turned on.
DO NOT touch bulb until switched off and cooled.
Touching hot bulbs could cause serious burns.

Warranty

TO OBTAIN SERVICE UNDER WARRANTY:

You must present proof of original purchase date.

Please provide an original dated proof of purchase (sales receipt / invoice) in order to obtain service under warranty.

One Year Parts Warranty:

For one year from the date of original purchase, your local reseller will provide free of charge, non-consumable replacement parts or components that failed due to manufacturing defects. Subject to the conditions and limitations set forth below, your local reseller will, at its option, either repair or replace any part of its products that prove defective by reason of improper workmanship or materials. Repaired parts or replacement products will be provided by your local reseller on an exchange basis, and will be either new or refurbished to be functionally equivalent to new. The consumer is responsible for all shipping costs. Consumable parts not covered by this warranty include but not limited to: Light bulbs, metal, aluminum and charcoal filters.

Who is Covered:

This warranty is extended to the original purchaser for products purchased for ordinary home use.

This Warranty Will Be Voided When:

Product damaged through negligence, improper installation, accident, abuse, misuse, natural disaster, insufficient or excessive electrical supply, abnormal mechanical or environmental conditions, or any unauthorized disassembly, repair, modification, or failure to follow installation instructions. When product is used commercially or other than its intended purpose. Damaged because of improper connection with equipment of other manufacturers. Repaired or modified by anyone other than your local reseller's authorized agents. This limited warranty also does not apply to any product on which the original identification information has been altered, obliterated or removed, has not been handled or packaged correctly or has been sold as second-hand.

What is Not Covered:

Consumable parts such as light bulbs, metal and charcoal filters. The natural wear of finish, and wear due to improper maintenance, use of corrosive and abrasive cleaning products, pads, and oven cleaner products. Chips, dents or cracks due to abuse, misuse, freight damage, or improper installation. Damage of product caused by accident, fire, floods or act of God. The manufacturer and/or distributor/reseller is not liable for, and does not cover under warranty, any loss of properties or any costs associated with removing, servicing, installing, or determining the source of problems with this product.

This warranty is valid in the country of the original purchase at retail. It is non-transferable and applies only to the original purchaser and does not extend to subsequent owners of this product. Any applicable implied warranties, including the warranty of merchantability, are limited in duration to a period of express warranty as provided herein beginning with the date of original purchase at retail and, no warranties, whether express or implied, shall apply to this product thereafter.

To obtain warranty service, you may contact your local reseller from which you purchased this product. Please confirm the terms of your local reseller's policies prior to contacting. Typically, you must include product identification information, including model number and serial number with a detailed description of the problem you are experiencing. You must also include proof of the date of original retail purchase as evidence that the product is within the applicable warranty period.

Disclaimer

Carefully inspect all items for damages before accepting delivery. Note any damages on the freight bill or express receipt. Request name and signature of the carrier's agent and keep copy to support your claim. Upon acceptance of items, owner assumes responsibility for its safe arrival. Report damages to the carrier and file a claim immediately. Failure to do so may result in the denial of your claim. The carrier will furnish you with necessary forms for filing a claim.

Damages caused during transit are not covered under our warranty. Please contact us to file an insurance claim.

Please inspect contents of package(s) carefully upon receiving! We must be notified of any damages and/or missing parts within five (5) days upon your receipt of package(s). Claims will not be accepted after five (5) days. NOTE: Items were thoroughly tested and carefully packed in our factory before shipping.

Products must be returned in good working condition with ALL original parts and documentation packed in ALL original cartons, fillers and shipping cartons. A restocking fee of 15% will be charged for all approved return(s). Exchanges or returns may not be accepted if any packaging is missing.

Make sure to inspect the hood for damages and defects before installation. Appearance flaws of the hood found after installation and not affecting hood performance is not covered under our warranty for returns or exchanges. Service visits not covered under warranty will carry a service charge.

Before Installation: Return for exchange or refund (please see above for acceptable returns).

After Installation: **NO** exchange or refund.

If you need replacement parts, we recommend that you only use genuine parts. Our accessories and parts are engineered and designed specifically for this series of range hood, each is rigorously tested assuring the utmost in durability and reliability, providing a factory match, factory-installed appearance and functionality tailored to each individual range hood model.

Your Notes

Your Notes

