

GLOBAL Trac Lighting Systems

Quality in Focus





GLOBAL Trac is the most flexible way of creating elegant and appropriate lighting

Nordic Aluminium is the global market leader in lighting track systems. The success is based on the reliability, durability and high quality of the products. Nordic Aluminium is also a world class supplier. A reliable partner means stability and ensures that the products continue to be available in years to come.



One-stop service

Nordic Aluminium is a comprehensive lighting systems provider, which means you can find everything you need from one place. There are three systems to choose from: GLOBAL Trac Pulse is for new adaptable control applications, GLOBAL Trac Pro is the professional's choice for three-phase systems and GLOBAL Trac Base is a compact one-circuit basic track. All you need to do is to choose the system that best meets your needs. In addition, Nordic Aluminium supplies a wide range of UL approved track systems.



Our R&D looks to the future

The focus of the Nordic Aluminium's R&D is on the needs of the customer. We use patented solutions and continue to develop new products. All products are designed by the company's R&D department, which ensures high quality throughout the product range. The R&D department also follows technical trends in the lighting business.



Quick and easy installation

Diverse installation options are part of the package. All installation options are quick and easy to implement. The latest trend includes snap-on brackets for the tracks. The connectors and other accessories are reliable, and the customer can trust that the installation goes nice and smoothly.



GLOBAL Trac product range

GLOBAL Trac Pro

- The most popular three-phase track in the world
- Circuits can be controlled individually, easy to mount
- Modular solution, easy to extend/adapt
- Suitable for department stores and shops, recessed mounting version also available

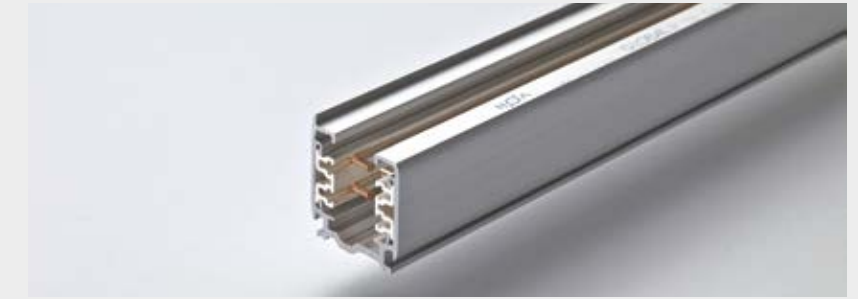

GLOBAL Trac Pulse

- A three-phase track for control systems
- Suitable for controlling diverse, adaptable lighting
- Can be used with all control systems, such as DALI, EIB, LON and 1-10V
- Suitable for areas that are challenging to illuminate and that require modern's control systems
- Fully FELV tested and approved



GLOBAL Trac Base

- A compact one-circuit track
- Small, elegant, compact
- Connectors can be fixed fast, "snap on" technic in covers
- Suitable for small business and exhibition structures, recessed mounting version also available



GLOBAL Trac suspension parts

- Diverse suspension options for each track system, respectively
- GLOBAL Trac Pro and GLOBAL Trac Pulse
- GLOBAL Trac Base
- Suspension examples



GLOBAL Trac adapters

- Three-circuit universal MULTI Adapters™
- Three-circuit adapters for the GLOBAL Trac Pulse system
- Three-circuit adapters for the GLOBAL Trac Pro system
- One-circuit adapters for the GLOBAL Trac Base system





GLOBAL Trac Pro

GLOBAL Trac Pro is the most sold three-circuit lighting track system in the world. It is the quality choice of professionals and lighting manufacturers. Long experience and 100% quality assurance ensure problem-free operation. Diverse installation options are part of the package. All options are quick and easy to implement and result in overall cost savings.



For various spaces

GLOBAL Trac Pro's high load capacity and circuit-specific control option can be used in many different spaces, including shops, department stores, public buildings, restaurants, airports and offices.



Also for suspended ceilings

There is a recessed version of GLOBAL Trac Pro for suspended ceilings, too. The standard colours are grey, white and black, as in all GLOBAL Trac Pro tracks.



Easy to extend

The modular structure of the system makes it easy to extend and adapt to various needs. Modular dimensions help designers fit the system into the appropriate space and also make on-site mounting easier. Reliable connectors ensure fast and easy installation.



GLOBAL Trac Pro

L1/L2/L3/neutral/ground 16 A/400 V. IP20.

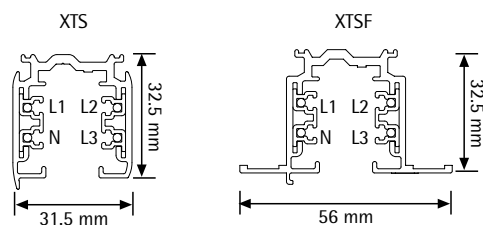
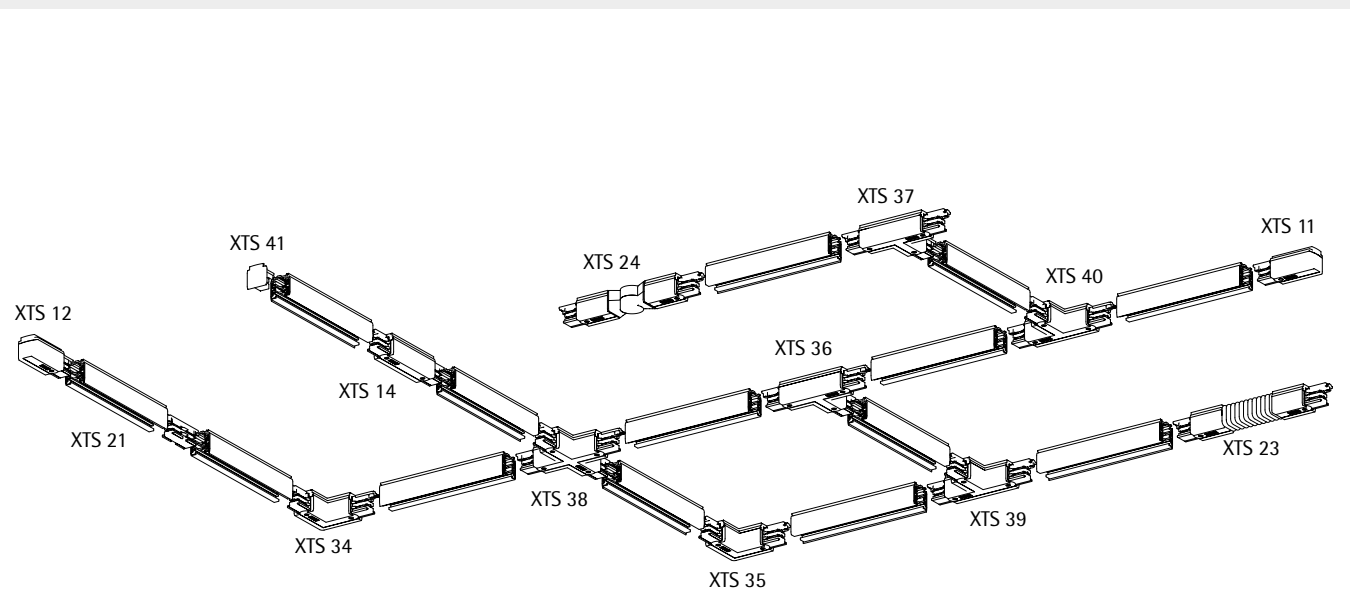

The recommended fastening distance is 1000 mm.
NOTE: A load not heavier than 10 kg may hang on a power takeoff adapter, the pull strength being 100 N (1kp = 9.81N) and the maximum torque 2.5 Nm. (GA 69 5 kg/50 N).

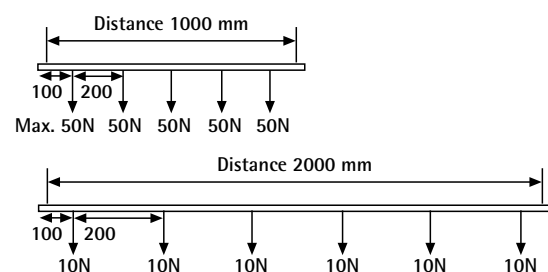

L/mm	a/mm	b/mm	c/mm	d/mm
1000	250			
2000	250	1000		
3000	250		1000	1000
4000	250		1500	1000

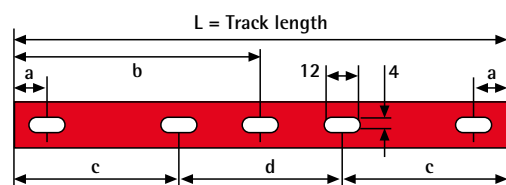

GLOBAL Trac Pro tracks

Available colours: - 1 grey (AW 202JR), -2 black (RAL 9005), -3 white (RAL 9010).

XTS 4100-4400

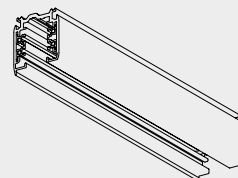

Type	EAN code	Dimensions in mm/ track length	Surface treatment/colour/ material	PCS/ Package
XTS 4100-1	64100 14 507 01-5	1000	Grey	4/240
XTS 4100-2	64100 14 506 01-8	1000	Black	4/240
XTS 4100-3	64100 14 507 06-0	1000	White	4/240
XTS 4200-1	64100 14 507 02-2	2000	Grey	4/240
XTS 4200-2	64100 14 506 02-5	2000	Black	4/240
XTS 4200-3	64100 14 507 07-7	2000	White	4/240
XTS 4300-1	64100 14 507 03-9	3000	Grey	4/240
XTS 4300-2	64100 14 506 03-2	3000	Black	4/240
XTS 4300-3	64100 14 507 08-4	3000	White	4/240
XTS 4400-1	64100 14 507 04-6	4000	Grey	4/240
XTS 4400-2	64100 14 506 04-9	4000	Black	4/240
XTS 4400-3	64100 14 507 09-1	4000	White	4/240

XTSF 4100-4400

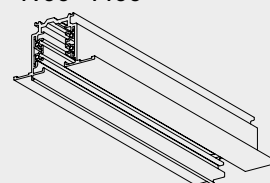

XTSF 4100-1	64100 14 507 51-0	1000	Grey	6/180
XTSF 4100-2	64100 14 506 51-3	1000	Black	6/180
XTSF 4100-3	64100 14 507 56-5	1000	White	6/180
XTSF 4200-1	64100 14 507 52-7	2000	Grey	6/180
XTSF 4200-2	64100 14 506 52-0	2000	Black	6/180
XTSF 4200-3	64100 14 507 57-2	2000	White	6/180
XTSF 4300-1	64100 14 507 53-4	3000	Grey	6/180
XTSF 4300-2	64100 14 506 53-7	3000	Black	6/180
XTSF 4300-3	64100 14 507 58-9	3000	White	6/180
XTSF 4400-1	64100 14 507 54-1	4000	Grey	6/180
XTSF 4400-2	64100 14 506 54-4	4000	Black	6/180
XTSF 4400-3	64100 14 507 59-6	4000	White	6/180

GLOBAL Trac Pro accessories

Power supply option in all connectors except XTS 21, XTS 23 and XTS 24. All materials used are halogen free and VO-self-extinguishing. Available colours: -1 grey (RAL 7040), -2 black (RAL 9005), -3 white (RAL 9010).

End feed XTS 11

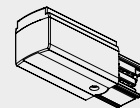

Type	EAN code	Polarity ridge	Surface treatment/colour/ material	PCS/ Package
XTS 11-1	64100 14 507 15-2		Grey	10/100
XTS 11-2	64100 14 506 11-7		Black	10/100
XTS 11-3	64100 14 507 11-4		White	10/100



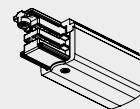



XTS 12

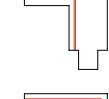
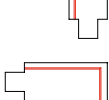
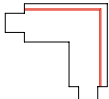
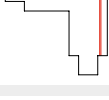
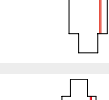
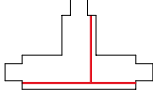
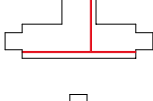
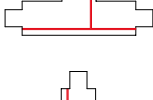
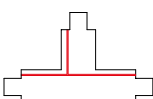

XTS 12-1	64100 14 507 16-9		Grey	10/100
XTS 12-2	64100 14 506 12-4		Black	10/100
XTS 12-3	64100 14 507 12-1		White	10/100

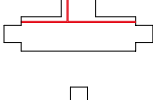
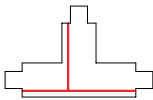
GLOBAL Trac Pro accessories

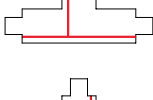
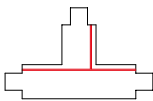
Power supply option in all connectors except XTS 21, XTS 23 and XTS 24.
Available colours: -1 grey (RAL 7040), -2 black (RAL 9005), -3 white (RAL 9010).

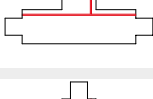
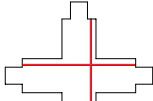
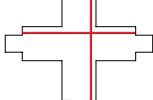
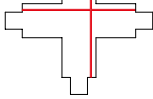
	Type	EAN code	Polarity ridge	Surface treatment/colour/material	PCS/Package
Middle feed XTS 14	XTS 14-1	64100 14 507 17-6		Grey	5/50
	XTS 14-2	64100 14 506 14-8		Black	5/50
	XTS 14-3	64100 14 507 14-5		White	5/50
Straight connector XTS 21	XTS 21-1	64100 14 507 18-3		Grey	10/100
	XTS 21-2	64100 14 506 21-6		Black	10/100
	XTS 21-3	64100 14 507 21-3		White	10/100
Flexible corner connector XTS 23	XTS 23-1	64100 14 507 20-6		Grey	5/25
	XTS 23-2	64100 14 506 23-0		Black	5/25
	XTS 23-3	64100 14 507 23-7		White	5/25
Adjustable corner connector XTS 24	XTS 24-1	64100 14 507 19-0		Grey	5/25
	XTS 24-2	64100 14 506 24-7		Black	5/25
	XTS 24-3	64100 14 507 24-4		White	5/25
L-feed XTS 34, 35	XTS 34-1	64100 14 507 25-1		Grey	5/25
	XTS 34-2	64100 14 506 34-6		Black	5/25
	XTS 34-3	64100 14 507 34-3		White	5/25
	XTS 35-1	64100 14 507 26-8		Grey	5/25
	XTS 35-2	64100 14 506 35-3		Black	5/25
	XTS 35-3	64100 14 507 35-0		White	5/25
T-feed XTS 36, 37, 39, 40	XTS 36-1	64100 14 507 27-5		Grey	5/25
	XTS 36-2	64100 14 506 36-0		Black	5/25
	XTS 36-3	64100 14 507 36-7		White	5/25
	XTS 37-1	64100 14 507 28-2		Grey	5/25
	XTS 37-2	64100 14 506 37-7		Black	5/25
	XTS 37-3	64100 14 507 37-4		White	5/25
	XTS 39-1	64100 14 507 30-5		Grey	5/25
	XTS 39-2	64100 14 506 39-1		Black	5/25
	XTS 39-3	64100 14 507 39-8		White	5/25
	XTS 40-1	64100 14 507 31-2		Grey	5/25
	XTS 40-2	64100 14 506 40-7		Black	5/25
	XTS 40-3	64100 14 507 40-4		White	5/25
X-feed XTS 38	XTS 38-1	64100 14 507 29-9		Grey	5/25
	XTS 38-2	64100 14 506 38-4		Black	5/25
	XTS 38-3	64100 14 507 38-1		White	5/25
End cap XTS 41	XTS 41-1	64100 14 507 32-9		Grey	10/100
	XTS 41-2	64100 14 506 41-4		Black	10/100
	XTS 41-3	64100 14 507 41-1		White	10/100

GLOBAL Trac Pro other parts

Available colours: -1 grey (RAL 7040), -2 black (RAL 9005), -3 white (RAL 9010).

Type	EAN code	Surface treatment/colour/material	PCS/Package
Hook base XTAK 142, 144, 146	XTAK 142-1	64100 14 507 43-5 For 2 mm wire/hook	50/250
	XTAK 142-2	64100 14 506 42-1 For 2 mm wire/hook	50/250
	XTAK 142-3	64100 14 507 42-8 For 2 mm wire/hook	50/250
	XTAK 144-1	64100 14 507 45-9 For M4 nut/rod	50/250
	XTAK 144-2	64100 14 506 44-5 For M4 nut/rod	50/250
	XTAK 144-3	64100 14 507 44-2 For M4 nut/rod	50/250
	XTAK 146-1	64100 14 507 47-3 For M6 nut/rod	50/250
	XTAK 146-2	64100 14 506 46-9 For M6 nut/rod	50/250
	XTAK 146-3	64100 14 507 46-6 For M6 nut/rod	50/250
Hook XTAK 11	XTAK 11-1	64100 14 500 79-5 Hook 2 mm	Steel 100/5000
Tool XTSV 12	XTSV 12	64100 14 500 99-3 Bending tool for power wires	Blue 1/100
Cover plates XTSF 10	XTSF 10-1	64100 14 500 41-2 Cover plate for XTS11-14	Grey 1/100
	XTSF 10-2	64100 14 506 61-2 Cover plate for XTS11-14	Black 1/100
	XTSF 10-3	64100 14 507 61-9 Cover plate for XTS11-14	White 1/100
XTSF 30	XTSF 30-1	64100 14 506 42-9 Cover plate for XTS34-40	Grey 1/100
	XTSF 30-2	64100 14 506 62-9 Cover plate for XTS34-40	Black 1/100
	XTSF 30-3	64100 14 507 62-6 Cover plate for XTS34-40	White 1/100
XTSF 40	XTSF 40-1	64100 14 506 43-6 Outlet/cover plate for feeds	Grey 1/100
	XTSF 40-2	64100 14 506 63-6 Outlet/cover plate for feeds	Black 1/100
	XTSF 40-3	64100 14 507 63-3 Outlet/cover plate for feeds	White 1/100
Cover strip XTSP 11	XTSP 11-2	64100 14 530 99-0 Cover strip, 3000 mm	Black 10/100
	XTSP 11-3	64100 14 530 98-3 Cover strip, 3000 mm	White 10/100

Use of L- and T-accessories

Red line indicates polarity ridge

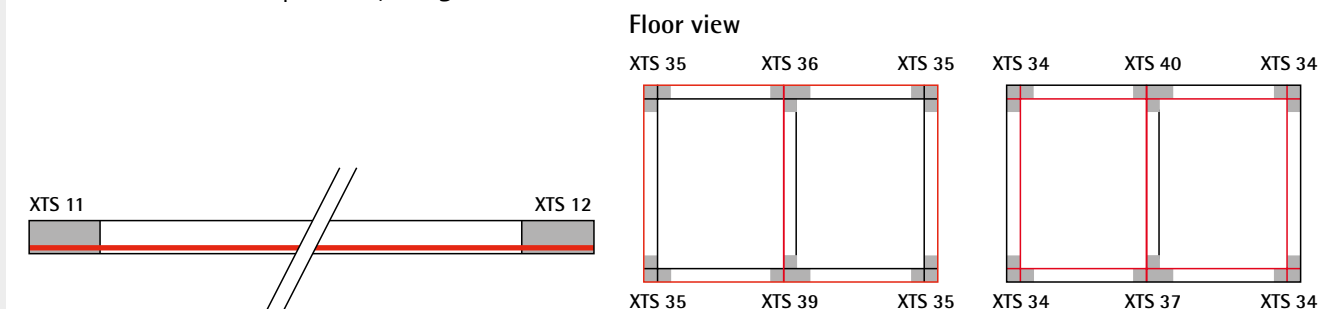



GLOBAL Trac Pulse control

GLOBAL Trac Pulse control is a lighting track system that includes both normal input voltage and wires for transmitting the control signal to the lights. This makes it possible to use smart control systems without central units. Of these, the DALI, DMX, LON and EIB standards are the most widely known. Various manufacturers provide control units, detectors and fixtures for the control systems. All control systems share the same goal: to transmit the control signal to individual lights using the GLOBAL Trac Pulse control's wires and to create dynamic lighting.



Needs-based lighting

Dynamic lighting means that the lighting changes according to the situation and need. Lights can be turned on and off, brightened or dimmed flexibly as separate groups. This also saves energy, because lights are only turned on where necessary.



Directing attention

Dynamic lighting is used to focus attention in store settings and shop windows. It is also used in museums and exhibitions to highlight details and in restaurants, auditoriums, hotel lobbies and many other places.



GLOBAL Trac Pulse control

L1/L2/L3/neutral/ground 16 A/400 V + control 3 x 1 A/50 V FELV AC DALI (FELV), DMX, LON, EIB, 1-10 V etc. compatible.

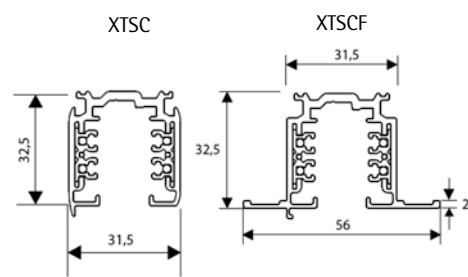
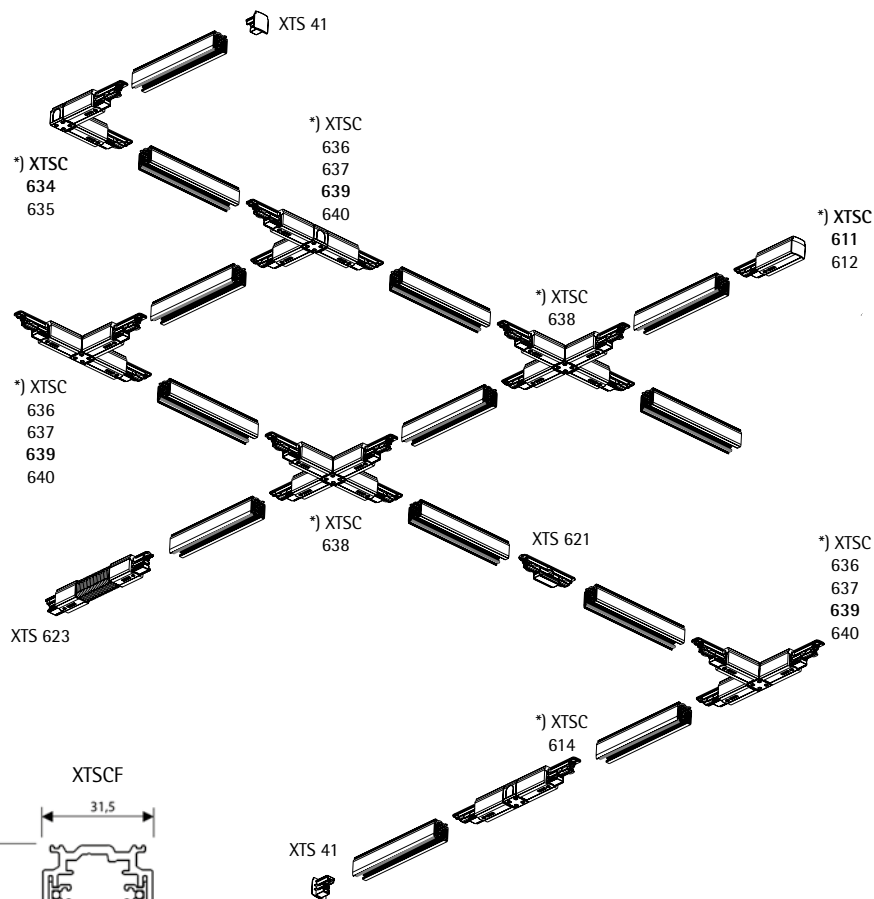

The recommended fastening distance is 1000 mm.
NOTE: A load not heavier than 10 kg may hang on a power takeoff adapter, the pull strength being 100 N (1kp = 9.81N) and the maximum torque 2.5 Nm. (GA 69 5 kg/50 N).

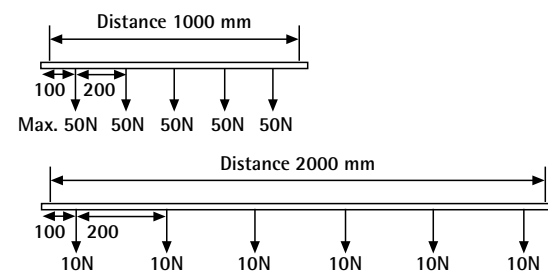

L/mm	a/mm	b/mm	c/mm	d/mm
1000	250			
2000	250	1000		
3000	250		1000	1000
4000	250		1500	1000

GLOBAL Trac Pulse control tracks

Available colours: -1 grey (AW202JR), -2 black (RAL 9005), -3 white (RAL 9010).

XTSC 6100-6400

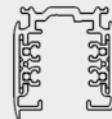

Type	EAN code	Dimensions in mm/ track length	Surface treatment/colour/ material	PCS/ Package
XTSC6100-1	64100 14 531 42-3	1000	grey	4/240
XTSC6100-2	64100 14 531 43-0	1000	black	4/240
XTSC6100-3	64100 14 531 47-8	1000	white	4/240
XTSC6200-1	64100 14 531 48-5	2000	grey	4/240
XTSC6200-2	64100 14 531 49-2	2000	black	4/240
XTSC6200-3	64100 14 531 50-8	2000	white	4/240
XTSC6300-1	64100 14 531 51-5	3000	grey	4/240
XTSC6300-2	64100 14 531 52-2	3000	black	4/240
XTSC6300-3	64100 14 531 53-9	3000	white	4/240
XTSC6400-1	64100 14 531 54-6	4000	grey	4/240
XTSC6400-2	64100 14 531 55-3	4000	black	4/240
XTSC6400-3	64100 14 531 56-0	4000	white	4/240
XTSCF6100-1	64100 14 531 57-7	1000	grey	6/180
XTSCF6100-2	64100 14 531 58-4	1000	black	6/180
XTSCF6100-3	64100 14 531 59-1	1000	white	6/180
XTSCF6200-1	64100 14 531 60-7	2000	grey	6/180
XTSCF6200-2	64100 14 531 61-4	2000	black	6/180
XTSCF6200-3	64100 14 531 62-1	2000	white	6/180
XTSCF6300-1	64100 14 531 63-8	3000	grey	6/180
XTSCF6300-2	64100 14 531 64-5	3000	black	6/180
XTSCF6300-3	64100 14 531 68-3	3000	white	6/180
XTSCF6400-1	64100 14 531 69-0	4000	grey	6/180
XTSCF6400-2	64100 14 531 70-6	4000	black	6/180
XTSCF6400-3	64100 14 531 71-3	4000	white	6/180

XTSCF 6100-6400

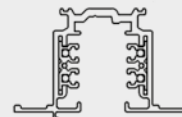

GLOBAL Trac Pulse control accessories

Power supply in all connectors except XTS(C)621 and XTS(C)623. All materials used are halogen free and V0-self-extinguishing.
Available colours: -1 grey (RAL 7040), -2 black (RAL 9005), -3 white (RAL 9010).

End feed XTSC 611

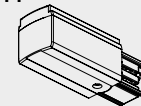

XTSC 612

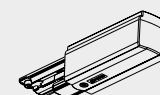

Type	EAN code	Polarity ridge	Surface treatment/colour/ material	PCS/ Package
XTSC611-1	64100 14 532 37-6		grey	5/50
XTSC611-2	64100 14 532 38-3		black	5/50
XTSC611-3	64100 14 532 39-0		white	5/50
XTSC612-1	64100 14 532 40-6		grey	5/50
XTSC612-2	64100 14 532 41-3		black	5/50
XTSC612-3	64100 14 532 42-0		white	5/50



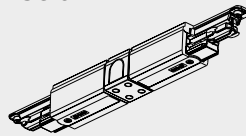
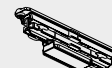
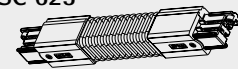
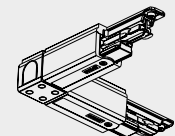
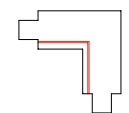
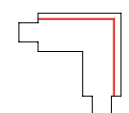
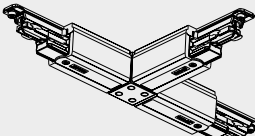
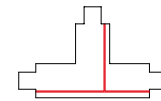
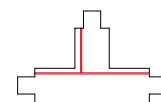
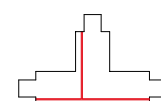
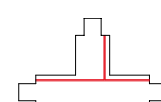
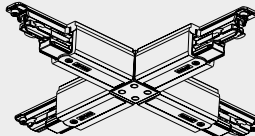
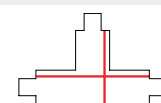
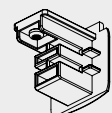

GLOBAL Trac Pulse control accessories

Power supply in all connectors except XTS(C)621 and XTS(C)623.
Available colours: -1 grey (RAL 7040), -2 black (RAL 9005), -3 white (RAL 9010).
All materials used are halogen free and VO-self-extinguishing.

	Type	EAN code	Polarity ridge	Surface treatment/colour/material	PCS/Package
Middle feed XTSC 614 	XTSC614-1	64100 14 532 44-4		grey	5/25
	XTSC614-2	64100 14 532 45-1		black	5/25
	XTSC614-3	64100 14 532 46-8		white	5/25
Straight connector XTSC 621 	XTS(C)621-1	64100 14 532 10-9		grey	10/100
	XTS(C)621-2	64100 14 532 11-6		black	10/100
	XTS(C)621-3	64100 14 532 12-3		white	10/100
Flexible corner connector XTSC 623 	XTS(C)623-1	64100 14 532 13-0		grey	5/25
	XTS(C)623-2	64100 14 532 14-7		black	5/25
	XTS(C)623-3	64100 14 532 15-4		white	5/25
L-feed XTSC 634, 635 	XTSC634-1	64100 14 532 47-5		grey	5/25
	XTSC634-2	64100 14 532 48-2		black	5/25
	XTSC634-3	64100 14 532 49-9		white	5/25
	XTSC635-1	64100 14 532 50-5		grey	5/25
	XTSC635-2	64100 14 532 51-2		black	5/25
	XTSC635-3	64100 14 532 55-0		white	5/25
T-feed XTSC 636, 637, 639, 640 	XTSC636-1	64100 14 532 56-7		grey	1/20
	XTSC636-2	64100 14 532 57-4		black	1/20
	XTSC636-3	64100 14 532 58-1		white	1/20
	XTSC637-1	64100 14 532 59-8		grey	1/20
	XTSC637-2	64100 14 532 60-4		black	1/20
	XTSC637-3	64100 14 532 63-5		white	1/20
	XTSC639-1	64100 14 532 69-7		grey	1/20
	XTSC639-2	64100 14 532 70-3		black	1/20
	XTSC639-3	64100 14 532 71-0		white	1/20
	XTSC640-1	64100 14 532 72-7		grey	1/20
	XTSC640-2	64100 14 532 73-4		black	1/20
	XTSC640-3	64100 14 532 74-1		white	1/20
X-feed XTSC 638 	XTSC638-1	64100 14 532 64-2		grey	1/10
	XTSC638-2	64100 14 532 65-9		black	1/10
	XTSC638-3	64100 14 532 66-6		white	1/10
End cap XTS 41 	XTS41-1	64100 14 507 32-9		grey	10/100
	XTS41-2	64100 14 506 41-4		black	10/100
	XTS41-3	64100 14 507 41-1		white	10/100

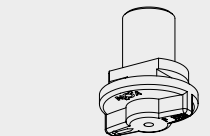
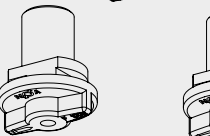
GLOBAL Trac Pulse control accessories

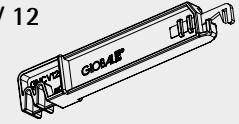
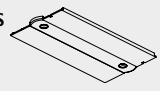
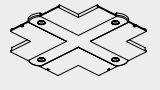
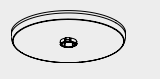
Available colours: -1 grey (RAL 7040), -2 black (RAL 9005), -3 white (RAL 9010).

	Type	EAN code		Surface treatment/colour/material	PCS/Package
Hook base XTAK 142, 144, 146 	XTAK142-1	64100 14 507 43-5	For 2 mm wire/hook	Grey	50/250
	XTAK142-2	64100 14 506 42-1	For 2 mm wire/hook	Black	50/250
	XTAK142-3	64100 14 507 42-8	For 2 mm wire/hook	White	50/250
	XTAK144-1	64100 14 507 45-9	For M4 nut/rod	Grey	50/250
	XTAK144-2	64100 14 506 44-5	For M4 nut/rod	Black	50/250
	XTAK144-3	64100 14 507 44-2	For M4 nut/rod	White	50/250
Hook XTAK 11 	XTAK146-1	64100 14 507 47-3	For M6 nut/rod	Grey	50/250
	XTAK146-2	64100 14 506 46-9	For M6 nut/rod	Black	50/250
	XTAK146-3	64100 14 507 46-6	For M6 nut/rod	White	50/250
Tool XTSV 12 	XTAK11-1	64100 14 500 79-5	Hook 2 mm	Steel	100/5000
	XTSV12	64100 14 500 99-3	Bending tool for power wires	Blue	1/100
	Cover plates XTSF 610 	XTSF610-1	64100 14 532 77-2	Cover plate for XTSC611-614	grey
XTSF610-2		64100 14 532 80-2	Cover plate for XTSC611-614	black	1/100
XTSF610-3		64100 14 532 81-9	Cover plate for XTSC611-614	white	1/100
XTSF 630 	XTSF630-1	64100 14 532 82-6	Cover plate for XTSC634-640	grey	1/100
	XTSF630-2	64100 14 532 83-3	Cover plate for XTSC634-640	black	1/100
	XTSF630-3	64100 14 532 84-0	Cover plate for XTSC634-640	white	1/100
XTSF 40 	XTSF40-1	64100 14 506 43-6	Outlet/cover plate for feeds	Grey	1/100
	XTSF40-2	64100 14 506 63-6	Outlet/cover plate for feeds	Black	1/100
	XTSF40-3	64100 14 507 63-3	Outlet/cover plate for feeds	White	1/100
Cover strip XTSP 11 	XTSP11-2	64100 14 530 99-0	Cover strip, 3000 mm	Black	10/100
	XTSP11-3	64100 14 530 98-3	Cover strip, 3000 mm	White	10/100

Use of L- and T-accessories

Red line indicates ground polarity ridge

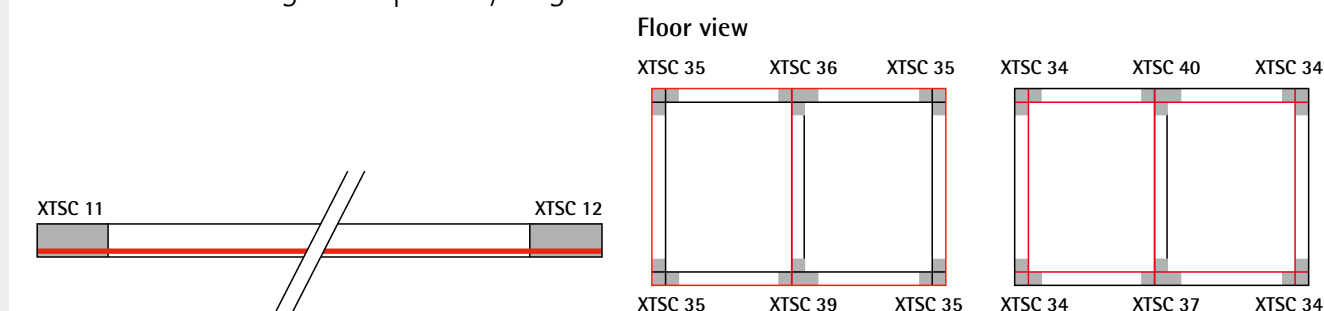



GLOBAL Trac Base

GLOBAL Trac Base is a compact, elegant-looking one-circuit basic track. The compact track is light to handle and simple to install. Diverse installation options are part of the package. Quick and easy installation results in overall cost savings.



From homes to exhibition stands

GLOBAL Trac Base is for places where the discrete and elegant appearance of the one-circuit track is most useful: homes, shop windows and exhibition structures.



Recessed version also available

There is a recessed version of GLOBAL Trac Base for suspended ceilings, too. The standard colours are grey, white and black.



Easy connection

GLOBAL Trac Base connectors are quick and easy to mount. The connectors and other accessories are reliable, and the customer can trust that the installation goes nice and smoothly.



GLOBAL Trac Base

L1/16 A/230 V. IP20.

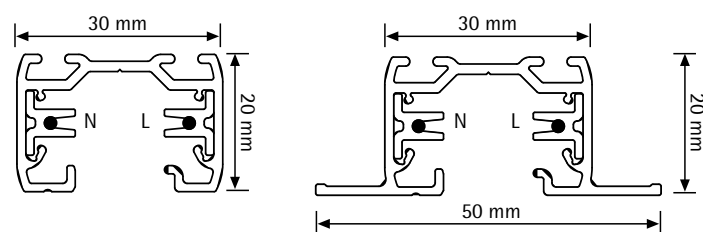
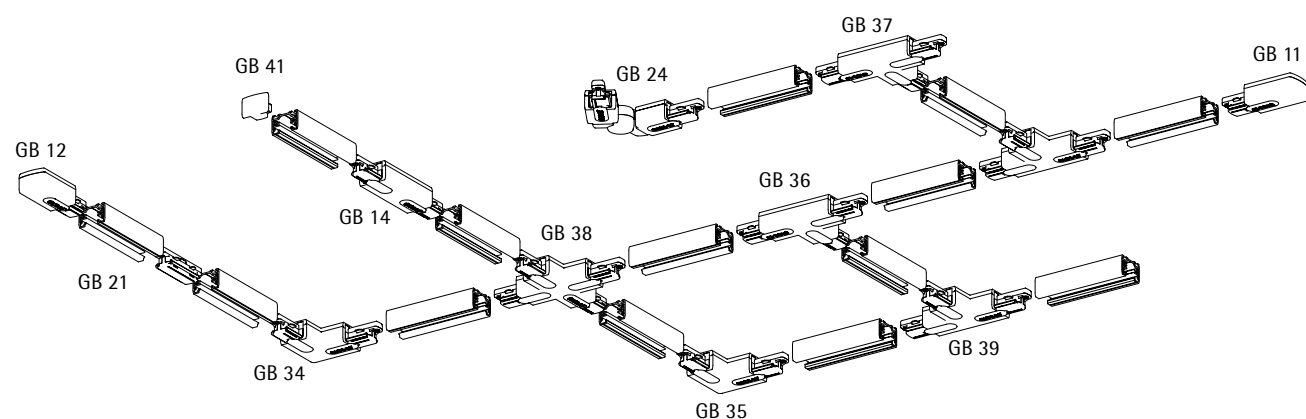

The recommended fastening distance is 1000 mm.
 NOTE: A load not heavier than 10 kg may hang on a power takeoff adapter, the pull strength being 100 N (1kp = 9.81N) and the maximum torque 2.5 Nm. (GB 66 5 kg/50 N).

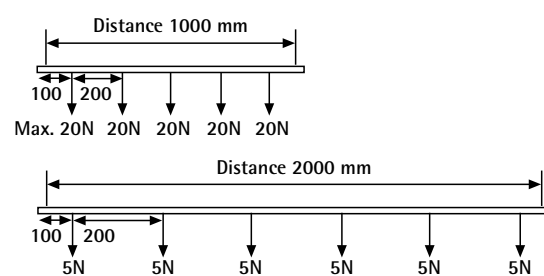

L/mm	a/mm	b/mm	c/mm	d/mm
1000	250			
2000	250	1000		
3000	250		1000	1000

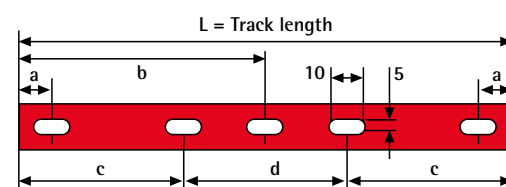

GLOBAL Trac Base tracks

Available colours: -1 grey (AW202JR), -2 black (RAL 9005), -3 white (RAL 9010).

GB
2100-2300

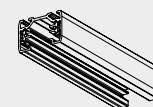

Type	EAN code	Dimensions in mm/ track length	Surface treatment/colour/ material	PCS/ Package
GB 2100-1	64100 14 509 01-9	1000	Grey	8/480
GB 2100-2	64100 14 508 01-2	1000	Black	8/480
GB 2100-3	64100 14 509 06-4	1000	White	8/480
GB 2200-1	64100 14 509 02-6	2000	Grey	8/480
GB 2200-2	64100 14 508 02-9	2000	Black	8/480
GB 2200-3	64100 14 509 07-1	2000	White	8/480
GB 2300-1	64100 14 509 03-3	3000	Grey	8/480
GB 2300-2	64100 14 508 03-6	3000	Black	8/480
GB 2300-3	64100 14 509 08-8	3000	White	8/480

GBF
2100-2300

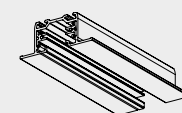

GBF 2100-1	64100 14 509 86-6	1000	Grey	6/180
GBF 2100-2	64100 14 508 91-3	1000	Black	6/180
GBF 2100-3	64100 14 509 91-0	1000	White	6/180
GBF 2200-1	64100 14 509 87-3	2000	Grey	6/180
GBF 2200-2	64100 14 508 92-0	2000	Black	6/180
GBF 2200-3	64100 14 509 92-7	2000	White	6/180
GBF 2300-1	64100 14 509 88-0	3000	Grey	6/180
GBF 2300-2	64100 14 508 93-7	3000	Black	6/180
GBF 2300-3	64100 14 509 93-4	3000	White	6/180

GLOBAL Track Base accessories

Power supply option in all connectors except GB 21 ja GB 24. All materials used are halogen free and VO-self-extinguishing.
 Available colours: -1 grey (RAL 7040), -2 black (RAL 9005), -3 white (RAL 9010).

End feed
GB 11

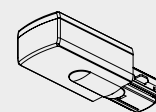

GB 12

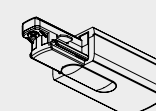

Type	EAN code	Polarity groove	Surface treatment/colour/ material	PCS/ Package
GB 11-1	64100 14 509 15-6		Grey	10/100
GB 11-2	64100 14 508 11-1		Black	10/100
GB 11-3	64100 14 509 11-8		White	10/100
GB 12-1	64100 14 509 16-3		Grey	10/100
GB 12-2	64100 14 508 12-8		Black	10/100
GB 12-3	64100 14 509 12-5		White	10/100

GLOBAL Trac Base accessories

Power supply option in all connectors except GB 21 ja GB 24.
Available colours: -1 grey (RAL 7040), -2 black (RAL 9005), -3 white (RAL 9010).

Type	EAN code	Polarity groove	Surface treatment/colour/material	PCS/Package
Middle feed GB 14	GB 14-1		Grey	5/50
	GB 14-2		Black	5/50
	GB 14-3		White	5/50
Straight connector GB 21	GB 21-1		Grey	10/100
	GB 21-2		Black	10/100
	GB 21-3		White	10/100
Adjustable corner connector GB 24	GB 24-1		Grey	5/25
	GB 24-2		Black	5/25
	GB 24-3		White	5/25
L-feed GB 34, 35	GB 34-1		Grey	5/25
	GB 34-2		Black	5/25
	GB 34-3		White	5/25
	GB 35-1		Grey	5/25
	GB 35-2		Black	5/25
	GB 35-3		White	5/25
T-feed GB 36, 37, 39, 40	GB 36-1		Grey	5/25
	GB 36-2		Black	5/25
	GB 36-3		White	5/25
	GB 37-1		Grey	5/25
	GB 37-2		Black	5/25
	GB 37-3		White	5/25
	GB 39-1		Grey	5/25
	GB 39-2		Black	5/25
	GB 39-3		White	5/25
GB 40-1		Grey	5/25	
GB 40-2		Black	5/25	
GB 40-3		White	5/25	
X-feed GB 38	GB 38-1		Grey	5/25
	GB 38-2		Black	5/25
	GB 38-3		White	5/25
End cap GB 41	GB 41-1		Grey	10/100
	GB 41-2		Black	10/100
	GB 41-3		White	10/100

GLOBAL Trac Base other parts

Available colours: -1 grey (RAL 7040), -2 black (RAL 9005), -3 white (RAL 9010).

Type	EAN code		Surface treatment/colour/material	PCS/Package
Hook base GBA 14	GBA 14-1	For 2 mm hook	Grey	50/250
	GBA 14-2	For 2 mm hook	Black	50/250
	GBA 14-3	For 2 mm hook	White	50/250
XTAK 11-1	64100 14 500 79-5	Hook 2 mm	Steel	100/5000
Outlet cover plate GBF 10	GBF 10-2	Cover plate for GB11-14	Black	1/100
	GBF 10-3	Cover plate for GB11-14	White	1/100
GBF 30	GBF 30-2	Cover plate for GB34-40	Black	1/100
	GBF 30-3	Cover plate for GB34-40	White	1/100

Use of L- and T-accessories

Red line indicates ground polarity groove

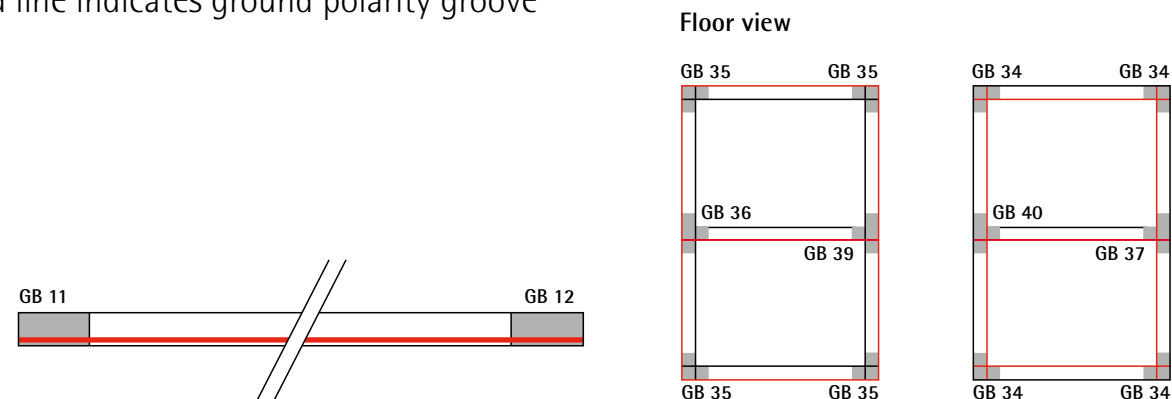

GLOBAL Trac suspension parts

GLOBAL Trac Pro, GLOBAL Pulse control

Straight

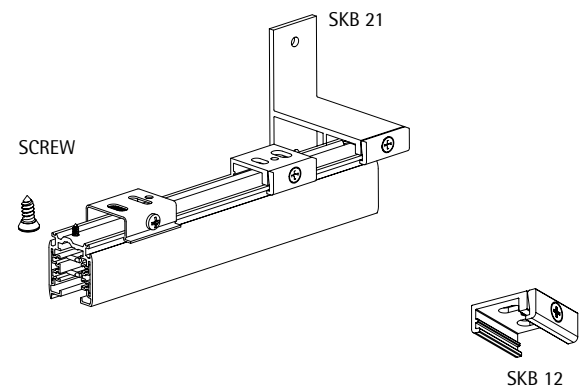

Rod suspension

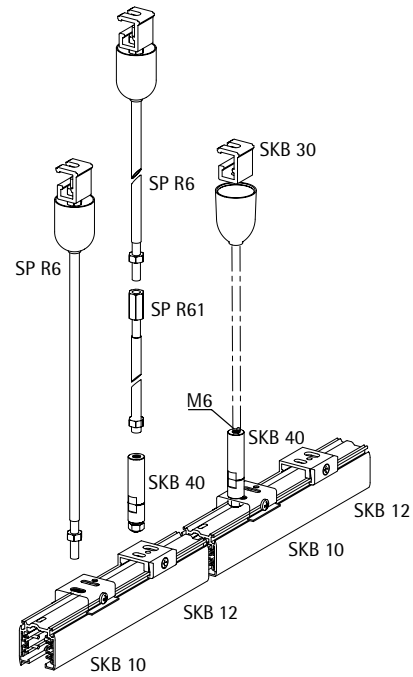

GLOBAL Trac Base

Straight

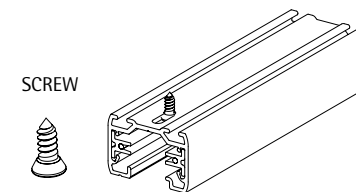

Rod suspension

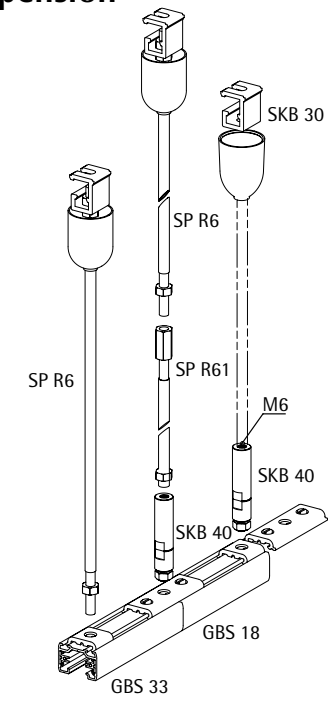

Wire suspension

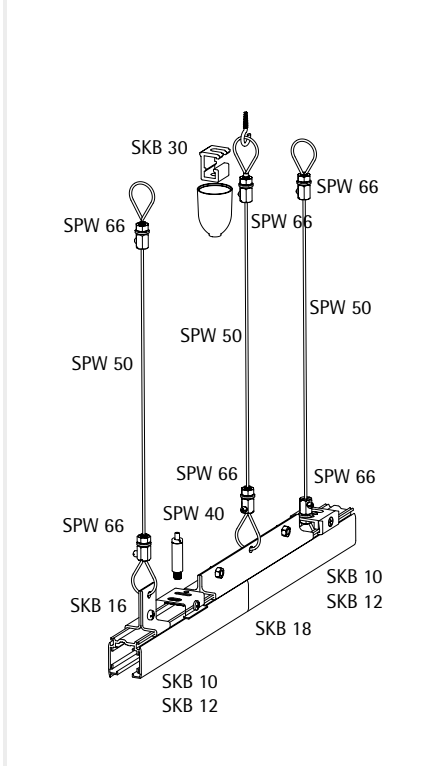
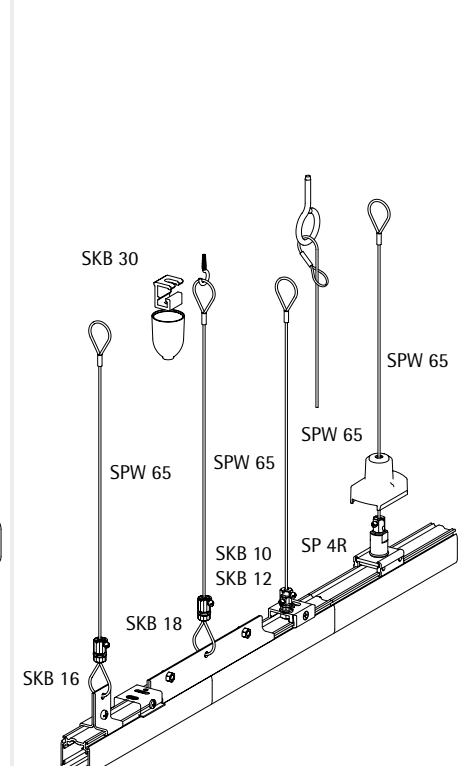
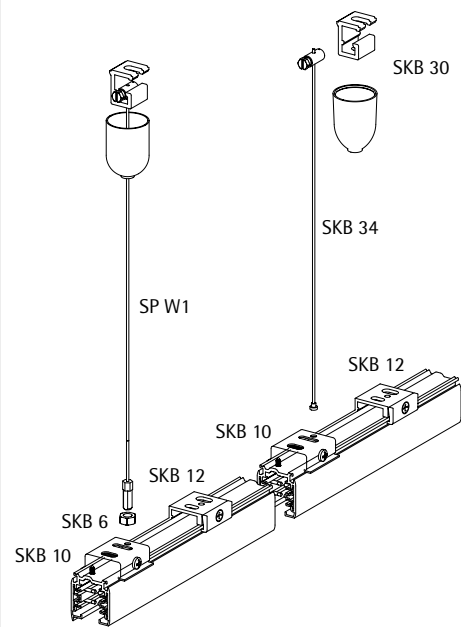



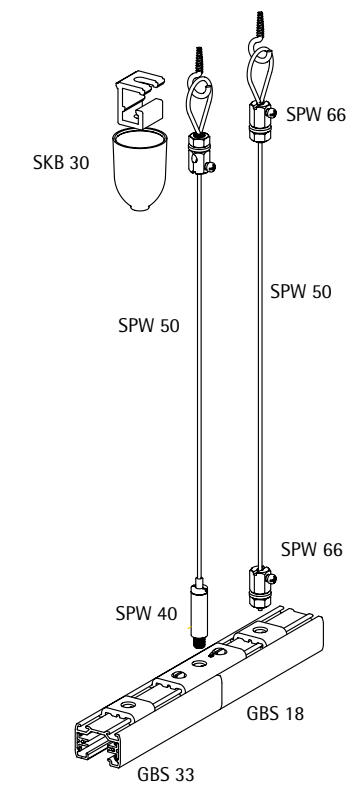
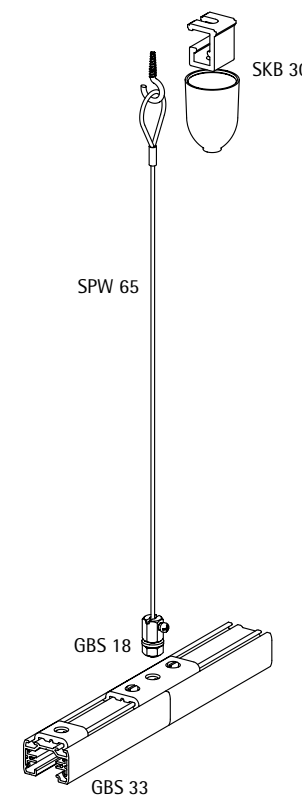



Wire suspension

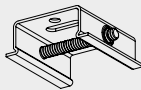
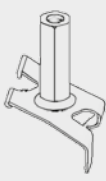
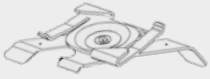

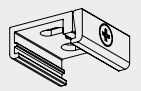
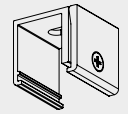
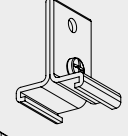
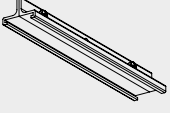
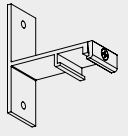
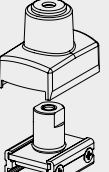
GLOBAL Trac suspension parts

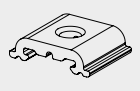
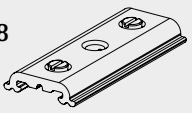
Available colours for parts: -1 grey (AW 202JR), -2 black (RAL 9005), -3 white (RAL 9010).

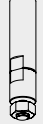
GLOBAL Trac Pro GLOBAL Trac Pulse control	Type	EAN code	Descr.	Colour	PCS/ Package
Track clamp					
	SKB10-1	64100 14 500 52-8	Fast mounting clamp, Fmax 200N	Steel	20/200
	SKB10-2	64100 14 520 52-6	Fast mounting clamp, Fmax 200N	Black	20/200
	SKB10-3	64100 14 530 52-5	Fast mounting clamp, Fmax 200N	White	20/200
	SKB11R-1	64100 14 500 66-5	Snap-on clamp for M6 rod, Fmax 150N	grey	20/200
	SKB11R-2	64100 14 500 67-2	Snap-on clamp for M6 rod, Fmax 150N	black	20/200
	SKB11R-3	64100 14 500 68-9	Snap-on clamp for M6 rod, Fmax 150N	white	20/200
	SKB11T-1	64100 14 500 60-3	Snap-on clamp for T-bar, Fmax 50N	grey	20/200
	SKB11T-2	64100 14 500 61-0	Snap-on clamp for T-bar, Fmax 50N	black	20/200
	SKB11T-3	64100 14 500 62-7	Snap-on clamp for T-bar, Fmax 50N	white	20/200
	SKB11WL-1	64100 14 500 63-4	Snap-on clamp for dia 1.5mm wire, Fmax 150N	grey	20/200
	SKB11WL-2	64100 14 500 64-1	Snap-on clamp for dia 1.5mm wire, Fmax 150N	black	20/200
	SKB11WL-3	64100 14 500 65-8	Snap-on clamp for dia 1.5mm wire, Fmax 150N	white	20/200
SKB 12 	SKB12-1	64100 14 500 51-1	Standard clamp, Fmax 200N	Grey	20/200
	SKB12-2	64100 14 520 56-4	Standard clamp, Fmax 200N	Black	20/200
	SKB12-3	64100 14 530 51-8	Standard clamp, Fmax 200N	White	20/200
SKB 12H 	SKB12H-1	64100 14 522 62-9	Standard clamp, height 29mm, Fmax 200N	Grey	100
	SKB12H-2	64100 14 522 63-6	Standard clamp, height 29mm, Fmax 200N	Black	100
	SKB12H-3	64100 14 522 64-3	Standard clamp, height 29mm, Fmax 200N	White	100
SKB 16 	SKB16-1	64100 14 500 53-5	Suspension clamp for track, Fmax 200N	Grey	20/200
	SKB16-2	64100 14 522 65-0	Suspension clamp track, Fmax 200N	Black	20/200
	SKB16-3	64100 14 530 53-2	Suspension clamp track, Fmax 200N	White	20/200
SKB 18 	SKB18-1	64100 14 500 55-9	Suspension clamp for track connection, Fmax 200N	Grey	10/50
	SKB18-2	64100 14 522 66-7	Suspension clamp for track connection, Fmax 200N	Black	10/50
	SKB18-3	64100 14 530 55-6	Suspension clamp for track connection, Fmax 200N	White	10/50
SKB 21 	SKB21-1	64100 14 500 74-0	Wall clamp, Fmax 100N	Grey	5/50
Other suspension parts					
SP 4R 	SP 4R-1	64100 14 507 68-8	Point clamp suspension for M6, Fmax 200N	Grey	10/100
	SP 4R-2	64100 14 506 91-9	Point clamp suspension for M6, Fmax 200N	Black	10/100
	SP 4R-3	64100 14 507 91-6	Point clamp suspension for M6, Fmax 200N	White	10/100

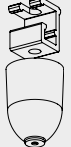
GLOBAL Trac Base	Type	EAN code	Descr.	Colour	PCS/ Package
Track clamp					
GBS 33 	GBS 33-9	64100 14 508 33-3	Suspension clamp for track, Fmax 200N	Anodised	20/200
GBS 18 	GBS 18-9	64100 14 508 18-0	Suspension clamp for track connection, Fmax 200N	Anodised	10/100
General parts					
SPR 6 	SPR 6-2	64100 14 506 87-2	Rod suspension set 1000mm, Fmax 200N	Black	10
	SPR 6-3	64100 14 507 87-9	Rod suspension set 1000mm, Fmax 200N	White	10
SPR 61 	SPR 61-2	64100 14 506 90-2	Rod extension set 1000mm, Fmax 200N	Black	10
	SPR 61-3	64100 14 507 90-9	Rod extension set 1000mm, Fmax 200N	White	10
SKB 40 	SKB 40-1	64100 14 502 48-5	Height adjusting sleeve for M6 rod, Fmax 200N	Steel	10/200
SPW 40 	SPW 40-1	64100 14 502 49-2	Fast height adjusting sleeve for 1.5 mm wire, Fmax 150N	Steel	10/200
SPW 66 	SPW 66-1	64100 14 535 16-2	Height adjusting sleeve for 1.5mm wire, Fmax 150N	Steel	100/1000
Mounting accessories					
SKB 30 	SKB 30-1	64100 14 522 74-2	Ceiling clamp with cup, Fmax 200N	Grey	10/200
	SKB 30-2	64100 14 502 44-7	Ceiling clamp with cup, Fmax 200N	Black	10/200
	SKB 30-3	64100 14 530 30-3	Ceiling clamp with cup, Fmax 200N	White	10/200



GLOBAL Trac suspension parts

Available colours for parts: -1 grey (RAL 7040), -2 black (RAL 9005), -3 white (RAL 9010).

SKB 34	Type	EAN code	Length	Information	Colour	PCS/ Package
	SKB34-1	64100 14 502 34-8	1.5	Fmax 150N	Steel	10/200
	SKB34-1/3M	64100 14 522 67-4	3	Fmax 150N	Steel	10/200
	SKB34-1/5M	64100 14 522 68-1	5	Fmax 150N	Steel	10/200
	SPW65-1	64100 14 533 15-1	1.5	Fmax 150N	Steel	10/100
	SPW50-1	64100 14 502 50-8	50	Fmax 150N	Steel	1/10
	SPW1-1	64100 14 522 69-8	1.5	Fmax 150N	Grey	10/100
	SPW1-1/3M	64100 14 500 47-4	3	Fmax 150N	Grey	10/100
	SPW1-1/5M	64100 14 500 48-1	5	Fmax 150N	Grey	10/100
	SPW1-2	64100 14 506 86-5	1.5	Fmax 150N	Black	10/100
	SPW1-2/3M	64100 14 522 70-4	3	Fmax 150N	Black	10/100
	SPW1-2/5M	64100 14 522 71-1	5	Fmax 150N	Black	10/100
	SPW1-3	64100 14 507 86-2	1.5	Fmax 150N	White	10/100
	SPW1-3/3M	64100 14 522 72-8	3	Fmax 150N	White	10/100
SPW1-3/5M	64100 14 522 73-5	5	Fmax 150N	White	10/100	

GLOBAL Trac suspension sets

GLOBAL Trac Pro, GLOBAL Trac Pulse control

	Type	EAN code	Length	Information	Clamp	Colour	PCS/ Package
	SPW10SK-1/1.5M	64100 14 522 93-3	1.5	Suspension wire set, Fmax 150N	SKB10-1	Grey	10/100
	SPW10SK-1/3M	64100 14 500 00-9	3	Suspension wire set, Fmax 150N	SKB10-1	Grey	10/100
	SPW10SK-1/5M	64100 14 500 01-6	5	Suspension wire set, Fmax 150N	SKB10-1	Grey	10/100
	SPW10SK-2/1.5M	64100 14 522 94-0	1.5	Suspension wire set, Fmax 150N	SKB10-2	Black	10/100
	SPW10SK-2/3M	64100 14 500 02-3	3	Suspension wire set, Fmax 150N	SKB10-2	Black	10/100
	SPW10SK-2/5M	64100 14 500 03-0	5	Suspension wire set, Fmax 150N	SKB10-2	Black	10/100
	SPW10SK-3/1.5M	64100 14 522 95-7	1.5	Suspension wire set, Fmax 150N	SKB10-3	White	10/100
	SPW10SK-3/3M	64100 14 500 04-7	3	Suspension wire set, Fmax 150N	SKB10-3	White	10/100
	SPW10SK-3/5M	64100 14 500 05-4	5	Suspension wire set, Fmax 150N	SKB10-3	White	10/100
		SPW11SK-1/1.5M	64100 14 500 69-6	1.5	Snap-on suspension wire set, Fmax 150N	SKB11-1	Grey
SPW11SK-1/3M		64100 14 500 76-4	3	Snap-on suspension wire set, Fmax 150N	SKB11-1	Grey	10/100
SPW11SK-1/5M		64100 14 500 82-5	5	Snap-on suspension wire set, Fmax 150N	SKB11-1	Grey	10/100
SPW11SK-2/1.5M		64100 14 500 71-9	1.5	Snap-on suspension wire set, Fmax 150N	SKB11-2	Black	10/100
SPW11SK-2/3M		64100 14 500 77-1	3	Snap-on suspension wire set, Fmax 150N	SKB11-2	Black	10/100
SPW11SK-2/5M		64100 14 500 83-2	5	Snap-on suspension wire set, Fmax 150N	SKB11-2	Black	10/100
SPW11SK-3/1.5M		64100 14 500 73-3	1.5	Snap-on suspension wire set, Fmax 150N	SKB11-3	White	10/100
SPW11SK-3/3M		64100 14 500 78-8	3	Snap-on suspension wire set, Fmax 150N	SKB11-3	White	10/100
SPW11SK-3/5M		64100 14 500 84-9	5	Snap-on suspension wire set, Fmax 150N	SKB11-3	White	10/100
	SPW12SK-1/1.5M	64100 14 522 96-4	1.5	Suspension wire set, Fmax 150N	SKB12-1	Grey	10/100
	SPW12SK-1/3M	64100 14 500 06-1	3	Suspension wire set, Fmax 150N	SKB12-1	Grey	10/100
	SPW12SK-1/5M	64100 14 500 07-8	5	Suspension wire set, Fmax 150N	SKB12-1	Grey	10/100
	SPW12SK-2/1.5M	64100 14 522 97-1	1.5	Suspension wire set, Fmax 150N	SKB12-2	Black	10/100
	SPW12SK-2/3M	64100 14 500 08-5	3	Suspension wire set, Fmax 150N	SKB12-2	Black	10/100
	SPW12SK-2/5M	64100 14 500 09-2	5	Suspension wire set, Fmax 150N	SKB12-2	Black	10/100
	SPW12SK-3/1.5M	64100 14 522 98-8	1.5	Suspension wire set, Fmax 150N	SKB12-3	White	10/100
	SPW12SK-3/3M	64100 14 500 10-8	3	Suspension wire set, Fmax 150N	SKB12-3	White	10/100
	SPW12SK-3/5M	64100 14 500 11-5	5	Suspension wire set, Fmax 150N	SKB12-3	White	10/100



GLOBAL Trac adapters

The GA 100 MULTI Adapter™, designed by Nordic Aluminium, represents the latest innovation in adapter technology. There are no delays in the phase selector switch in the transition from one phase to another. The phase selector switch at the side of the adapter makes the use comfortable. Because both ends of the adapter are fitted with a locking mechanism, it can be removed directly from the track without turning it.



Adapter for all lighting tracks

MULTI Adapters are also designed to work with other manufacturers' lighting tracks. This means that the light manufacturer or fitter does not have to worry about the track on which the light will be mounted. Nordic Aluminium's three-circuit adapters include a wide selection of MULTI Adapters. The adapters come in three standard colours: grey, white and black. Adapters include several patented solutions. The materials used are halogen free and flame resistant.



Most popular adapter in the world

Our GA 69 MULTI Adapter is the world's most sold adapter. Its quality and reliability are unequalled. Product testing and 100% quality assurance are an integral part of Nordic Aluminium's strategy.



For all power supply needs

Continuous product development is essential for Nordic Aluminium. New products include a Schuko adapter. With this product the lighting track can be used for other power supply needs than lighting. It is a useful solution for meeting electricity needs in stores and small industrial premises.



3-circuit adapters

Available colours: -1 grey (RAL 7040), -2 black (RAL 9005), -3 white (RAL 9010).

GA 100

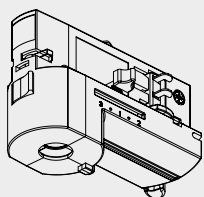

GA 100 circuit-selector adapter

Type	EAN code		Colour	PCS/ Package
GA 100-1	64100 14 530 00-6	MULTI Adapter	Grey	10/100
GA 100-2	64100 14 531 00-3	MULTI Adapter	Black	10/100
GA 100-3	64100 14 532 00-0	MULTI Adapter	White	10/100

Truly modular adapter: end cover can be changed to allow for GAC version or trafo box installations.

MULTI Adapter™

- 10 A, 250 V, Safety class I
- Max. pull strength 100 N
- Max. torque 2.5 Nm
- To be used with stranded wire 0.5 ...1 mm²

Slot connection. The conductors are pressed into the connectors by the cable mounting tool GB 66CT.

Type	EAN code		Colour	PCS/ Package
GA 100L-1		MULTI Adapter	Grey	100/3200
GA 100L-2		MULTI Adapter	Black	100/3200
GA 100L-3		MULTI Adapter	White	100/3200

CG 100	64100 14 530 79-2	Optional cable grip		100/5000
GB 66CT	64100 14 522 51-3	Slot connection tool		1/50

CG 100



GB 66CT

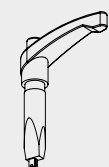

GAC 600

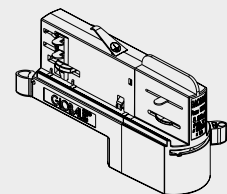

GAC600-1	64 100 14 532 92-5	Pulse control adapter	Grey	5/50
GAC600-2	64 100 14 532 93-2	Pulse control adapter	Black	5/50
GAC600-3	64 100 14 532 94-9	Pulse control adapter	White	5/50

GAC 600 LX

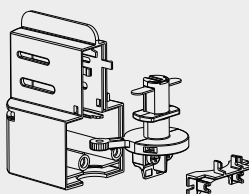

GAC600LX-1		Pulse control adapter, not preassembled	Grey	50
GAC600LX-2		Pulse control adapter, not preassembled	Black	50
GAC600LX-3		Pulse control adapter, not preassembled	White	50

GAC 69

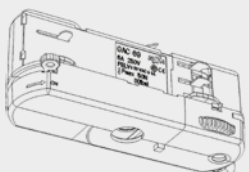

GAC 69-1		Pulse control adapter	Grey	1/50
GAC 69-2		Pulse control adapter	Black	1/50
GAC 69-3		Pulse control adapter	White	1/50
GAC 69L-1		Pulse control adapter	Grey	50
GAC 69L-2		Pulse control adapter	Black	50
GAC 69L-3		Pulse control adapter	White	50

GA 69

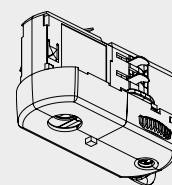

CG 69

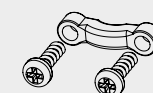

GA 69CT

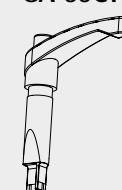

GAT 69

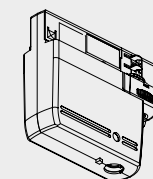

GAT 101

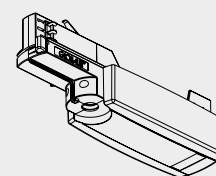

GAT 102

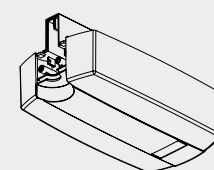

GA 69 circuit-selector adapter

Type	EAN code		Colour	PCS/ Package
GA 69-1	64100 14 530 74-7	MULTI Adapter	Grey	100/4800
GA 69-2	64100 14 520 69-4	MULTI Adapter	Black	100/4800
GA 69-3	64100 14 530 69-3	MULTI Adapter	White	100/4800

CG 69	64100 14 530 78-5	Optional cable grip		100/5000
GA 69CT	64100 14 522 52-0	Slot connection tool		1/100

MULTI Adapter™

- 6 A, 250 V, Safety class I
- Max. pull strength 50 N
- Max. torque 2.5 Nm
- To be used with stranded wire 0.5 ...1 mm²

Slot connection. The conductors are pressed into the connectors by the connector lid or by the cable mounting tool.

GAT 69 trafo housing adapter

Type	EAN code		Colour	PCS/ Package
GAT 69-1	64100 14 522 53-7		Grey	50
GAT 69-2	64100 14 522 54-4		Black	50
GAT 69-3	64100 14 522 55-1		White	50

MULTI Adapter™

- 6 A, 250 V, Safety class II
- Max. pull strength 50 N
- Max. torque 2.5 Nm
- To be used with stranded wire 0.5...1 mm²
- Delivered without transformer
- To be used only with a grounded transformer

GAT 101 and GAT 102 Multi Device Adapter

Type	EAN code		Colour	PCS/ Package
GAT 101-1		MULTI Device Adapter	Grey	1/25
GAT 101-2		MULTI Device Adapter	Black	1/25
GAT 101-3		MULTI Device Adapter	White	1/25

GA 100 adapter body included.

GAT 102-1		MULTI Device Adapter	Grey	25
GAT 102-2		MULTI Device Adapter	Black	25
GAT 102-3		MULTI Device Adapter	White	25

Note! To be ordered separately: GA 100 or GAC 600 adapter.

3-circuit adapters

Available colours: -1 grey (RAL 7040), -2 black (RAL 9005), -3 white (RAL 9010).

GA 300

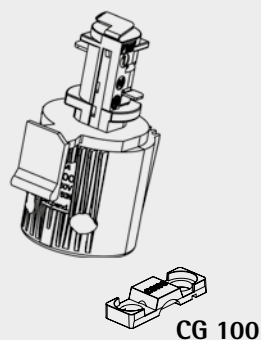

GA 300 circuit selector adapter. Phase 2 preselected.

Type	EAN code	Colour	PCS/ Package
GA300-1	64100 14 530 43-3	Grey	10/100
GA300-2	64100 14 530 44-0	Black	10/100
GA300-3	64100 14 530 45-7	White	10/100
GA300L-1	64100 14 530 46-4	Grey	100/4800
GA300L-2	64100 14 530 47-1	Black	100/4800
GA300L-3	64100 14 530 48-8	White	100/4800

- A discreet adapter for elegant housing solutions
- For GLOBAL Trac Pro XTS and XTSF tracs
- 3 A, 250 V, Safety class I
- Max pull strength 50 N
- Max torque 2.5 Nm
- To be used with stranded wire
- Cable Grip CG 100

Slot Connection. The conductors are pressed into the connectors by the Slot Plug (included) using for example a Torx 10 screwdriver.

GA 300PP

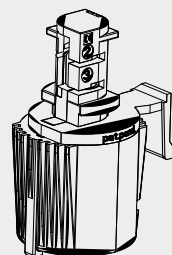

GA 300PP adapter, plastic parts.

Type	Colour	PCS/ Package
GA300PP-1	Grey	100
GA300PP-2	Black	100
GA300PP-3	White	100

- For customized solutions
- No metal connectors
- For mechanical support only

GA 300B

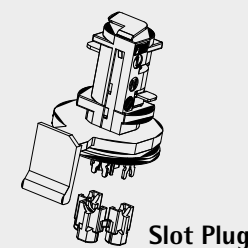

GA 300B Adapter body

Type	Colour	PCS/ Package
GA300B-1	Grey	100
GA300B-2	Black	100
GA300B-3	White	100

- For customized solutions

GA 300NB

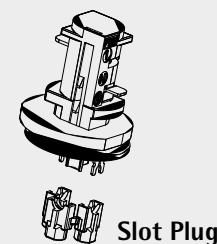

GA 300NB Adapter body

Type	Colour	PCS/ Package
GA300NB-1	Grey	100
GA300NB-2	Black	100
GA300NB-3	White	100

- For class II customized solutions
- No ground connector
- Without locking lever

3-circuit adapters

Available colours: -1 grey (RAL 7040), -2 black (RAL 9005), -3 white (RAL 9010).

XTSA 68

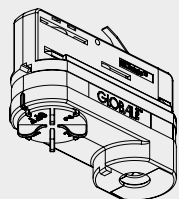

CG 75



XTSA 68 circuit-selector adapter

Type	EAN code	Colour	PCS/Package
XTSA 68-1	64100 14 530 73-0	Grey	10/100
XTSA 68-2	64100 14 520 68-7	Black	10/100
XTSA 68-3	64100 14 530 68-6	White	10/100
XTSA 68L-1		Grey	100/3200
XTSA 68L-2		Black	100/3200
XTSA 68L-3		White	100/3200

CG 75 64100 14 530 77-8 Optional cable grip 100/5000

MULTI Adapter™

- 10 A, 250 V, Safety class I
- Max. pull strength 100 N
- Max. torque 2.5 Nm
- Connecting conductors max. 3 x 1.5 mm²

Screw-in connection. The conductors are connected with screws.

XTSA 67

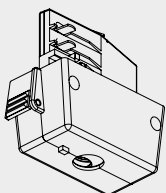

XTSA 67S

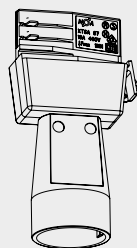

XTSA 67 power take-off adapter

Type	EAN code	Colour	PCS/Package
XTSA 67-1	64100 14 500 46-7	Grey	10/100
XTSA 67-2	64100 14 520 67-0	Black	10/100
XTSA 67-3	64100 14 530 67-9	White	10/100

XTSA 67S-3	64100 14 500 44-3	Black	5/50
XTSA 67S-3	64100 14 531 67-6	White	5/50

- For GLOBAL Trac Pro tracks XTS and XTSF tracks
- 16 A, 250 V/400 V, Safety class I
- Max. pull strength 100 N
- Max. torque 2.5 Nm
- Connecting conductors max. 5 x 2.5 mm²

Nipples for 3-circuit adapters

Available colours: -1 grey (RAL 7040), -2 black (RAL 9005), -3 white (RAL 9010), -9 aluminium.

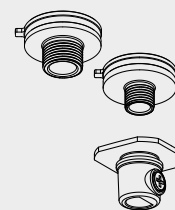

Fixed nipple

Type	EAN code	Thread	H mm	Ø mm	Colour	Strain relief	Suitable for adapter						PCS/Package	
							GA 69	GAT 69	GA 100	GAC 600	GA 300	XTSA 68		XTSA 67
XTS 56/8.6-9	64100 14 522 56-8	M13 x 1	8.6	9.0	Aluminium	XTSA 513	x	x	x	x	x	x	x	100/500
XTS 58/8-9	64100 14 501 71-6	M10 x 1	8.0	7.4	Aluminium	XTSA 510	x	x	x	x	x	x	x	100/500
GA 510-1	64100 14 500 34-4			7.0	Grey	Included	x	x	x	x	x	x	x	100/500
GA 510-2	64100 14 520 86-1			7.0	Black	Included	x	x	x	x		x	x	100/500
GA 510-3	64100 14 530 86-0			7.0	White	Included	x	x	x	x	x	x	x	100/500
Rotating nipple *)														
XTSA360/8-1	64100 14 500 18-4	M10 x 1	8.0	7.4	Grey	XTSA 510	x	x	x	x	x	x	x	100/500
XTSA360/8-2	64100 14 500 19-1	M10 x 1	8.0	7.4	Black	XTSA 510	x	x	x	x	x	x	x	100/500
XTSA360/8-3	64100 14 500 20-7	M10 x 1	8.0	7.4	White	XTSA 510	x	x	x	x	x	x	x	100/500
XTSA 360/12-1	64100 14 522 82-7	M10 x 1	12.0	7.4	Grey		x	x	x	x	x	x	x	100/500
XTSA 360/12-2	64100 14 522 83-4	M10 x 1	12.0	7.4	Black		x	x	x	x	x	x	x	100/500
XTSA 360/12-3	64100 14 522 84-1	M10 x 1	12.0	7.4	White		x	x	x	x	x	x	x	100/500
XTSA 55/12-9	64100 14 501 55-6	M13 x 1	12.0	9.0	Aluminium		x	x	x	x	x	x	x	100/500
XTSA 57/8-9	64100 14 501 59-4	M10 x 1	8.0	7.4	Aluminium	XTSA 510	x	x	x	x	x	x	x	100/500
XTSA 57/8-9DD	64100 14 522 58-2	M10 x 1	8.0	6.9	Aluminium	XTSA 510	x	x	x	x	x	x	x	100/500
XTSA 57/12-9	64100 14 501 57-0	M10 x 1	12.0	7.4	Aluminium		x	x	x	x	x	x	x	100/500
XTSA 57/12-2	64100 14 520 92-2	M10 x 1	12.0	7.4	Black		x	x	x	x	x	x	x	100/500
XTSA 57/17-9	64100 14 500 37-5	M10 x 1	17.0	7.4	Aluminium		x	x	x	x	x	x	x	100/500
XTSA 57T1/8-9	64100 14 500 38-2	M10 x 1	8.0	7.4	Aluminium	XTSA 510	x	x	x	x	x	x	x	100/500
XTSA 57T2/8-9	64100 14 500 39-2	M10 x 1	8.0	7.4	Aluminium	XTSA 510	x	x	x	x	x	x	x	100/500
XTSA 63-9	64100 14 522 59-9	M10 x 1			Aluminium		x	x	x	x	x	x	x	100/500
Nipple joint *)														
GA 37-1	64100 14 500 15-3			7.6	Grey		x	x	x	x	x	x	x	10/100
GA 37-2	64100 14 500 16-0			7.6	Black		x	x	x	x	x	x	x	10/100
GA 37-3	64100 14 500 17-7			7.6	White		x	x	x	x	x	x	x	10/100
GA 37M13-1	64100 14 500 27-6	M13 x 1	11	7.6	Grey	XTSA513	x	x	x	x	x	x	x	10/100
GA 37M13-2	64100 14 500 28-3	M13 x 1	11	7.6	Black	XTSA513	x	x	x	x	x	x	x	10/100
GA 37M13-3	64100 14 500 29-0	M13 x 1	11	7.6	White	XTSA513	x	x	x	x	x	x	x	10/100
Strain relief *)														
XTSA 510-1	64100 14 500 32-0	M10 x 1	9.0	9.2	Grey									100/500
XTSA 510-2	64100 14 520 90-8	M10 x 1	9.0	9.2	Black									100/500
XTSA 510-3	64100 14 530 90-7	M10 x 1	9.0	9.2	White									100/500
XTSA 513-1	64100 14 500 33-7	M13 x 1	9.0	9.2	Grey									100/500
XTSA 513-2	64100 14 520 91-5	M13 x 1	9.0	9.2	Black									100/500
XTSA 513-3	64100 14 530 91-4	M13 x 1	9.0	9.2	White									100/500
Thread														
GAM 10-9	64100 14 501 75-4	M10 x 1												100/500
GAM 13-9	64100 14 501 76-1	M13 x 1												100/500

*) Halogen free, V0-self-extinguishing.

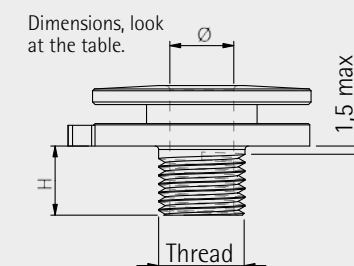

3-circuit adapter accessories

Available colours: -1 grey (RAL 7040), -2 black (RAL 9005), -3 white (RAL 9010).

GA 70

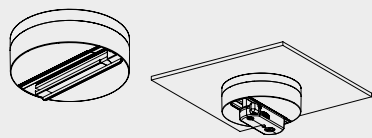

FIX Point™ adapter connector

Type	EAN code	Colour	PCS/Package
GA 70-1	64100 14 530 92-1	Grey	1/50
GA 70-2	64100 14 520 93-9	Black	1/50
GA 70-3	64100 14 530 93-8	White	1/50

- For GLOBAL 3-circuit adapters
- 10 A, 250 V, Safety class I
- Max. pull strength 50 N
- Max. torque 2.5 Nm
- For surface installation

GA 30



Type	EAN code	Colour	PCS/Package
GA30-1	64100 14 500 12-2	Grey	1/50
GA30-2	64100 14 500 13-9	Black	1/50
GA30-3	64100 14 500 14-6	White	1/50

- For GA300 adapter
- 3 A, 250 V, Safety class I
- Max. pull strength 50 N
- Max. torque 2.5 Nm
- For surface installation

XTSA 71

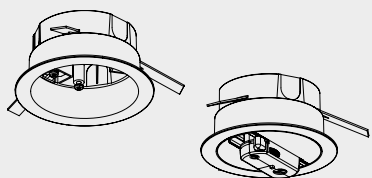

Recessed box

Type	EAN code	Colour	PCS/Package
XTSA 71-1	64100 14 530 97-6	Grey	1/25
XTSA 71-2	64100 14 520 96-0	Black	1/25
XTSA 71-3	64100 14 530 96-9	White	1/25

- For recessed installation with FIX Point™ GA 70
- Adjustable to different ceiling thicknesses, max. 30 mm
- For fixing hole diameters of Ø 105-125 mm

XTSK 17

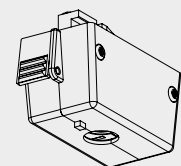

Clamps for fluorescent fitting to track

Type	EAN code	Colour	PCS/Package
XTSK 17-1		Grey	10/100
XTSK 17-2	64100 14 520 17-5	Black	10/100
XTSK 17-3	64100 14 530 17-4	White	10/100

XTAO 16

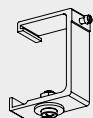

XTAO 16-1	64100 14 500 49-8	Aluminium	5/50
-----------	-------------------	-----------	------

GB 66

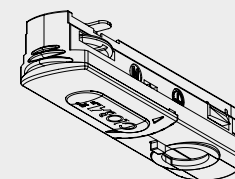

1-circuit adapters

Available colours: -1 grey (RAL 7040), -2 black (RAL 9005), -3 white (RAL 9010).

GB 66 adapter

Type	EAN code	Colour	PCS/Package
GB 66-1	64100 14 509 65-1	Grey	10/100
GB 66-2	64100 14 508 66-1	Black	10/100
GB 66-3	64100 14 509 66-8	White	10/100

GB 66L-1		Grey	100/9600
GB 66L-2		Black	100/9600
GB 66L-3		White	100/9600

GB 66CT	64100 14 522 51-3	Slot connection tool	1/50
---------	-------------------	----------------------	------

- 6 A, 250 V, Safety class I
- Max. pull strength 50 N
- Max. torque 2.5 Nm
- To be used with stranded wire 0.5 ... 1 mm²

Slot connection. The conductors are pressed into the connectors by the connector lid or by the cable mounting tool.

GB 67

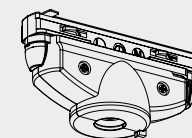

GB 67 adapter

Type	EAN code	Colour	PCS/Package
GB 67-1	64100 14 509 73-6	Grey	10/100
GB 67-2	64100 14 508 67-8	Black	10/100
GB 67-3	64100 14 509 67-5	White	10/100

GB 67L-1		Grey	100/4800
GB 67L-2		Black	100/4800
GB 67L-3		White	100/4800

GB 67M

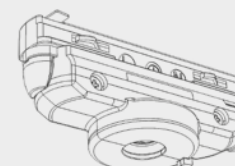

GB 67M-1		Grey	100
GB 67M-2		Black	100
GB 67M-3		White	100

GB 67S

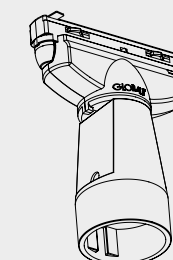

GB 67S-2	64100 14 500 45-0	Schuko adapter	White	1/50
GB 67S-3	64100 14 509 68-2	Schuko adapter	White	1/50

*) Cable grip CG 69 included

- 16 A, 250 V, Safety class
- Max. pull strength 100 N
- Max. torque 2.5 Nm
- Connecting conductors max. 3 x 2.5 mm²

Screw-in connection. The conductors are connected with screws.

1-circuit adapters

Available colours: -1 grey (RAL 7040), -2 black (RAL 9005), -3 white (RAL 9010).

GBB 67

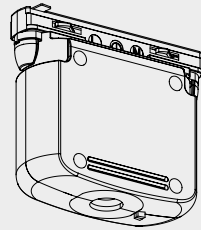

GBT 67 adapter

Type	EAN code	Colour	PCS/Package
GBT 67-1		Grey	20/960
GBT 67-2		Black	20/960
GBT 67-3		White	20/960

- Max. pull strength 100 N
- Max. torque 2.5 Nm
- Connecting conductors max. 3 x 1.5 mm²
- Suits for use with dimmable fittings

Nipples for 1-circuit adapters

Available colours: -1 grey (RAL 7040), -2 black (RAL 9005), -3 white (RAL 9010), -9 aluminium.

Type	EAN code	Thread	H mm	Ø mm	Colour	Strain relief	Suitable for adapter			PCS/Package
							GB 66	GB 67	GBB 67	
Fixed nipple										
XTS 56/8.6-9	64100 14 522 56-8	M13 x 1	8.6	9.0	Aluminium	XTSA 513		x	x	100/500
XTS 58/8-9	64100 14 501 71-6	M10 x 1	8.0	7.4	Aluminium	XTSA 510		x	x	100/500
GA 510-1	64100 14 500 34-4			7.0	Grey	Included		x	x	100/500
GA 510-2	64100 14 520 86-1			7.0	White	Included		x	x	100/500
GA 510-3	64100 14 530 86-0			7.0	White	Included		x	x	100/500
GB 510-1	64100 14 500 35-1			7.0	Grey	Included	x			100/500
GB 510-2	64100 14 508 58-6			7.0	Black	Included	x			100/500
GB 510-3	64100 14 509 58-3			7.0	White	Included	x			100/500
Rotating nipple *)										
XTSA 360/8-1	64100 14 500 18-4	M10 x 1	8.0	7.4	Grey	XTSA 510		x	x	100/500
XTSA 360/8-2	64100 14 500 19-1	M10 x 1	8.0	7.4	Black	XTSA 510		x	x	100/500
XTSA 360/8-3	64100 14 500 20-7	M10 x 1	8.0	7.4	White	XTSA 510		x	x	100/500
XTSA 360/12-1	64100 14 522 82-7	M10 x 1	12.0	7.4	Grey			x	x	100/500
XTSA 360/12-2	64100 14 522 83-4	M10 x 1	12.0	7.4	Black			x	x	100/500
XTSA 360/12-3	64100 14 522 84-1	M10 x 1	12.0	7.4	White			x	x	100/500
XTSA 55/12-9	64100 14 501 55-6	M13 x 1	12.0	9.0	Aluminium			x	x	100/500
XTSA 57/8-9	64100 14 501 59-4	M10 x 1	8.0	7.4	Aluminium	XTSA 510		x	x	100/500
XTSA 57/8-9DD	64100 14 522 58-2	M10 x 1	8.0	6.9	Aluminium	XTSA 510		x	x	100/500
XTSA 57/12-9	64100 14 501 57-0	M10 x 1	12.0	7.4	Aluminium			x	x	100/500
XTSA 57/12-2	64100 14 520 92-2	M10 x 1	12.0	7.4	Black			x	x	100/500
XTSA 57/17-9	64100 14 500 37-5	M10 x 1	17.0	7.4	Aluminium			x	x	100/500
XTSA 57T/8-9	64100 14 500 38-2	M10 x 1	8.0	7.4	Aluminium	XTSA 510		x	x	100/500
XTSA 57T/8-9	64100 14 500 39-2	M10 x 1	8.0	7.4	Aluminium	XTSA 510		x	x	100/500
XTSA 63-9	64100 14 522 59-9	M10 x 1			Aluminium			x	x	100/500
GA 57/10-1	64100 14 509 56-9	M10 x 1	10.0	7.0	Grey	XTSA 510		x		100/500
GA 57/10-2	64100 14 508 57-9	M10 x 1	10.0	7.0	Black	XTSA 510		x		100/500
GA 57/10-3	64100 14 509 57-6	M10 x 1	10.0	7.0	White	XTSA 510		x		100/500
GA 57/10-9	64100 14 508 97-5	M10 x 1	10.0	7.0	Aluminium	XTSA 510		x		100/500
GA 57/21-9		M10 x 1	21.0	7.0	Aluminium			x		100/500
Nipple joint *)										
GA37-1	64100 14 500 15-3			7.6	Grey			x	x	10/100
GA37-2	64100 14 500 16-0			7.6	Black			x	x	10/100
GA37-3	64100 14 500 17-7			7.6	White			x	x	10/100
GA37M13-1	64100 14 500 27-6	M13 x 1	11	7.6	Grey	XTSA 513		x	x	10/100
GA37M13-2	64100 14 500 28-3	M13 x 1	11	7.6	Black	XTSA 513		x	x	10/100
GA37M13-3	64100 14 500 29-0	M13 x 1	11	7.6	White	XTSA 513		x	x	10/100
Strain relief *)										
XTSA 510-1	64100 14 500 32-0	M10 x 1	9.0	9.2	Grey					100/500
XTSA 510-2	64100 14 520 90-8	M10 x 1	9.0	9.2	Black					100/500
XTSA 510-3	64100 14 530 90-7	M10 x 1	9.0	9.2	White					100/500
XTSA 513-1	64100 14 500 33-7	M13 x 1	9.0	9.2	Grey					100/500
XTSA 513-2	64100 14 520 91-5	M13 x 1	9.0	9.2	Black					100/500
XTSA 513-3	64100 14 530 91-4	M13 x 1	9.0	9.2	White					100/500
Thread										
GAM 10-9	64100 14 501 75-4	M10 x 1								100/500
GAM 13-9	64100 14 501 76-1	M13 x 1								100/500

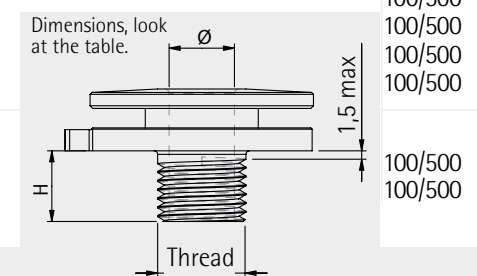

*) Halogen free, V0-self-extinguishing.

GLOBAL Trac connecting diagrams

GLOBAL Trac Pro

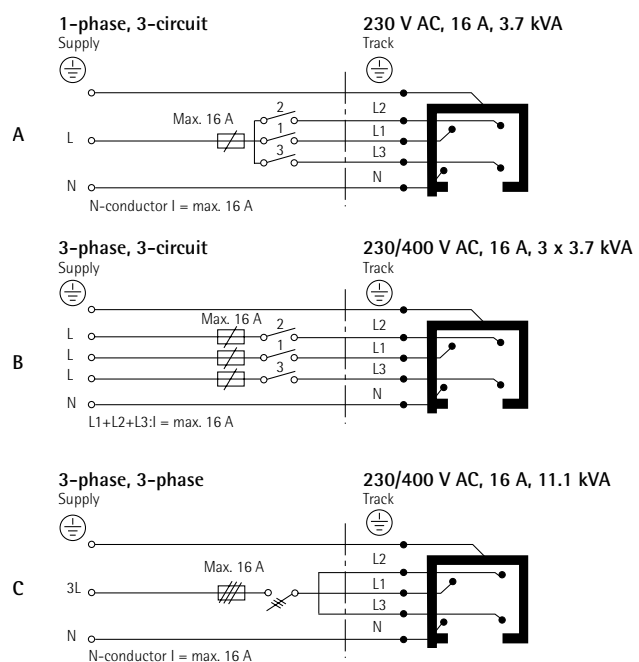

GLOBAL Trac Pulse control

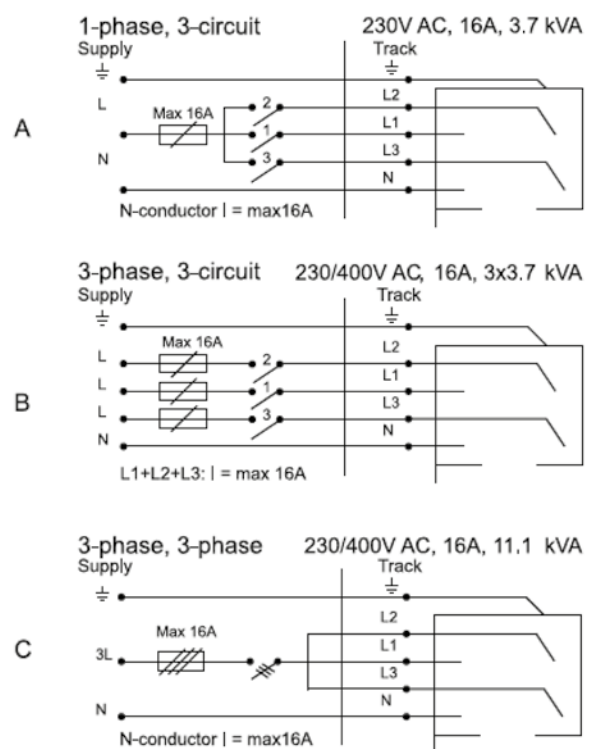

GLOBAL Trac Base

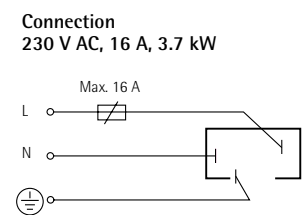

The market leader and pioneer lighting tracks

Nordic Aluminium designs, manufactures and markets lighting tracks and accessories related. The company has long history and expertise in aluminium production. The market leadership is the result of over 45 years of experience and determined investment in design and R&D.

Effective and precise customer service is the operational basis of Nordic Aluminium. Successful business lays its foundation on long-term partnerships in which close cooperation with clients is of key importance in each stage of the service chain. High quality standards and innovative utilization of the unique characteristics of aluminium are essential operational principles of Nordic Aluminium – be it the initial design of a product, production or refinement. That is why the company's motto is "Quality in Focus".

GLOBAL Trac is a registered trademark of Nordic Aluminium.

MULTI Adapter™ and FIX Point™ are trademarks of Nordic Aluminium.



The quality management system that Nordic Aluminium Plc use is approved by Bureau Veritas Certification and conforms with the ISO 9001:2008 standard.



The environment management system that Nordic Aluminium Plc use is approved by Bureau Veritas Certification and conforms with the ISO 14001:2004 standard.

NORDIC  ALUMINIUM

Nordic Aluminium
P.O. Box 31, FI-04131 Sipoo, Finland
Visiting address: Kaapelitie 68, FI-02490 Pikkala, Finland
Tel. +358 20 7660 200, fax +358 20 7660 485, www.nordicaluminium.fi