

Installationsanvisning
Assembly instruction
Asennusohje

Ettålsventil
One hole connected valve
1-putkiventtiili

RFA 38

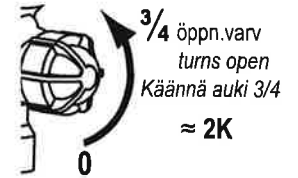
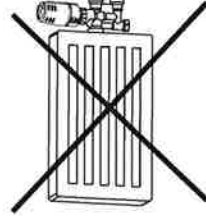
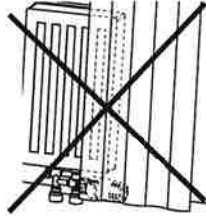
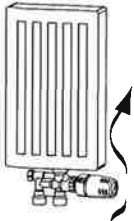

Monteras ej i VVC-system. Not in potable water system. Ei saa asentaa käyttövesijärjestelmään.

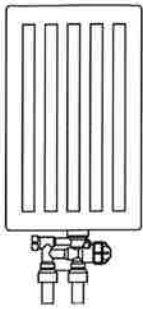

Levererad som 2-rörsventil.
Delivered as 2-pipe valve.
Toimitettu kaksisuuntaventtiilinä.

Ventilförinställning, se sid.2
Valve pre-setting, see page 2
Venttiilin esisäätö, katso s. 2..

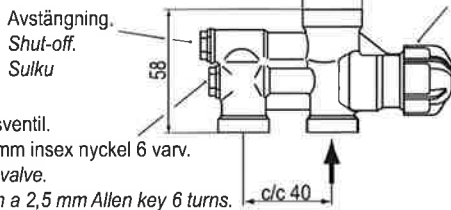

Omställning 1-2 rörsventil.
Öppna med en 2,5 mm insex nyckel 6 varv.
Adjustable 1-2 pipe valve.
For 1-pipe open with a 2,5 mm Allen key 6 turns.
Säddettäv 1-2-suuntaventtiili. 1-suuntaventtiili
avataan 2.5 mm Allen-avaimella 6 kierrosta.

Montering
Assembly
Asennus

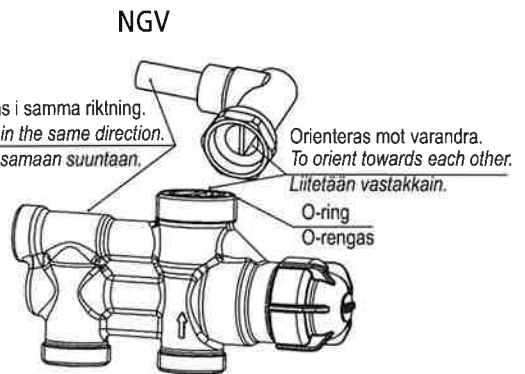
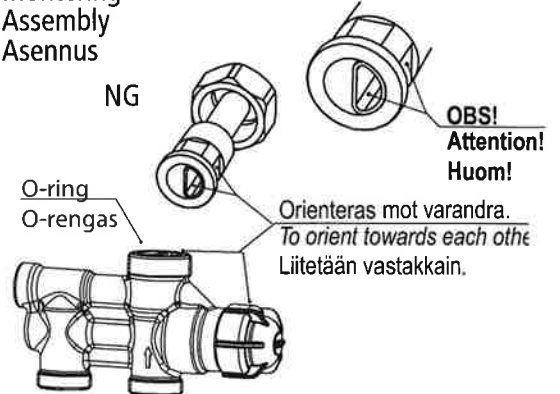

Typ Type Tyyppi	Anslutning mot rörsidan Connection to pipe system Liitäntä putkistoon	Anslutning med NG/NGV mot radiatorn Connection with NG/NGV to radiator NG/NGV-liitäntä patteriin
RFA 38	M22x1.5	ISO-R 1/2

1-rörssystem
1-pipe system
1-putkiventtiili

Kv_{2K}

(Ventilförinställning fullt öppen)
(Valve pre-setting fully open)
(Venttiilin esisäätö täysin auki)

öppn.varv X turns open X Bypass Avatut kierrokset	Kv total yht.	Kv radiator patteri	% radiator patteri
0,5	0,78	0,7	90
1	0,82	0,66	81
1,5	0,85	0,65	73
2	1,05	0,63	64
2,5	1,12	0,62	55
3	1,28	0,61	45
3,5	1,42	0,57	40
4	1,60	0,53	33
4,5	1,78	0,48	27
5	1,88	0,43	22

Kv_S

(Ventilförinställning fullt öppen)
(Valve pre-setting fully open)
(Venttiilin esisäätö täysin auki)

öppn.varv X turns open X Bypass Avatut kierrokset	Kv total yht.	Kv radiator patteri	% radiator patteri
0,5	0,84	0,77	91
1	0,89	0,76	85
1,5	0,95	0,74	77
2	1,02	0,70	69
2,5	1,12	0,68	61
3	1,23	0,64	51
3,5	1,34	0,60	45
4	1,49	0,57	38
4,5	1,65	0,52	32
5	1,80	0,48	27

Inställning bypass
Bypass setting
Ohitusventtiilin asetukset

1. Ta bort den blå plastpluggen.
Remove the blue plastic plug.
Irrota sininen muovitulppa.

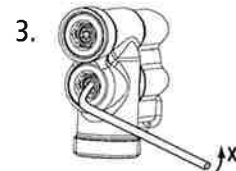
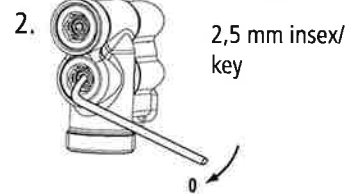

Ventilföreställning
 Valve pre-setting
 Venttiilin esisäätö

2-rörssystem
 2-pipe system
 2-putkiventtiili

RFA 38

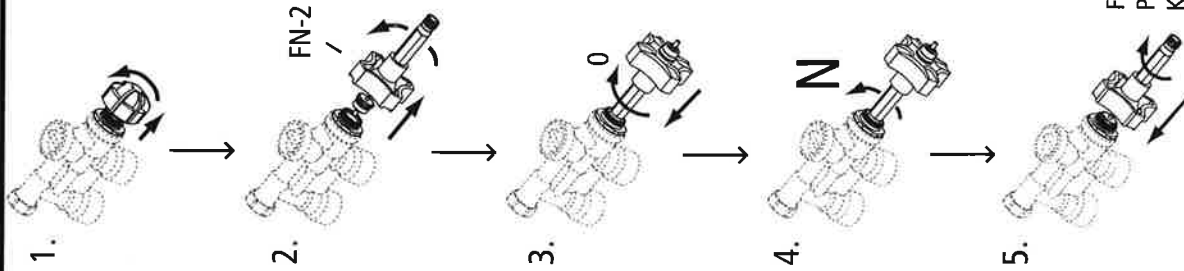

Levererad i detta utförande som 2-rörventil.
 Omställning 1-rörs öppna med en 2,5 mm insex
 nyckel 6 varv.
 Delivered like this as 2-pipe valve. For 1-pipe open
 with a 2,5 mm Allen key 6 turns.
 Toimitettu kuvan mukaisena kaksisuuntaventtiilinä.

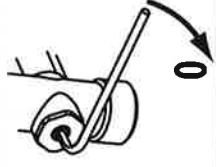

Öppn.varv
 Opening turns
 Avatut kierrokset

N

gäller för:
 valid for:
 koskee tuotetta:

KVs

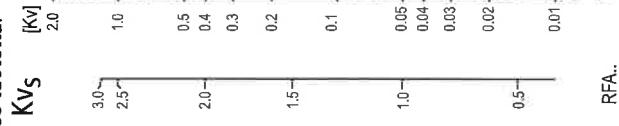

Öppn.varv
 Opening turns
 Avatut kierrokset

N

gäller för:
 valid for:
 koskee tuotetta:

KV2K

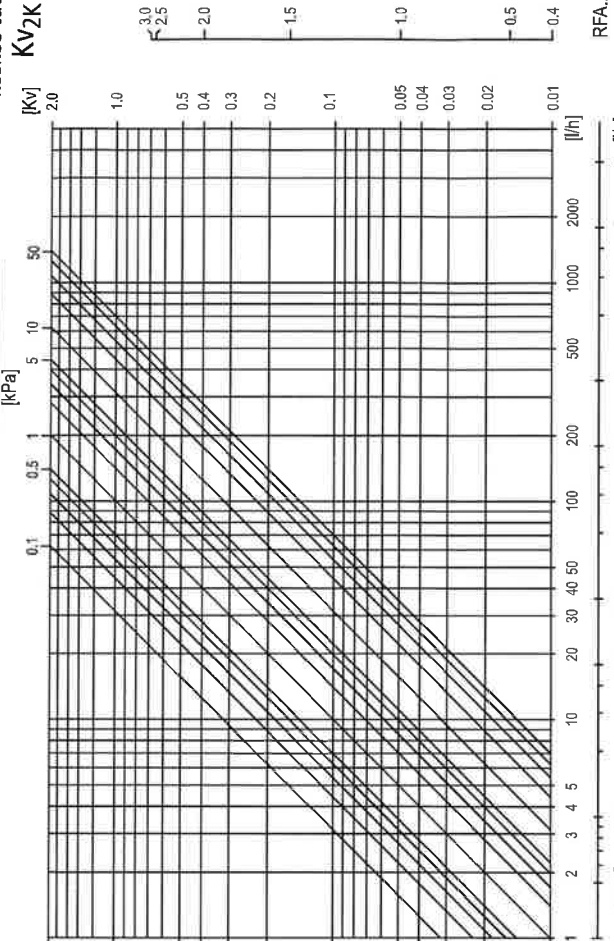

Föreställning av 2-rörssystem kan även göras m.h.a. FV 5.
 Pre-setting 2-pipe system will be made with pre-setting tool FV5.
 Kaksisuuntaventtiilin esisäädön voi tehdä myös FV 5:n avulla.