

Instruction manual

Jet Tower

Indoor use only

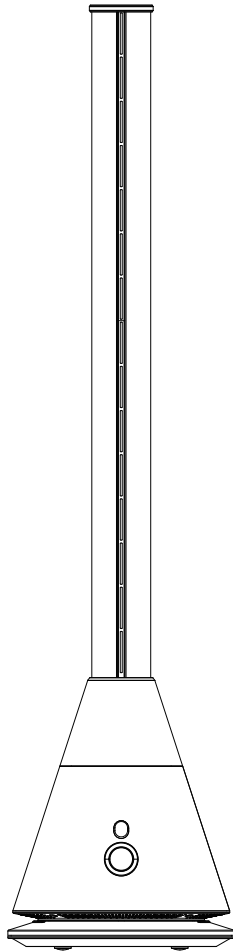

ATTENTION

To ensure you are satisfied with the product and properly clean and maintain it, please read the instruction manual carefully before use. Also, please take good care of this manual for future reference.

	DANGER If the dangerous situation is not avoided, this can lead to death or serious injuries.
	ATTENTION If the dangerous situation is not avoided, this can lead to serious injuries.

	Symbol indicates "prohibited"
	Symbol indicates "force" (please be sure)

■ General Safety information

- ① Examine the device for any visible external damages prior to using it. Never put a damaged device into operation
- ② Persons, who are not able to operate the device because of any physical, mental may only use the device under the supervision or under the instructions of a responsible person.
- ③ Do not permit children to use the device, unless they are supervised.
- ④ Only qualified electricians, who have been trained by the manufacturer, may carry out any repairs that may be needed. Improperly performed repairs can cause considerable dangers for the user.

DANGER	
 Prohibit	Only qualified electricians, who have been trained by the manufacturer, may carry out any repairs that may be needed.
 Prohibit	<p>This appliance is used in the household only</p> <p>Please use a separate outlet in accordance with the appliance current/voltage. Don't use more than one electrical appliance at the same time on the same outlet.</p> <p>Do not pull the connecting cable to remove the plug from the mains socket.</p> <p>Do not use the appliance if the mains cable or mains plug is damaged.</p> <p>Do not open the housing of the appliance</p> <p>Danger from electric current if live connections are touched and/or the electrical and mechanical configuration is changed.</p> <p>Never immerse the appliance or the mains cable into water or other liquids.</p> <p>Do not touch the connecting cable with wet hands when disconnecting the appliance from the mains supply.</p>
 Prohibit	<p>This appliance may be used by children under the age 8 years and by persons with decreased physical, sensory or mental abilities or lack of experience and/or knowledge only if they are supervised or were instructed on using the appliance and have understood the resulting dangers.</p> <p>Cleaning or user-maintenance may not be performed by children who are not under supervision. Children must be supervised to ensure that they do not play with the appliance.</p> <p>Store the appliance and accessory parts out of the reach of children.</p> <p>Fire risk</p> <ul style="list-style-type: none"> ▶▶ Never cover the appliance when it is in operation. ▶▶ Do not put the appliance in the vicinity of easily inflammable materials such paint, varnish or gas. ▶▶ Allow a gap of at least 1 metre between the fan and all flammable and heat-sensitive materials (furniture, curtains, paper, clothes etc.).



WARNING



CAUTION

Immediately disconnect the power plug from the electrical outlet and stop using it when find (abnormal noise • burnt odor etc.).

If you continue to use it remains abnormal, there is a risk that leads to smoke or fire, electric shock or injury.

Please consult your dealer

During use, when the power plug or power cord becomes abnormally hot, it is with risk of fire. please stop using.



CAUTION

Please clean plug regularly in dry cloth, it will be the cause of the fire if it is dirt and dust that it will become defective insulation.



CAUTION



Prohibit

- Place the appliance on a firm, dry, flat and waterproof surface.
- Do not install the appliance in a hot, wet or very humid environment.
- Never place the appliance or parts of the appliance in the vicinity of strong heat sources and hot surfaces (e.g., heating, oven, grill).
- Do not place the appliance in a confined, in an alcove, corner or constricted between items of furniture. Allow sufficient space around it so that the air can circulate.



Prohibit

- The appliance becomes very hot during operation. Therefore, do not touch the hot surfaces of the appliance during operation and for a short time afterwards.
- Wait until the appliance has cooled down before transporting it.
- Do not spray air freshener into the airflow.
- Do not place the appliance in front of an automatic air freshener atomizer system.



CAUTION

- Always switch off the appliance at the control panel and wait for it to run down before switching the main ON/OFF switch and pulling the plug out.
- Do not put objects into the openings or ventilation grilles.
- Keep the appliance free from dust, fluff, hair and above all, anything that could restrict the airflow.

CAUTION

Caution for parent

Children and infant must be supervised to ensure that they do not play with the appliance.

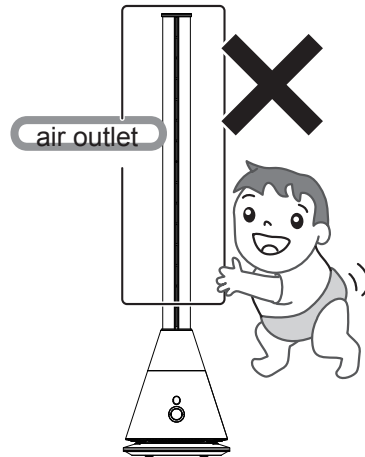

Cleaning of air inlet

Check the air inlets and the air slot for free flow.
Eliminate contamination such as dirt or dust particles with a soft brush.

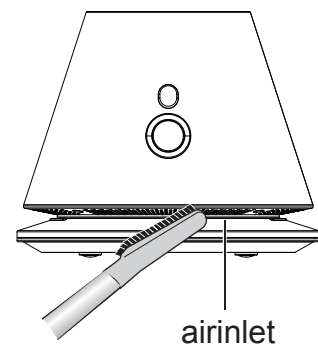

Part list

front side

back side

remote control

※ please refer page 6 for remote control operation

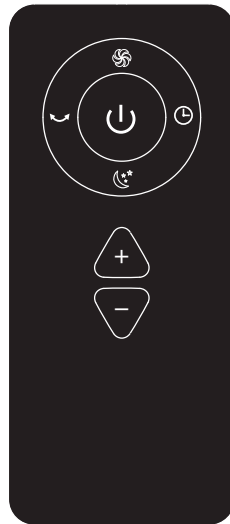

■ CR2025 button cell

※ please refer page 5 for button assemble



air outlet

LED display

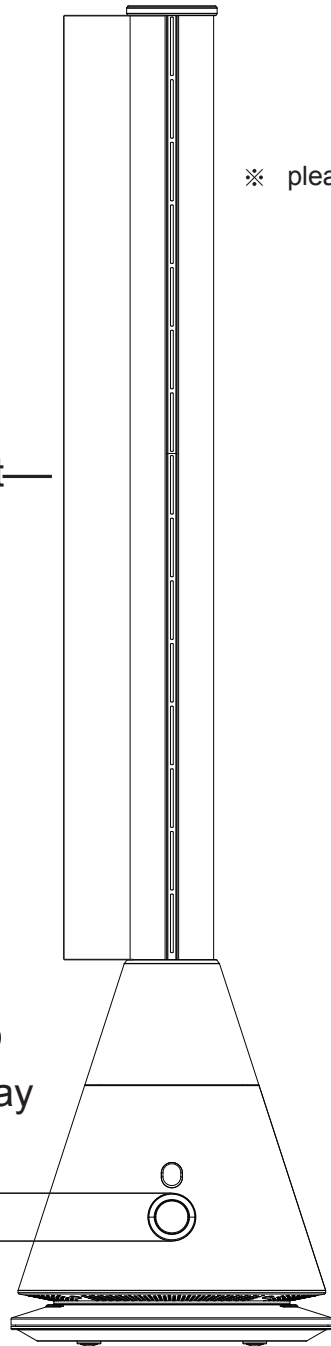

airinlet

power plug

power cord

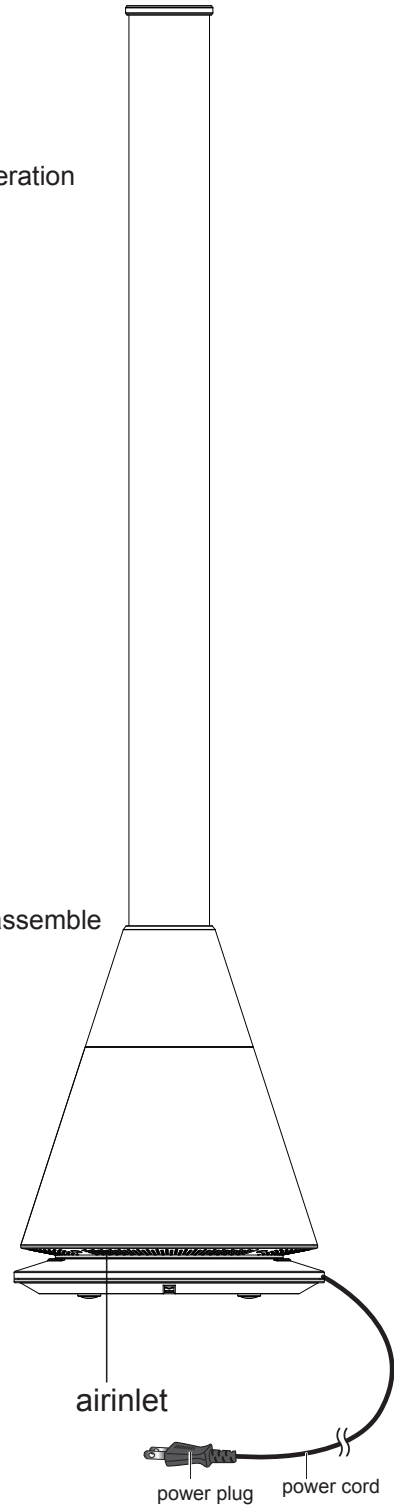

Before first use

using place

- The fan shall be put in a leveled place
Please don't place the fan in unstable places, such as slope, soft surface to avoid the fan to be damaged or malfunction due to overturned
- keep curtains away from the sides and rear when the fan is plugged in
Don't put any object into the inlet grille.
- Don't place objects within 30 cm in front of the outlet

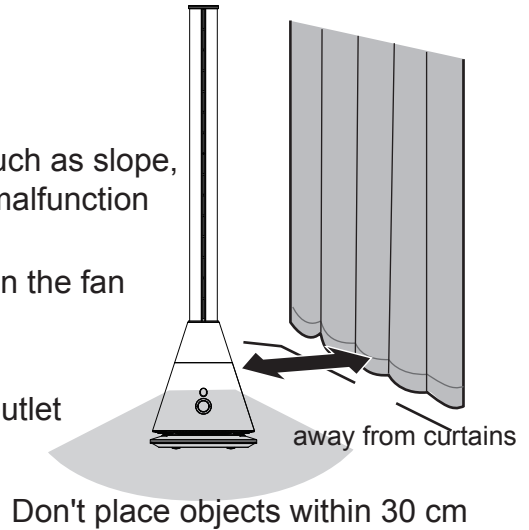

Battery replacement

button cell replacement

- please prepare button cell [CR2025]
- 1 as shown to press the battery cover
take out battery compartment

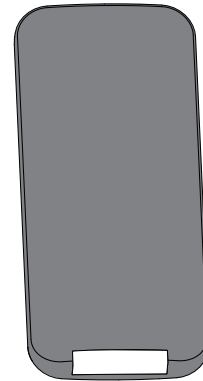

- 2 insert a new battery with + mark
facing upwards

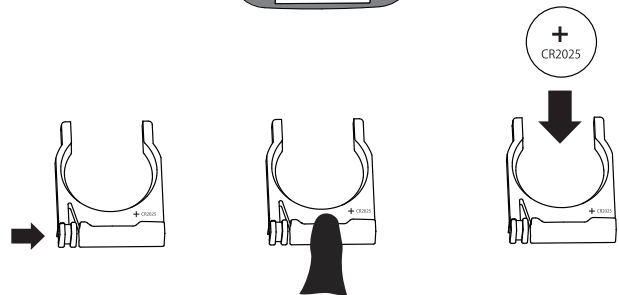

- 3 insert the battery compartment into
the remote control

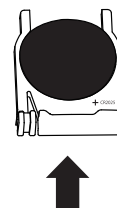

 please take out battery if is not used for a long time

Operation function

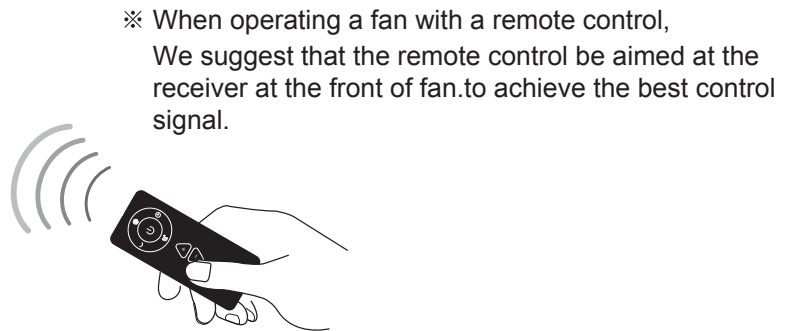
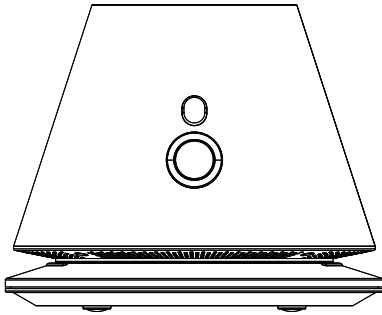

The following case may occur when operation the fan

1. This fan may work when using remote control of other electrical appliances.
2. others appliances may work when using remote control of this fan

This is due to the overlap of the frequency of the remote control. It is not the quality problem. please away from others appliances when use this remote control

- ① insert the power plug into the socket and LED display will be switch on.

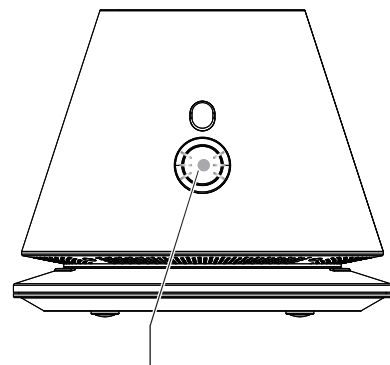
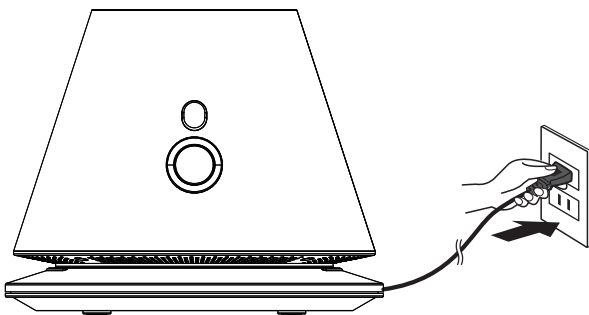

LED display

REMOTEL CONTROL (RC)

- All function can be operated by RC

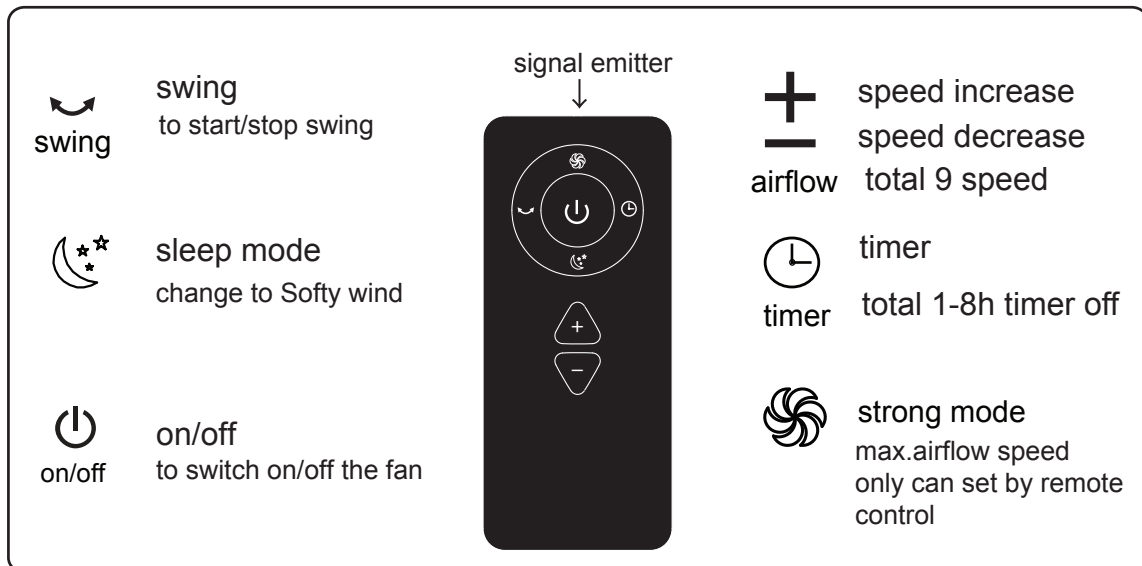

Operation instruction

You can hear Beep when you operate the fan or RC

■ TURN ON/TURN OFF

FAN  the fan will start to blow air when touch the LED display long press 4 second and remove the hand after hear 2nd beep voice the fan will stop working

RC  the fan also can be turn on/off operate by remote control.
turn on/off

■ timer control

RC  Press this button to set timer off 1 to 8 hour
timer

- ※ The other functions of the fan still can be used after the timer function is set
- ※ After the fan power is turn off, the timer setting will also be cancelled
- ※ The machine will stop running after the time you set. please press the power button again If you need to restart,.

■ Sleeping model

RC



sleep wind

Please press this button on the remote control that LED display will appear L,
The wind turns to be soft.

Press again to exit sleep mode.

Press wind speed button + - also can exit this mode

■ Strong wind

RC



strong wind

Please press this button on the remote control that LED display will appear H,
The wind turns to be strong.

Press again to exit strong mode.

Press wind speed button + - also can exit this mode

■ SWING FUNCTION

FAN

long press 2 second to start swing.

long press 2 second again and remove the hand after hear 1st beep voice
the swing will be stopped

RC



swing

swing function also can be operated by remote control.

Attention

- It not means power off if you just turn off the power button on the fan either or the remote control .Please pull the plug out if it won't use for a long time.



cleaning and maintenance

- switch off the fan and unplug it from the wall outlet

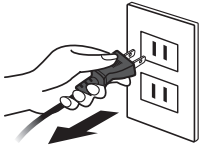

Don't splash water on the fan, It could be damaged.

Please don't use banana oil, gasoline, alcohol, bleach or metal object to clean surface of the fan

fan surface

- Please gently wipe the surface with a clean soft cloth
you can use a mild detergent after diluted with wet cloth to wipe the fan surface, then wipe with a soft dry cloth. If the fan surface is dirty

Air inlet ,air outlet

- use a soft brush to clean the opening around the air outlet, alternatively, lightly run a vacuum cleaner nozzle (soft brush) over the air outlet to remove any debris that may have accumulated inside.

REMOTE CONTROL

- Wipe the remote control surface gently with a dry, soft cloth.
remove the battery inside of remote control if it is not used for a long time,

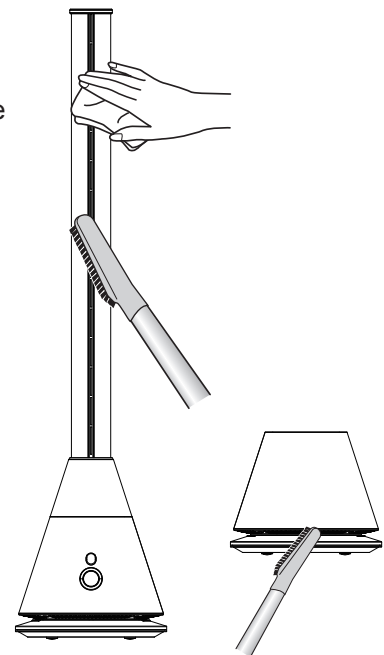

PLUG

- Please clean the power plug with a dry soft cloth



Storage

- place in a large plastic bag for dust protection
- Please avoid to put in the shaking places and nearby electrical appliances with refrigeration/heating function
- please store the fan in the clean and dry place
- Please place it where children can't touch it.

warranty return

- When abnormal situation occurs, please check the follows first.
please consult with the shop you purchased from if still has problems.

 Danger

Please don't disassemble and repair the fan

problem	possible cause and solution
Plug it in but don't work	<ul style="list-style-type: none"> ● the plug is inserted correctly? → Is the power indicator on?
RC don't work	<ul style="list-style-type: none"> ● Is the battery no power? → Please replace the battery(refer page 5) ● Is the battery installed in the right direction? → Please change the battery direction(refer page 5) ● Is the remote control aim at the signal receiver of fan? → please refer page 6

specifications

RATED VOLTAGE : 220V~	weight :
Frequency : 50Hz	power cord length : 150cm
Rated power : 26W	
swing range : 80°	
timer range : 1-8 hour	
product meas. : 23X23X96CM	
material : ABS、POM	
spare part : remote control、battery、manual、	

