

Thermex Jet Ball

INSTRUCTION MANUAL

*Read all instructions carefully before using the FAN, and keep this instruction for future reference when necessary

Important Safety Information

- Read all instructions carefully before using the Fan.
- Use this Fan only as described in this manual. Any other use not recommended by the manufacturer may cause fire, electrical shock or injury to persons.
- Open the package and ensure that the Fan is undamaged. In case of doubt do not use the FAN Cooler and contact your supplier.
- Do not let children play parts of package.
- Before using the Fan, check if the voltage marked on the rating label corresponds to the mains at your home.
- This appliance is not intended for use by persons (including children) with reduced physical, sensory or mental capabilities, or lack of experience and knowledge, unless they have been given supervision or instruction concerning use of the appliance by a person responsible for their safety. Children should be supervised to ensure that they do not play with the appliance.
- Avoid using extension cord as it may overheat and cause fire.
- Do not pull the power cord to disconnect from power source. Always grasp the plug to pull out.

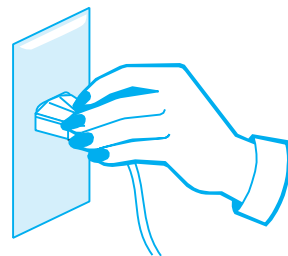
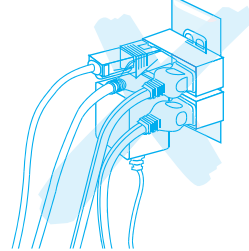
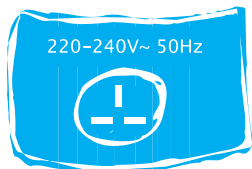

Important Safety Information

- Do not insert any objects into the Fan as it may cause an electric shock or damage. Do not block or tamper with the Fan in any manner while it is in operation.
- Do not leave the Fan unattended. Always unplug the Fan Cooler when not in use.
- **WARNING:** The On/Off switch should not be used as the sole means of disconnecting power. Always unplug the power cord before servicing or moving the unit.
- This Fan is intended for household use **ONLY** and not for industrial or outdoor use.
- Always disconnected the Fan from the power supply when moving it from one location to another.
-  This product contains recyclable materials. Do not dispose this product as unsorted municipal waste. Please contact your local municipality for the nearest collection
- The Fan is not intended for use in wet or damp locations. Never locate the Fan where it may fall into a bathtub or other water container.
- Do not place the Fan near a source of heat or fire.
- Keep the Fan clean to maintain in good condition (refer to maintenance section).
- **WARNING:** To avoid danger of electric shock, unplug from outlet when not in use and before cleaning. If the power cord is damaged, it must be replaced by the manufacturer, its service agent or similarly qualified persons in order to avoid hazard.



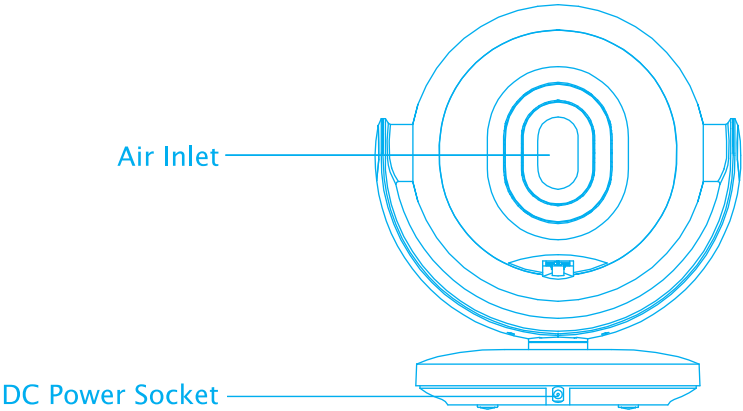
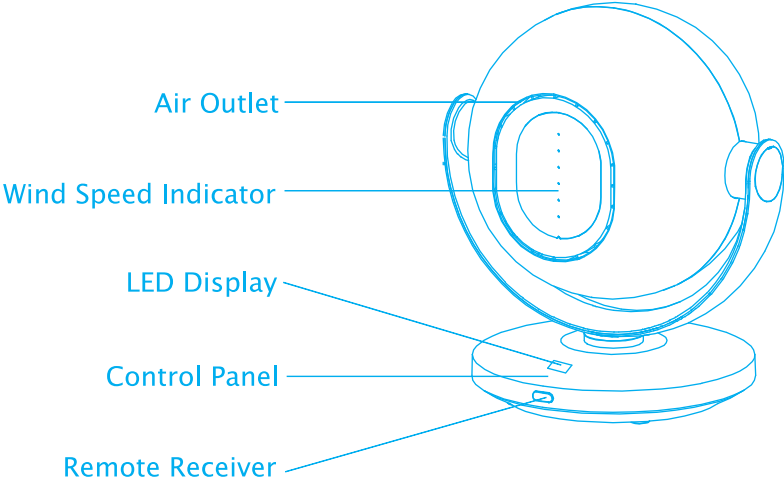

The Fan may be operated by the control panel (as shown in Figure 1) or by your remote control.

1. Place the Fan on a stable and flat surface. Plug the DC power jack of AC/DC adaptor to the DC power socket and turn 90 degree. Then plug the power cord into an a.c. 220–240V electrical outlet. The LED screen will display "00".
2. POWER: Turn the Fan ON by pressing the  key, the Fan start at speed level 3.

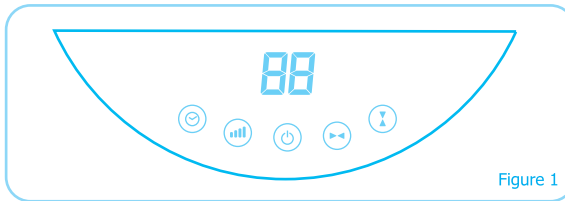







Figure 1

3. SPEED: Press the  key to adjust the Fan speed to desired level (1 to 6 level). The speed setting is displayed on the LED light.
4. OSC(UP/DOWN): Press the  key to allow the Fan to UP/DOWN oscillate the wind direction. To stop the oscillation, press the key again.
5. OSC(LEFT/RIGHT): Press the  key to allow the Fan to LEFT/RIGHT oscillate the wind direction. To stop the oscillation, press the key again.
6. TIMER: Press the  key to set desired auto power off time, There are 8 time intervals, from 1 to 8 hour.
7. SLEEP MODE (For remote control only): Press the  key to sleep mode, fan speed will drop down 1 level every half hour from the original setting level to the lowest level.

*** Remarks: After settings, the LED light and display will light off automatically after 10 to 20 seconds.

Remote Control

Battery replacement: Install one 3V Lithium battery

WARNING

- 1) Keep batteries out of reach of children. Should a child swallow a battery, consult a doctor immediately.
- 2) Do not recharge or dispose in fire.
- 3) Keep in a dry and cool place
- 4) Insert battery in right direction.



Battery Disposal – please dispose the used battery per municipal or provincial law.

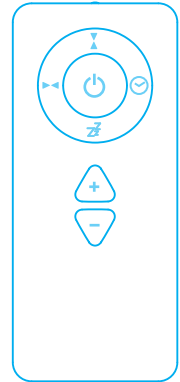
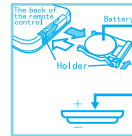

Maintenance

WARNING: ALWAYS UNPLUG THE POWER CORD BEFORE MOVING OR SERVICING. DO NOT IMMERSE THE FAN IN WATER! BEFORE CLEANING, MAKE SURE THAT THE UNIT HAS BEEN SWITCHED OFF AND IT IS UNPLUGGED FROM THE MAIN OUTLET.

Housing : Clean the outside of the Fan with a soft cloth. To remove persistent dirt, wipe down with a cloth that has been dampened with warm soapy water.

Air Filter Net: Unclick the buckle of the air filter net cover and pull the air filter net out. Wash the net with a soft water or soft damp cloth, and then place back to the fan after drying.

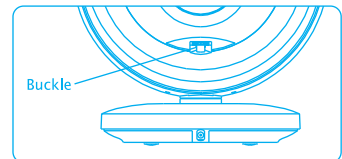

CAUTION: Do NOT use gasoline, benzene, thinner, harsh cleaners, etc., as they will damage the Fan. NEVER use ALCOHOL or any other SOLVENTS.

STORAGE: Store the Fan with these instructions in the original box in a cool and dry place.

Specification

Model Number	260.21.1000.2
Power Supply	220-240V~50Hz / DC 24V
Rated Power	26W
Package Dimension	358 x 285 x 382 mm

