

550B1013



WiFer™



Forudsætninger

Download Wisier app'en til din smartphone / tablet, og installer Wisier Gateway for at konfigurere og styre dine Wisier enheder.

Yderligere information

Detaljeret produktinformation er tilgængelig online i **systemvejledningen**: Scan QR-koden eller følg linket.

<https://www1.lk.dk/wiser>

For din sikkerhed

▲ ▲ FARE

FARE FOR ELEKTRISK STØD, EKSPLOSION ELLER LYSBUE

Sikker elektrisk installation må kun udføres af kvalificerede fagfolk. Dygtige fagfolk skal have dybtgående viden på følgende områder:

- Tilslutning til fast installation
- Tilslutning af flere elektriske enheder
- Lægning af elektriske kabler
- Sikkerhedsstandarder, lokale regler og forskrifter

Manglende overholdelse af disse instruktioner kan resultere i død eller alvorlig personskade.

Lær produktet at kende

Wisier trådløs jalusi for indbygning (puck) (i det følgende benævnt **puck**) bruges til at styre en persienne- og jalusimotor udstyret med en slutpositionskontakt.

i Relækontakter, der er mekanisk låst mod hinanden, forhindrer samtidig aktivering af de to relæudgange.

Puck'en må ikke bruges til at kontrollere sikkerhedsrelaterede applikationer.

Styringsmuligheder

Boligstyring: For at styre puck'en i dit hjem gennem Wisier app'en skal du bruge Wisier Gateway.

Rumstyring: For at styre puck'en gennem andre Wisier enheder skal enhederne parres. Wisier enhederne skal være på det samme Zigbee-netværk.

Direkte styring: Puck'en kan styres med dobbeltrykknapper direkte tilsluttet puck'en. Du kan tilslutte maksimalt 10 mekaniske dobbeltrykknapper.

Funktioner:

- Mekanisk og elektronisk låsning
- Indstilling af en timer eller en tidsplan (via app)
- Indstilling af køretid (via app)

Valg af installationssted

Hvis du placerer puck'en bag et mekanisk tryk skal du sikre dig at der er plads til hele installationen i dåsen eller underlaget.

Terminaler

- (A) Motor tilslutning (op/ ned)
- (B) 230 V a.c.
- (C) 0 V
- (D) Eksterne kontakter 1
- (E) Eksterne kontakter 2

Installation af puck'en

Forbindelse af puck'en

▲ ▲ FARE

FARE FOR ELEKTRISK STØD

- Sørg for, at terminalforbindelsesområdet ikke kommer i kontakt med de metaliske dele på en enhed, der er installeret på samme sted.
- Kortslut ikke output til 0 V.
- Motorkontakterne og strømførende forbindelsen skal adskilles fra hinanden med en 240 V a.c. isolering.
- Når du arbejder på enheden, skal du altid afbryde enheden fra strømforsyningen, da udgangen kan have elektrisk strøm, selv når belastningen er slukket.
- Sluk sikringen i det indkommende kredsløb inden installation, vedligeholdelse eller service (eller udskiftning af belastningen) på enheden.

Manglende overholdelse af disse instruktioner kan resultere i død eller alvorlig personskade.

Betjeningslementer

- (F) Status lysdiode
- (G) Setup/reset knap
- (H) Test knap

Indstilling af puck'en

▲ ADVARSEL

FARE FARE FOR ELEKTRISK STØD

- Overhold reglerne for arbejde på udstyr under spænding.
- Aktiver kun enhedens knappe ved hjælp af isoleret hjælpedstyr, der opfylder kravene i EN 60900

Manglende overholdelse af disse instruktioner kan føre til død eller alvorlig personskade.

Test af puck'en

Før du forbinder puck'en eller tilslutter mekaniske trykknapper, kan du teste de grundlæggende funktioner.

Forbindelse til Wisier Gateway

Tryk 3 gange kortvarigt (<0,5 s) på knappen setup/reset for at oprette forbindelse til et tilgængeligt Zigbee-netværk. Efter en vellykket forbindelse til Wisier Gateway lyser status lysdioden grønt.

Parring med andre Wisier enheder

For at styre puck'en i rumstyringstilstand kan den parres med andre Wisier enheder i det samme Zigbee-netværk.

For yderligere oplysninger, se systemvejledning.

Nulstilling af puck'en

Tryk 3 gange kortvarigt (<0,5 s) på setup/reset-knappen, og tryk derefter en gang i lang tid på Setup / Reset-knappen mellem 10-15 s for at nulstille puck'en til fabriksstilstand.

Alle konfigurationsdata, brugerdata og netværksdata slettes, efter hvilket gælder:

- Ingen forbindelse til andre enheder eller værelser
- Ingen timerindstillinger

Betjening af puck'en

Du kan fjernstyre puck'en via Wisier app'en.

Betydning af status lysdiode

Se systemvejledning.

Fejlfinding

Se systemvejledning.

Tekniske data

Mærkespænding	220-240 V a.c., 50/60 Hz
Mærkestrøm	4 A, cosφ = 0,6 - 1,0
Udgangskanal	1, mekanisk og elektronisk låst mod hinanden.
Standby	Maks. 0,3 W
Driftstemperatur	0 °C til 35 °C
Nul-leder	Påkrævet
Terminaler	Maks. 2 x 2,5 mm ² , stiv eller flettet leder
Eksterne betjeningstryk	Maks. 10 mekaniske trykknapper
Længde af kabler	Maks. 50 m for 3-leder NYM Kabel
Forsikring	16 A
Kapslingsklasse	IP20
Frekvensområde	2,4 GHz
Maks. Transmitteret effekt	<2,5 mW
Dimensioner (H x B x D)	43 x 43 x 22 mm
Dybde af dåse- eller underlag	Skal minimum være 26 mm dyb.
EU deklaration	1003662-0
Certifikater	Zigbee 3.0

Bortskaf enheden separat fra husholdningsaffald på et officielt opsamlingssted. Professionel genanvendelse beskytter mennesker og miljøet mod potentielle negative effekter.

Varemærker

- Zigbee® er et registreret varemærke tilhørende Zigbee Alliance.
- Apple® og App Store® er mærkenavne eller registrerede varemærker tilhørende Apple Inc.
- Google Play™ Store og Android™ er mærkenavne eller registrerede varemærker tilhørende Google Inc.

Andre mærker og registrerede varemærker tilhører deres relevante ejere.

EU-overensstemmelseserklæring

Schneider Electric Danmark A/S erklærer hermed, at dette produkt er i overensstemmelse med de væsentlige krav og andre relevante bestemmelser i RADIO EQUIPMENT DIRECTIVE 2014/53 / EU. Overensstemmelseserklæringen kan downloades på adressen se.com/docs.

Lauritz Knudsen

Schneider Electric Danmark A/S, Lautrupvang 1, 2750 Ballerup, Telefon: +45 88 30 20 00, www.lk.dk



4 A, cosφ = 0.6 - 1.0

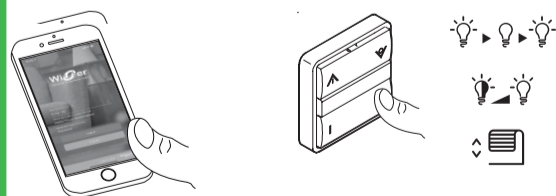
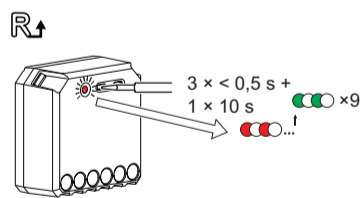
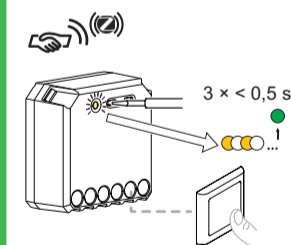
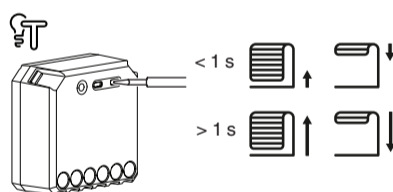
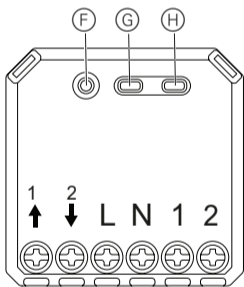
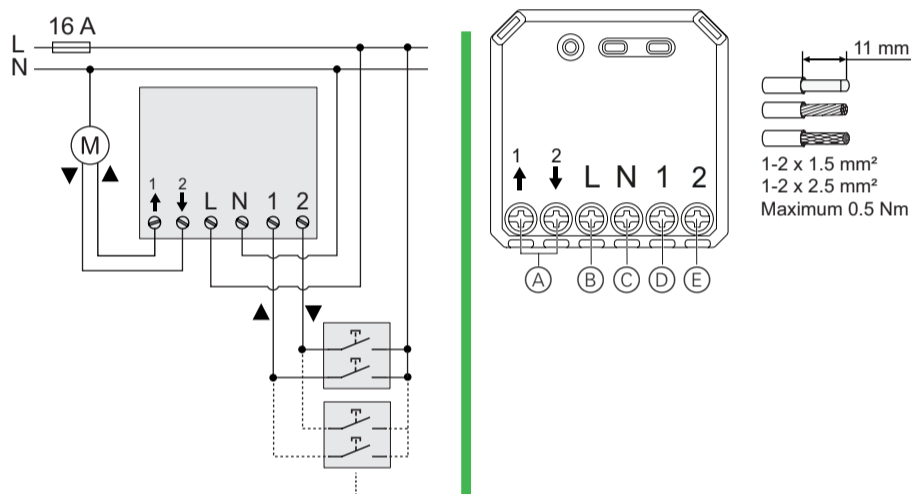
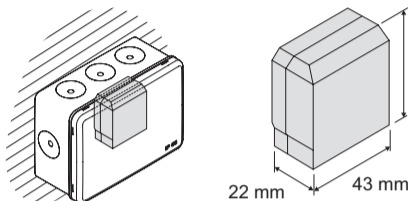

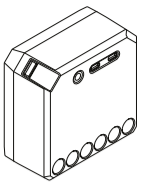

550B1013

Wiser

**Wiser wireless shutter control for build in (Puck)****Prerequisites**

Download the **Wiser app** to your smartphone / tablet, and install the **Wiser Gateway** to configure and control Wiser Smart devices.

Additional system information

Detailed product information is available online in the **system user guide**: Scan the QR code or follow the link.

<https://www1.lk.dk/wiser>**For your safety****⚠ ⚠ DANGER****HAZARD OF ELECTRIC SHOCK, EXPLOSION, OR ARC FLASH**

Safe electrical installation must be carried out only by skilled professionals. Skilled professionals must prove profound knowledge in the following areas:

- Connecting to installation networks
- Connecting several electrical devices
- Laying electric cables
- Safety standards, local wiring rules and regulations

Failure to follow these instructions will result in death or serious injury.

Getting to know the product

The Wiser wireless shutter for build in (Puck) (hereinafter referred to as **puck**) is used to control one shutter/blind motor equipped with an end position switch.

i Relay contacts mechanically locked against each other prevent simultaneous triggering of the two relay outputs.

i The puck must not be used to control safety relevant applications.

Control options

Home control: To control the puck in your home through the Wiser app, you will need the Wiser Gateway.

Room control: To control the puck through other Wiser devices, it can be paired. Wiser devices has to be in the same Zigbee network.

Direct operation: The puck can always be controlled directly on-site. To do this, you can connect a maximum of 10 mechanical double push-buttons.

Functions:

- Mechanical and electronic locking
- Setting a timer or a time schedule (via app)
- Setting the running time (via app)

Choosing the installation location

If you place the puck behind a mechanical push-button, use a deep installation box.

Connection elements

- (A) Motor contacts (up/down)
- (B) Live conductor
- (C) Neutral conductor
- (D) Extension unit input 1
- (E) Extension unit input 2

Mounting the puck**Connecting the puck****⚠ ⚠ DANGER****HAZARD OF ELECTRIC SHOCK**

- Make sure that the terminal connection area does not come in contact with the metallic parts of any device installed in the same location.
- Do not short the outputs to neutral.
- The motor contacts and live conductor connection must be separated from one another by a 240 VAC basic insulation.
- When working on the device, always disconnect the device from the power supply, as the output may carry electrical current even when the load is switched off.
- Turn off the fuse in the incoming circuit before installation, maintenance, or service (or replacement of the load) of the device.

Failure to follow these instructions will result in death or serious injury.

Operating elements

- (F) Status LED
- (G) Setup/Reset button
- (H) Test button

Setting the puck**⚠ WARNING****DANGER DUE TO ELECTRIC SHOCK**

- Observe the regulations for working on live parts.
- Only actuate the device buttons using insulated auxiliary equipment that meets the requirements of EN 60900

Failure to observe these instructions can lead to death or serious injury.

Testing the puck

Before you couple the puck or connect mechanical push-buttons, you can test the basic functions.

Connecting to the Wiser Gateway

Short press (< 0,5 s) the Setup/Reset button 3 times to connect to the available Zigbee network. Upon successful connection to the Wiser Gateway the status LED turns green.

Pairing to other Wiser devices

To control the product in a room control mode, it can be paired with other Wiser devices within the same Zigbee network.

For more details, refer to the system user guide.

Resetting the puck

Short press (< 0,5 s) the Setup/Reset button 3 times and then long press the Setup/Reset button once for >10 s and <15 s to reset the puck to factory default mode.

All configuration data, user data, and network data is deleted. After which:

- No connectivity to other devices or rooms
- No timer settings

Operating the puck

You can remotely control the puck through the Wiser App.

Behaviour of the status LED

Refer to the system user guide.

Troubleshooting

Refer to the system user guide.

Technical data

Nominal voltage	AC 220-240 V, 50/60 Hz
Nominal current	4 A, cosφ = 0.6 - 1.0
Blind channel	1, mechanically and electronically locked against each other
Standby	Maximum 0.3 W
Operating Temperature	0 °C to 35 °C
Neutral conductor	Required
Connecting terminals	Maximum 2 x 2.5 mm ² , solid or stranded types
Extension connection	Maximum 10 mechanical push-buttons
Length of all cable sections	Maximum 50 m for 3-wire NYM Cable
Fuse protection	16 A circuit breaker
IP rating	IP20
Operating frequency	2.4 GHz
Max. radio-frequency power transmitted	<2.5 mW
Product dimensions (H x W x D)	43 x 43 x 22 mm
Wall box dimension	i The wall box must have a minimum depth of 26 mm.
EU declaration	1003662-0
Certification	Zigbee 3.0

Dispose of the device separately from household waste at an official collection point. Professional recycling protects people and the environment against potential negative effects.

Trademarks

- Zigbee® is a registered trademark of the Zigbee Alliance.
- Apple® and App Store® are brand names or registered trademarks of Apple Inc.
- Google Play™ Store and Android™ are brand names or registered trademarks of Google Inc.

Other brands and registered trademarks are properties of their relevant owners.

EU Declaration of conformity

Hereby, Schneider Electric Danmark A/S, declares that this product is in compliance with the essential requirements and other relevant provisions of RADIO EQUIPMENT DIRECTIVE 2014/53/EU. Declaration of conformity can be downloaded on: se.com/docs.

Lauritz Knudsen

Schneider Electric Danmark A/S, Lautrupvang 1, 2750 Ballerup, Phone: +45 88 30 20 00, www.lk.dk



4 A, cosφ = 0.6 - 1.0

