

550D6001

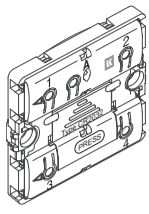

550D0001



WiFer

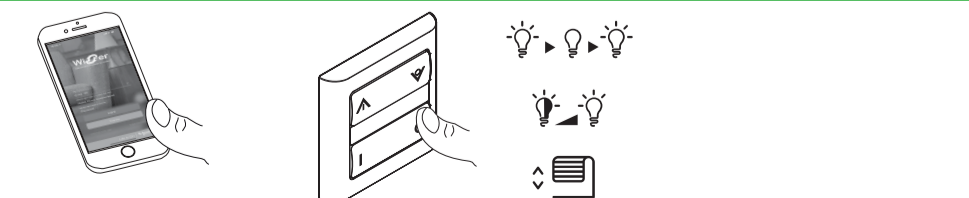
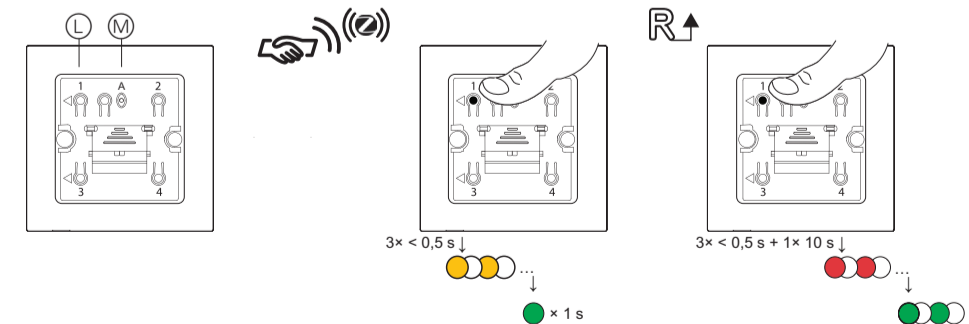
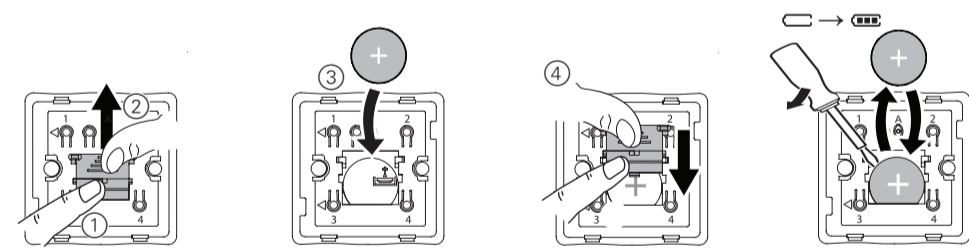
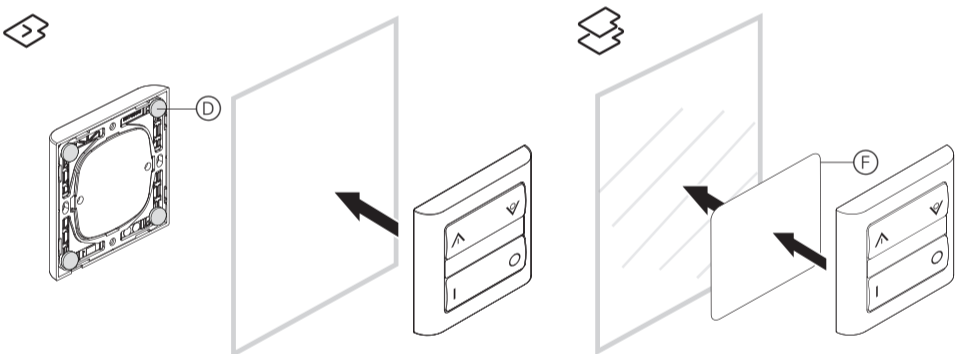
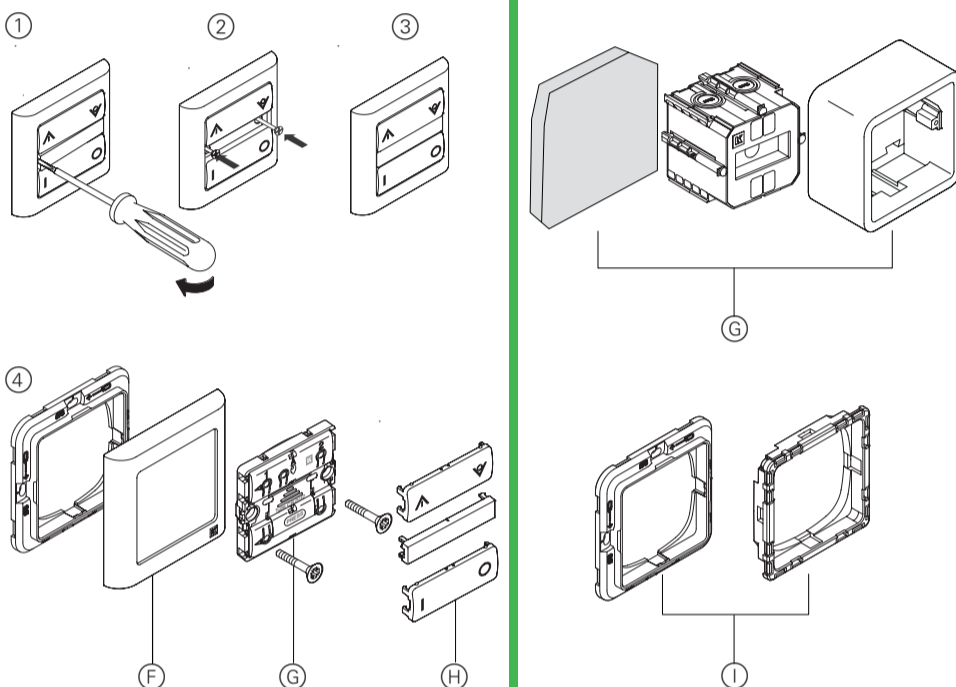
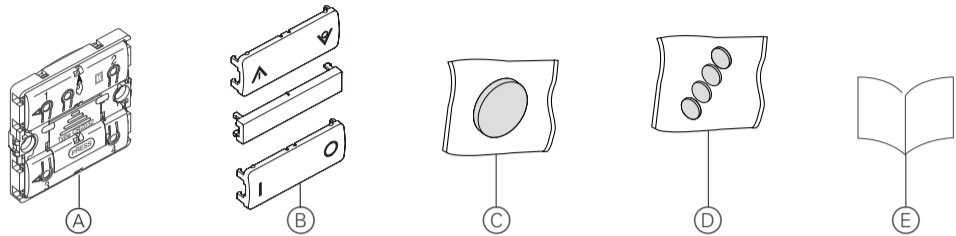

Forudsætninger

Download **Wiser app'en** til din smartphone / tablet, og installer **Wiser Gateway** for at konfigurere og styre dine Wiser enheder.

Yderligere information

Detaljeret produktinformation er tilgængelig online i systemvejledningen: Scan QR-koden eller følg linket.

<https://www1.lk.dk/wiser>

For din sikkerhed

▲ ▲ FARE

FARE FOR ELEKTRISK STØD, EKSPLOSION ELLER LYSBUE

Sikker elektrisk installation må kun udføres af kvalificerede fagfolk. Dygtige fagfolk skal have dybtgående viden på følgende områder:

- Tilslutning til fast installation
- Tilslutning af flere elektriske enheder
- Lægning af elektriske kabler
- Sikkerhedsstandarder, lokale regler og forskrifter

Manglende overholdelse af disse instruktioner kan resultere i død eller alvorlig personskade.

i Arbejde med strømforsyningen er nødvendig, hvis du monterer enheden på en vægdåse med 230 V a.c. vekselstrømskabler eller en eksisterende stikkontakt.

Lær produktet at kende

LK FUGA® Wiser batteritryk 4 slutte (i det følgende benævnt **enhed**) bruges til at styre en gruppe af Wiser-enheder inden for det samme Zigbee-netværk.

Enheden kan konfigureres via Wiser app'en eller kan parres med andre Wiser enheder.

Hvis batteriniveauet er lavt (under 10%), blinker statuslysdioden (M) rødt én gang, når der trykkes på en knap. Bemærk, at du skal fjerne den øverste tangent for at se statuslysdioden. Oplysninger om batteriniveau vil også være tilgængelige i app'en.

For mere information om konfiguration, se systemets brugervejledning.

Styringsmuligheder

Boligstyring: For at benytte enheden i din bolig gennem Wiser app'en, skal du have en Wiser Gateway.

Rumstyring: For at benytte enheden gennem andre Wiser enheder skal enhederne parres. Wiser enhederne skal være på det samme Zigbee-netværk.

Indhold i pakke

- (A) LK FUGA® Wiser batteritryk 4 slutte
- (B) Tangenter og midterbjælke (ikke inkluderet for 550D0001).
- (C) Batteri
- (D) Klæbepuder
- (E) Installations vejledning

i Vægdåse, rammer, tekniske rammer og skruer er ikke inkluderet i pakken.

Monteringsmuligheder

- (F) På glasflader: Brug dobbeltklæbende tape, f.eks. 505D7001 til BASELINE eller 505D7003 til SOFTLINE. (medfølger ikke)
- (G) Installationsmuligheder med skruer: Væg, installationsdåse, underlag
- (H) Ramme (ikke inkluderet)
- (I) Batteritryk uden tangenter og midterbjælke
- (J) Tangenter og midterbjælke
- (K) Installationsmuligheder med skruer: Tekniske rammer (ikke inkluderet)

Montering af enheden

- i** Ved installationsdåse, underlag eller væg skal du bruge monteringskruer. Vær opmærksom på at underlag ofte kræver et skruelindlæg som skal købes separat.
- For glatte overflader brug dobbeltklæbende tape, 505D7001 for BASELINE, 505D7003 for SOFTLINE (medfølger ikke).
- For glasoverflader brug klæbepuder eller dobbeltklæbende tape.

Bemærk: Installer ikke enheden på en metaloverflade, da det påvirker enhedens trådløse kommunikation og ydeevne.

Montering med skruer

- Fjern tangenter og midterbjælke.
- Indsæt enheden i en ramme.
- Placer enheden, hvor den skal monteres og skru den på plads. Se monteringsmuligheder (G) og (K).
- Påsæt tangenter og midterbjælke.
- Hvis der anvendes teknisk ramme, påsæt design ramme.

Montering ved hjælp af klæbepuder

- Fastgør klæbepuderne (D) i de fire hjørner på bagsiden af rammen.
- Monter enheden på overfladen.

Montering ved hjælp af klæbepuder og dobbeltklæbende tape

i Klæbepuderne (D) skal fastgøres til bagsiden af design rammen eller selve enheden.

- Påsæt den dobbeltklæbende tape (F) på glasoverflader, og undgå bobler eller folder.
- Monter enheden på den klæbende sølvfolie.

Isætning af batteri

▲ ADVARSEL

FARE FOR KEMISK FORBRÆNDING

Opbevar batterier utilgængeligt for børn. Ved indtagelse, søg omgående lægehjælp.

Manglende overholdelse af disse instruktioner kan resultere i alvorlig personskade eller død.

- 1 Tryk batteridækslet ned.
- 2 Skub opad for at fjerne det.
- 3 Indsæt batteriet med plus (+) symbolet vendt udad.
- 4 Fastgør batteridækslet ved at trykke det ind samtidig med at det presses det nedad.

i Batteridækslet er designet med børnesikring.

Udskiftning af batteri

i Bortskaf brugte batterier i overensstemmelse med lovgivningen.

Betjeningslementer

- (L) Betjeningstryk (Setup/Reset)
- (M) Status lysdiode

Indstilling af enheden

i Fjern øverste tangent for at få adgang til betjeningstryk (L) og lysdiode.

Opretter forbindelse til Wiser Gateway

Tryk kort (<0,5 s) på betjeningsstrykket (L) 3 gange for at oprette forbindelse til et tilgængeligt Zigbee-netværk. Status lysdioden blinker gult og bliver derefter grønt efter en vellykket forbindelse til Zigbee-netværket.

For mere information henvises til systemvejledning.

Parring til andre Wiser enheder

For at kontrollere produkter i rumstyringstilstand kan de parres med andre Wiser enheder inden for det samme Zigbee-netværk.

For mere information henvises til systemvejledning.

Nulstilling af enheden

Kort tryk (<0,5 s) på betjeningsstrykket (L) 3 gange, og derefter langt tryk (>10 s) på betjeningsstrykket (L) til lysdioden blinker rødt. Slip betjeningsstrykket og lysdioden stopper med at blinke når enheden er nulstillet.

Enheden genstarter og blinker grønt nogle sekunder. Efter nulstillingen vil status lysdioden være slukket for at spare batteri.

i Når enheden er nulstillet, slettes alle programmerings- og netværksdata.

Fejlfinding

Se systemvejledning.

Teknisk data

Batteri	CR2032
Batteri levetid	Op til 5 år (afhængig af brugmønster)
Kapslingsklasse	IP20
Frekvensområde	2405-2480 MHz
Maks. radiofrekvenseffekt transmitteret	<10 mW
Rækkevidde	100 m fri luft
Driftstemperatur	-10 °C til 50 °C
Relativ fugtighed	10% til 95%
Certifikation	Zigbee 3.0

Bortskaf enheden separat fra husholdningsaffald på et officielt opsamlingssted. Professionel genanvendelse beskytter mennesker og miljøet mod potentielle negative effekter.

Varemærker

- Wiser™ tilhører Schneider Electric SE, dets datterselskaber og tilknyttede virksomheder.
 - Zigbee® er et registreret varemærke tilhørende Zigbee Alliance.
 - Apple® og App Store® er mærkenavne eller registrerede varemærker tilhørende Apple Inc.
 - Google Play™ Store og Android™ er mærkenavne eller registrerede varemærker tilhørende Google Inc.
- Andre mærker og registrerede varemærker tilhører deres relevante ejere.

EU-overensstemmelseserklæring

Schneider Electric Danmark A/S erklærer hermed, at dette produkt er i overensstemmelse med de væsentlige krav og andre relevante bestemmelser i RADIO EQUIPMENT DIRECTIVE 2014/53 / EU. Overensstemmelseserklæringen kan downloades på adressen se.com/docs.

Lauritz Knudsen

Schneider Electric Danmark A/S, Laurtrupvang 1, 2750 Ballerup, Telefon: +45 88 30 20 00, www.lk.dk

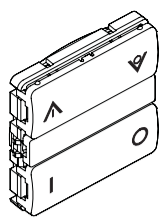

550D6001

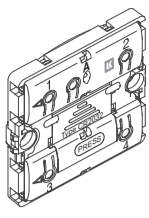

550D0001

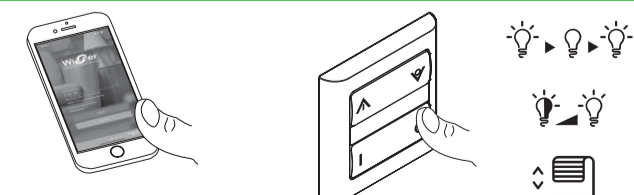
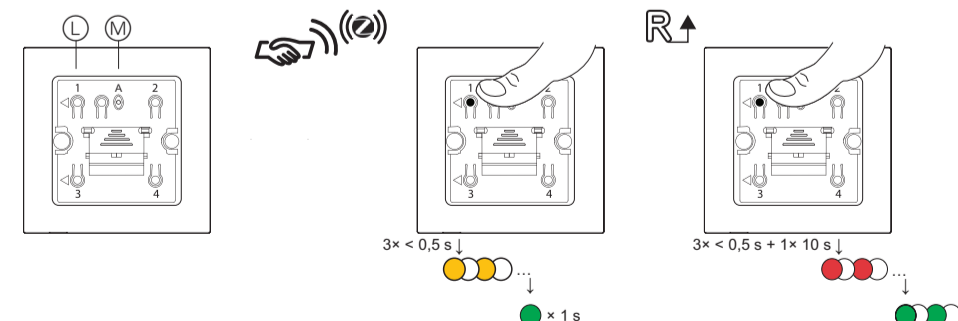
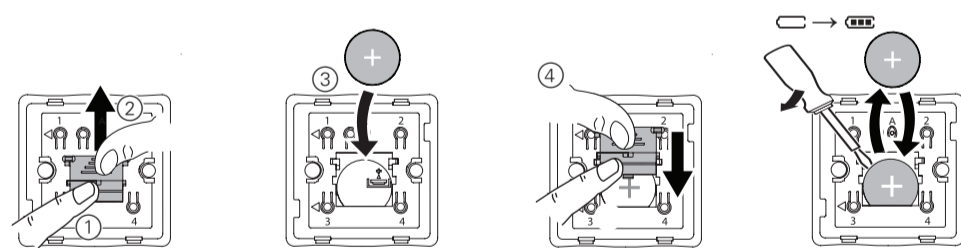
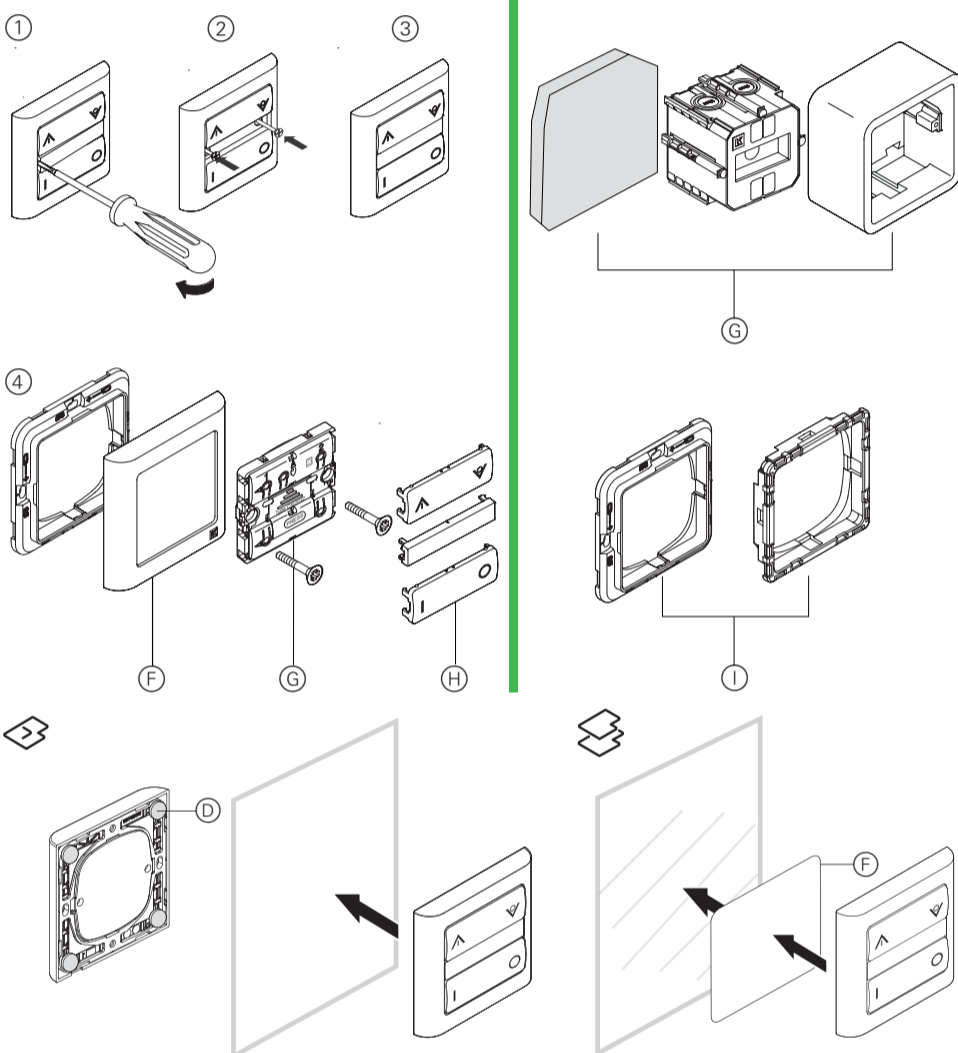
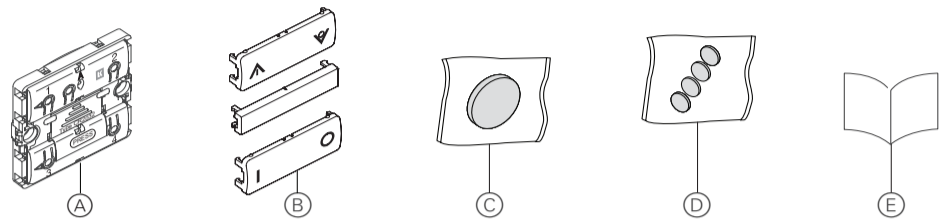

WiFer

**Prerequisites**

Download the **Wiser app** to your smartphone/tablet and install the **Wiser Gateway** to configure and control Wiser devices.

Additional system information

Detailed product information is available online in the **system user guide**: Scan the QR code or follow the link.

<https://www1.lk.dk/wiser>**For your safety****⚠ ⚠ DANGER****HAZARD OF ELECTRIC SHOCK, EXPLOSION, OR ARC FLASH**

Safe electrical installation must be carried out only by skilled professionals. Skilled professionals must prove profound knowledge in the following areas:

- Connecting to installation networks
- Connecting several electrical devices
- Laying electric cables
- Safety standards, local wiring rules and regulations

Failure to follow these instructions will result in death or serious injury.



Work on the power supply is necessary if you are mounting the device onto a wall box with 230 V AC cables or an existing switch/socket outlet combination.

Getting to know the product

The LK FUGA® Wiser wireless battery 4 button switch (hereinafter referred to as **device**) is used to control a group of Wiser devices within the same Zigbee network.

The device can be configured through Wiser app or can be paired with other Wiser devices.

If the battery is low (lower than 10%) the status LED (M) will blink red once when a button is pushed. Note that you need to remove the upper rocker to see the status LED. Information about battery level will also be available in the app.

For more information on configuration, refer to the system user guide.

Control options

Home control: To use the device in your home through the Wiser app, you will need the Wiser Gateway.

Room control: To use the device through other Wiser devices, it can be paired. Wiser devices has to be in the same Zigbee network.

Package contents

- (A) LK FUGA® Wiser wireless panel with 4 push-buttons
- (B) Rockers and coverplate. (For 550D0001 these are not included).
- (C) Battery
- (D) Adhesive pads
- (E) Installation instructions



The wall box, frames, technical frame, wall plugs and screws are not included in the package.

Mounting options

- (F) On glass surfaces: Use adhesive tape eg. 505D7001 for BASELINE or 505D7003 for SOFTLINE (not included)
- (G) Mounting base options with screws: Wall, wall box, installation box
- (H) Frame (not included)
- (I) Panel without rockers and cover plate
- (J) Rockers and cover plate.
- (K) Mounting option: Technical frames (not included)

Mounting the device

- For wall box, installation box, wood or wall use mounting screws. Please note that installation boxes often requires a screw insert which must be purchased separately.
- For smooth surface, use adhesive pads.
- For glass surface, use adhesive tape, 505D7001 for BASELINE, 505D7003 for SOFTLINE (not included).

Note: Do not install the device on a metal surface, as it affects the wireless communication and performance of the device.

Mounting using screws

- Remove tangents and center bar cover.
- Insert the device into a design frame.
- Place the unit where it is to be mounted and screw it into place. Please see mounting options (G) and (K).
- Attach tangents and center bar cover.
- If technical frame is used, put on a design frame.

Mounting using adhesive pads

- Affix the adhesive pads (D) at the four corners rear on the side of the frame.
- Mount the device on the surface.

Mounting using adhesive pads and adhesive tape

The adhesive pads (D) must be affixed to the design frame or the device itself.

Inserting the battery**⚠ WARNING****CHEMICAL BURN HAZARD**

Keep batteries out of reach of children. If swallowed, seek immediate medical attention.

Failure to follow these instructions can result in serious injury or death.

- 1 Press the battery cover.
- 2 Slide towards up to remove.
- 3 Insert the battery with plus (+) symbol facing outward.
- 4 Secure the battery cover by pressing and sliding towards down.



The battery cover is designed with child lock protection.

Replacing the battery

Dispose used batteries as per statutory regulations.

Operating elements

- (L) Push button (Setup/Reset)
- (M) Status LED

Setting the device

Remove the rocker from the device to see the status LED.

Connecting to the Wiser Gateway

Short press (<math>< 0,5\text{ s}</math>) the push button (L) 3 times to connect to an available Zigbee network. The status LED blinks amber and then turns green upon successful connection to the Zigbee network.

For more information refer to the system user guide.

Pairing to other Wiser devices

To control products in a room control mode, it can be paired with other Wiser devices within the same Zigbee network.

For more information refer to the system user guide.

Resetting the device

Short press (<math>< 0,5\text{ s}</math>) the push button (L) 3 times and then long press (>10 s) the push button (L) until the status LED blinks red. Then release the push button, the status LED stops blinking upon successful reset of the device.

The device restarts and blinks green for a few seconds. After reset, the LED turns off to save battery.



After the device is reset all the programming and network data will be deleted.

Troubleshooting

Refer to the system user guide.

Technical data

Battery	CR2032
Battery life	Up to 5 years (depending frequency of use)
IP rating	IP20
Operating frequency	2405-2480 MHz
Max. radio-frequency power transmitted	<math>< 10\text{ mW}</math>
Range	100 m open space
Operating temperature	-10 °C to 50 °C
Relative humidity	10% to 95%
Certification	Zigbee 3.0



Dispose of the device separately from household waste at an official collection point. Professional recycling protects people and the environment against potential negative effects.

Trademarks

- Wiser™ is a trademark and the property of Schneider Electric SE, its subsidiaries and affiliated companies.
 - Zigbee® is a registered trademark of the Zigbee Alliance.
 - Apple® and App Store® are brand names or registered trademarks of Apple Inc.
 - Google Play™ Store and Android™ are brand names or registered trademarks of Google Inc.
- Other brands and registered trademarks are properties of their relevant owners.

EU Declaration of conformity

Hereby, Schneider Electric Danmark A/S, declares that this product is in compliance with the essential requirements and other relevant provisions of RADIO EQUIPMENT DIRECTIVE 2014/53/EU. Declaration of conformity can be downloaded on: se.com/docs.

Lauritz Knudsen

Schneider Electric Danmark A/S, Lautrupvang 1, 2750 Ballerup, Phone: +45 88 30 20 00, www.lk.dk