

PRODUCT DATASHEET

DL SLIM DN 210 18 W 3000 K WT

DOWNLIGHT SLIM ROUND | Flat downlights with integrated driver, round shape

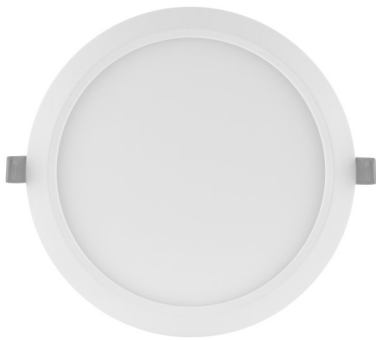

AREAS OF APPLICATION

- Direct replacement for luminaires with compact fluorescent lamps
- General illumination
- Public areas
- Stairways
- Corridors
- Foyers
- Shops

PRODUCT BENEFITS

- Very slim housing
- Low installation depth
- High luminous efficacy
- Energy savings up to 60 % (compared to luminaires that use CFL lamps)
- Very homogenous light
- Functional design
- Easy installation with fast connection
- Simple installation thanks to integrated driver

PRODUCT FEATURES

- Small visible bezel
- Connector box with push wire terminal for tool-free connection
- Light guide made of non-yellowing PMMA for long lifetime



TECHNICAL DATA

Electrical data

Nominal wattage	18.00 W
Operating mode	Integrated LED driver
Nominal voltage	220...240 V
Power factor λ	0.50
Mains frequency	50/60 Hz
Max. no. of lum. on circuit break. B16 A	44
Max. no. of lum. on circuit break. C10 A	35
Max. no. of lum. on circuit break. C16 A	56
Inrush current	17.0 A
Total harmonic distortion	< 20 %
Inrush current time T_{h50}	56 μ s

Luminaire control gear data

Output current	295 mA
ECG - Output ripple current	<6.5 %

Photometrical data

Color temperature	3000 K
Luminous flux	1530 lm
Luminous efficacy	85 lm/W
Standard deviation of color matching	<6 sdcM
Light color (designation)	Warm White
Color rendering index Ra	>80

Light technical data

Beam angle	120 ° ¹⁾
------------	---------------------

¹⁾ ZMP_110132

Dimensions & weight

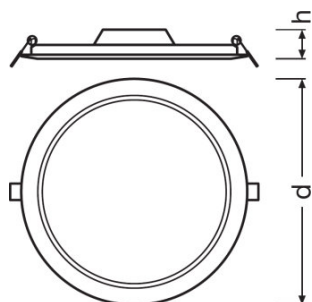

Diameter	225.0 mm
Height	30.0 mm
Product weight	435.00 g
Mounting diameter	210.0 mm

Colors & materials

Body material	Polycarbonate (PC)
Product color	White
Housing color	White
Cover material	Polycarbonate (PC)
Light emitting surface material	Polycarbonate

Temperatures & operating conditions

Ambient temperature range	-20...+50 °C
----------------------------------	--------------

Lifespan

Number of switching cycles	50000
Lifespan L70/B50 at 25 °C	30000 h
Lifespan L80/B10 at 25 °C	20000 h
Lifespan L90/B10 at 25 °C	12000 h

Additional product data

Mounting type	Recessed
Mounting location	Ceiling / Wall

Capabilities

Dimmable	No
Type of connection	Screwless terminal, 2-Pole
LED module replaceable	Not replaceable

Certificates & standards

Protection class IK (shock resistance)	IK03
Glow Wire Test according to IEC 60695-2-12	650 °C
Photobio. safety group acc. to EN62471	RG0
Protection class	II
Type of protection	IP20
Standards	CE/CB/EAC/RoHS

Logistical data

Temperature range at storage	-30...+70 °C
------------------------------	--------------

Light Distribution

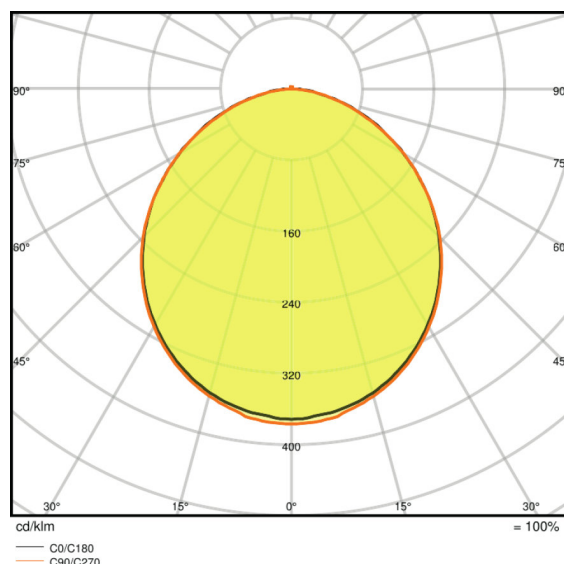
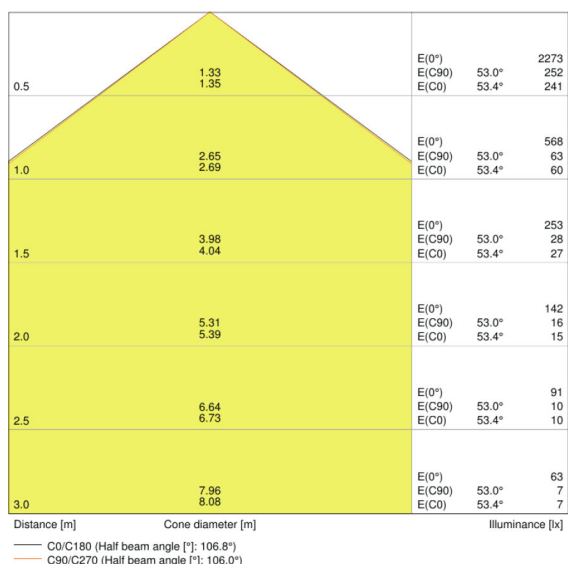

LDC typ cone

LDC typ polar

EQUIPMENT / ACCESSORIES

- Surface mounting frames available as accessories

LOGISTICAL DATA

Product code	Packaging unit (Pieces/Unit)	Dimensions (length x width x height)	Gross weight	Volume
4058075079090	Folding carton box 1	45 mm x 250 mm x 230 mm	518.00 g	2.59 dm ³

4058075079106	Shipping carton box 6	290 mm x 270 mm x 250 mm	3439.00 g	19.58 dm ³
---------------	--------------------------	--------------------------	-----------	-----------------------

The mentioned product code describes the smallest quantity unit which can be ordered. One shipping unit can contain one or more single products. When placing an order, for the quantity please enter single or multiples of a shipping unit.

ADDITIONAL CATALOG INFORMATION

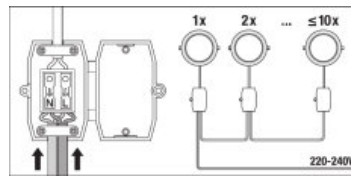
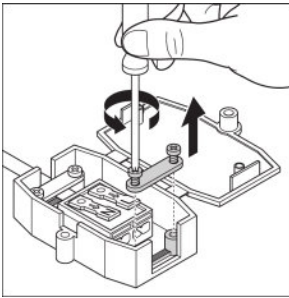

REFERENCES / LINKS

For Guarantee see

▶ www.ledvance.com/guarantee

DISCLAIMER

Subject to change without notice. Errors and omission excepted. Always make sure to use the most recent release.