

## Ø315/Ø425 JESMIG BRØNDDÆKSEL

### T1



**T1-50, T1-70 og T1-135-70**

Tekniske data	T1-50	T1-70	T1-135-70
Brøndstørrelse	Ø315/Ø425 mm	Ø315/Ø425 mm	Ø315/Ø425 mm
Ydre karm mål Y	527 x 475 mm	527 x 475 mm	527 x 475 mm
Ydre dæksel mål M	400 x 400 mm	400 x 400 mm	400 x 400 mm
Lysåbning L	367 x 367 mm	367 x 367 mm	367 x 367 mm
Belægningshøjde	10-55 mm	60-75 mm	60-75 mm
Karmhøjde H	59 mm	79 mm	135 mm
Max belastning m/sten	A 50 / 5 ton	A 50 / 5 ton	A 50 / 5 ton
Brønddæksel vægt u/b	7 kg.	8 kg.	8 kg.

Varenr.	DB nr.	Beskrivelse	Materiale:	EN-klasse	Total Vægt i Kg:
227099100	1722126	Ø315/Ø425	Galvaniseret Smedejern	A 50	14
227099120	1722166	Ø315/Ø425	Galvaniseret Smedejern	A 50	16
2270 99127	1978786	Ø315/Ø425	Galvaniseret Smedejern	A 50	18

Ved anvendelse af Jesmig tætningslister, kan der opnås en lugttæthed på 99 % gennem dækslet

Testet iht. norm. DS/EN 124-1, 3:2015 rapportnummer: 2021-0308

2021-24-03

## Ø315/Ø425 JESMIG BRØNDDÆKSEL

### T1



T1-50, T1-70 og T1-135-70

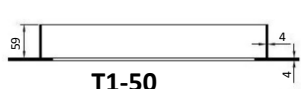

T1-50

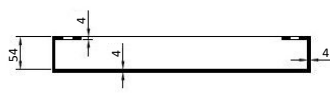

T1-50

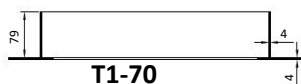

T1-70



T1-70

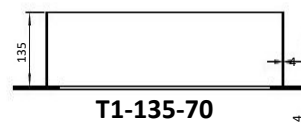

T1-135-70

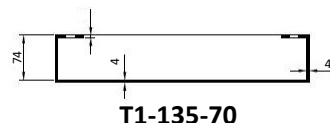

T1-135-70

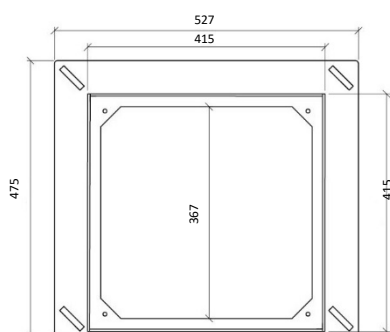

T1-50 , T1-70 og T1-135-70

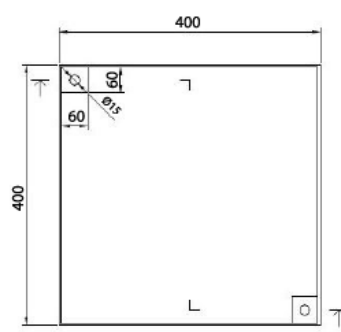

T1-50, T1-70 og T1-135-70