

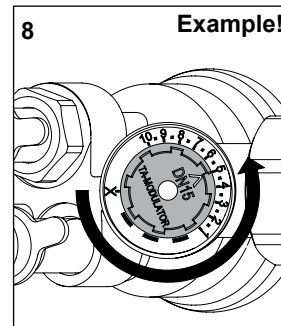

ΔH

310 800-01
02.2021

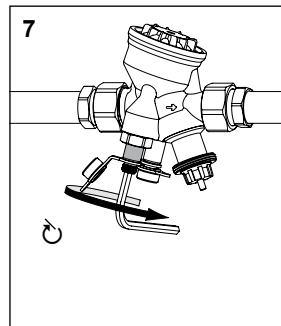
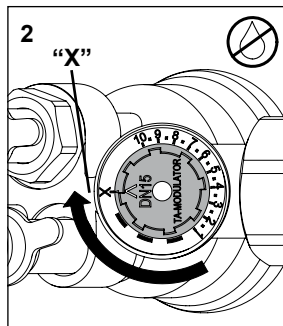
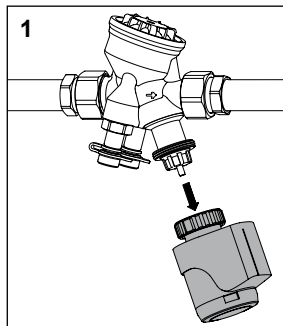

TA-Modulator

DN 15-32

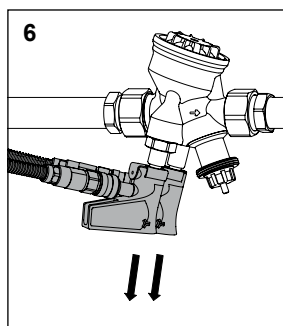
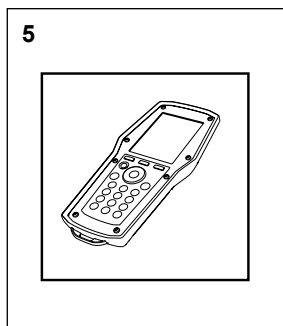
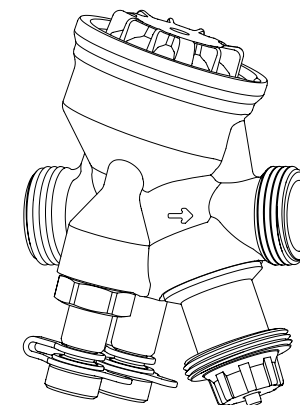
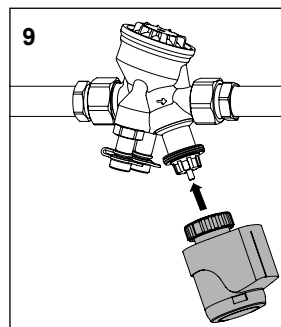
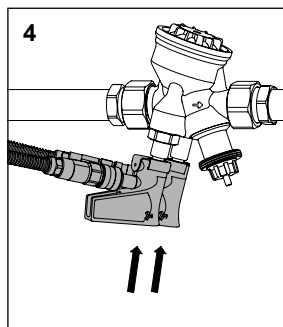
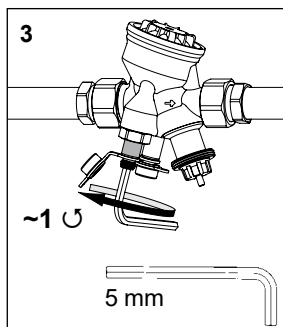

	DN 15	52 164-901		30 mm
	DN 20	52 164-902		2001-30.700
	DN 25	52 164-903		(DN 15-20)
	DN 32	52 164-904		

TA-Modulator
www.imi-hydronic.com

We reserve the right to introduce technical alterations without prior notice.

Pos	q _{max}							
	DN 15 [l/h]	1/2" [US gpm]	DN 20 [l/h]	3/4" [US gpm]	DN 25 [l/h]	1" [US gpm]	DN 32 [l/h]	1 1/4" [US gpm]
1	92	0.41	200	0.88	340	1.50	720	3.17
2	114	0.50	260	1.14	440	1.94	960	4.23
3	140	0.62	360	1.59	600	2.64	1350	5.94
4	170	0.75	460	2.03	810	3.57	1750	7.71
5	210	0.92	565	2.49	1010	4.45	2150	9.47
6	265	1.17	670	2.95	1200	5.28	2530	11.1
7	325	1.43	770	3.39	1350	5.94	2850	12.5
8	390	1.72	850	3.74	1520	6.69	3130	13.8
9	445	1.96	920	4.05	1640	7.22	3380	14.9
10	480	2.11	975	4.29	1750	7.71	3600	15.8

q_{max} =

- l/h (US gpm) at each pre-setting and fully open valve plug.
- l/h bei der jeweiligen Voreinstellung und voll geöffnetem Regelkegel.
- l/h pour chaque pré-réglage, la cône de la vanne étant complètement ouverte.
- l/h van elke voorinstelstand en volledig geopende afsluiterkegel.
- l/h para cada preajuste, estando el obturador en la posición totalmente abierta.
- l/h em cada posição de pré-ajuste e o disco da válvula totalmente aberto.
- l/h con ogni pre-impostazioni e con la valvola completamente aperta.
- l/hod pri danom prednastavení a plne otvorenej regulačnej kúželke.
- l/h pri dani prednastavitvi in popolnoma odprtem vretenu ventila.
- l/h pentru fiecare presetare si vana complet deschisa.
- l/h pri svakom prednamještanju i potpuno otvorenom ventili.
- l/h na svojoj pred-podešenoj poziciji i potpuno otvorenom ventili.
- l/h reguleerosa täiesti avatud asendis vastavalt eelseadearvule.
- l/h katram iepriekšiestatījumam un pilnībā atvērtam vārstam.
- l/h prie kiekvienos nustatymo padėties esant pilnai atidarytam vožtuvui.
- l/h vid respektive förinställning och fullt öppen ventilkägla.
- l/h ved angitt forinnstilling og full åpen ventilkjegle.
- l/h kyseisellä esisäätöarvolla ventiliikara täysin auki.
- l/h ved respektiv forinstilling og fuldt åben ventilkjegle.

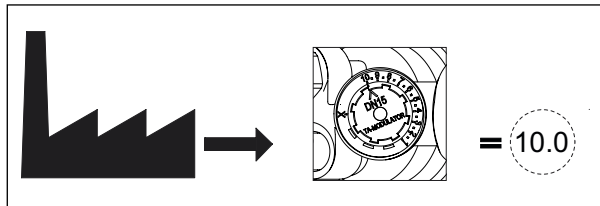

Δp insert PPS:
0°C – +90°C
(+32°F – +194°F)

PN 16 (230 psi)

ΔpV_{max}: 400 kPa = 4 bar (58 psi)

ΔpV_{min} DN 15-20 (1/2"-3/4"):
15 kPa = 0.15 bar (2.2 psi)

ΔpV_{min} DN 25-32 (1"-1 1/4"):
23 kPa = 0.23 bar (3.3 psi)

Δp insert AMETAL®:
-20° – +120°C
(-4°F – +248°F)

PN 16 (230 psi)

ΔpV_{max}: 600 kPa = 6 bar (87 psi)

ΔpV_{min} DN 15-20 (1/2"-3/4"):
15 kPa = 0.15 bar (2.2 psi)

ΔpV_{min} DN 25-32 (1"-1 1/4"):
23 kPa = 0.23 bar (3.3 psi)

TA-Modulator + EMO TM

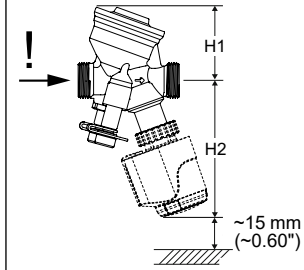

DN	H1	H2
15	55	107
20	64	107

Size	H1	H2
1/2"	2.17"	4.21"
3/4"	2.52"	4.21"

TA-Modulator + TA-Slider 160

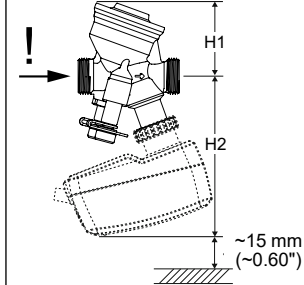

DN	H1	H2
15	55	119
20	64	119
25	64	130
32	78	133

Size	H1	H2
1/2"	2.17"	4.68"
3/4"	2.52"	4.68"
1"	2.52"	5.12"
1 1/4"	3.07"	5.24"

EMO TM/TA-Slider 160

