

WORKSHOP SPECIFICATIONS

PLEXO³

IP65 CABINETS



THE GLOBAL SPECIALIST IN ELECTRICAL
AND DIGITAL BUILDING INFRASTRUCTURES



With their **IP 65** weatherproof protection and optimised dimensions, Plexo³ cabinets, from 2 to 4 x 18 modules, can be used for distribution up to **125 A**.

The design of Plexo³ cabinets makes them suitable for use in commercial or industrial applications, as well as in **public** and **high-rise buildings**.

The available accessories, including those for joining a multi-function sleeve, enable the Plexo³ cabinet to be equipped with one or more flush-mounted Plexo mechanisms, P17 industrial sockets, and Osmoz control and signalling units.

LEGAL INFORMATION

Presentation pictures do not always include Personal Protective Equipment (PPE), but this is a legal and regulatory obligation that must be scrupulously respected.

In accordance with its continuous improvement policy, Legrand reserves the right to change the specifications and illustrations without notice. All illustrations, descriptions and technical information included in this document are provided as indications and cannot be held against Legrand.

TABLE OF CONTENTS

Safety instructions	2
Characteristics.....	4
Product range.....	4
Schematic view of a Plexo ³ cabinet	5
Dimensions.....	6
Preparation of the cabinets	6
Delivery condition of Plexo ³ cabinets	7
Delivery condition of multi-function sleeves	7
Accessories for the cabinet	
Joining kit Cat. No 0 019 67	8
Kit for Plexo wiring accessories Cat. No 0 019 71	8
Fixing accessories for terminal blocks Cat. No 0 019 72/73.....	9
Lock Cat. No 0 019 66.....	9
Sealing kit Cat. No 0 019 68.....	9
Fixing lugs Cat. No 0 019 69	9
Solid faceplates Cat. No 0 019 64/65.....	10
Perforated plates Cat. No 0 019 62/4 018 53.....	10
Hinges Cat.no 0 019 70.....	10
Using the cabinets	
Running the cables	11
Mounting modular and moulded case products	12
Accessories for sleeves	12
Distribution systems	13
Removable chassis and rails	14
Reversible door	14
Marking the faceplates.....	14
Fixing the cabinets.....	15
Accessories & spare parts.....	18

SAFETY

INSTRUCTIONS

General information

- Use only the products and accessories recommended by the Legrand Group in the catalogue, instructions, technical data sheets and all other documents provided by Legrand (hereinafter referred to as «the Documentation») in compliance with the installation rules.
- Improper installation and/or use may result in the risk of arcing in the enclosure, overheating or fire. The enclosures must be used under normal conditions, they must not be subjected to Voltage / Current / Temperature values other than those specified in the Documentation.
- Legrand declines all responsibility for any modification or repair of the equipment making up the enclosure that is not authorized by the Legrand Group, as well as any failure to comply with the rules and recommendations specified by Legrand in the Documentation. In addition, in the cases mentioned above, the warranty granted by Legrand will not be applicable.
- It is necessary to check that the characteristics of the products are appropriate for their environment and use during maintenance operations, and to refer to the Documentation. If you have any questions or require clarification, please contact Legrand Group.
- The installation, use and maintenance of the enclosures and their components must be carried out by qualified, trained and authorized personnel, in accordance with the regulations in force in each country.



RISK OF ELECTRIC SHOCK, BURNS AND EXPLOSION.

- People working on the installation must have the appropriate electrical authorizations for the work to be carried out.
- Wear the PPE (Personal Protective Equipment) necessary to work on live products.
- Respect the safety rules related to electrical work.
- Improper electrical and mechanical use of equipment can be dangerous and may result in personal injury or damage to property.
- Depending on the maintenance operations to be carried out, partial or total power cuts of the enclosure concerned should be planned before any work.
- When performing operations that involve access to the inside of the enclosure, be aware of the risk of burns before touching any products or metal parts.
- Before turning the power back on, make sure that there are no foreign bodies and that all physical protections have been put back in place (e.g.: screens, covers, shields).

Any failure to strictly apply the procedures and to respect these recommendations, could lead to serious risk of accident, endangering people and property (in particular, without limitation, risk of burns, electric shocks, etc.).



 The rules and recommendations in this document are based on our knowledge of the typical conditions of use of our products in the fields of application usually encountered. However, it is always the customer's responsibility to verify and validate that Legrand products are suitable for its installation and use.

The customer must ensure proper installation, maintenance and operation of the equipment to avoid any risk of injury to personnel or damage to property in the event of product failure, especially for applications that require a very high level of safety (e.g., those in which the failure of a component may endanger human life or health).

The rules for storage, handling, installation and maintenance and the appropriate precautions and warnings must be strictly observed and applied.

PLEXO³

CABINETS

CHARACTERISTICS

- Class II insulated cabinet
- IP 65 - IK 09 weatherproof cabinets
- UV resistant (according to ISO 4892-2)
- Self-extinguishing: 650°C (cabinets supplied without terminal blocks)/ 750°C (cabinets supplied with terminal blocks)
- Compliant with IEC 62208: allows assemblies to be manufactured in accordance with IEC 61439-3
- Color
 - Box: light grey L750 a
 - Cover: dark grey RaL 7046/R746 a
 - Document holder: transparent blue
- Rated operating and insulation voltage: 400 Vac-50/60 Hz
- Max. short-circuit current: 10 kA
- Max. permissible nominal current:
 - Cat.no 0 019 02/04/06 & 6 019 32/94/96 = 32 A
 - Cat.no 0 019 08 & 6 019 98 = 40 A
 - Cat.no 0 019 21/24 & 6 018 31/35 = 63 A
 - Cat.no 0 019 22/23/25 & 6 018 32/33/36 = 90 A
 - Cat.no 0 019 26/27 & 6 018 37/38 = 125 A



The PEP (Product Environmental Profile) sheet is available in the Legrand E-catalogue.

PRODUCT RANGE

the range comprises 11 sizes of cabinet :

- 2 to 8 modules with 1 row
- 12 modules with 1 to 3 rows
- 18 modules with 1 to 4 rows



NUMBER OF ROWS	NUMBER OF MODULES	CABINETS (CAT.NOS)		MULTI-FUNCTION SLEEVES (CAT.NOS)	
		Cabinets supplied with terminal blocks (France)	Cabinets supplied without terminal blocks (Export)	Vertical	Horizontal
1	2 (+1)	0 019 02	6 019 32		
	4	0 019 04	6 019 94		
	6	0 019 06	6 019 96		
	8	0 019 08	6 019 98		
	12	0 019 21	6 018 31		0 019 19
	18	0 019 24	6 018 35		0 019 20
2	24 (2 x 12)	0 019 22	6 018 32	0 019 17	0 019 19
	36 (2 x 18)	0 019 23	6 018 33		0 019 20
3	36 (3 x 12)	0 019 25	6 018 36	0 019 18	0 019 19
	54 (3 x 18)	0 019 26	6 018 37		0 019 20
4	72 (4 x 18)	0 019 27	6 018 38		0 019 20

SCHEMATIC VIEW OF A PLEXO³ CABINET

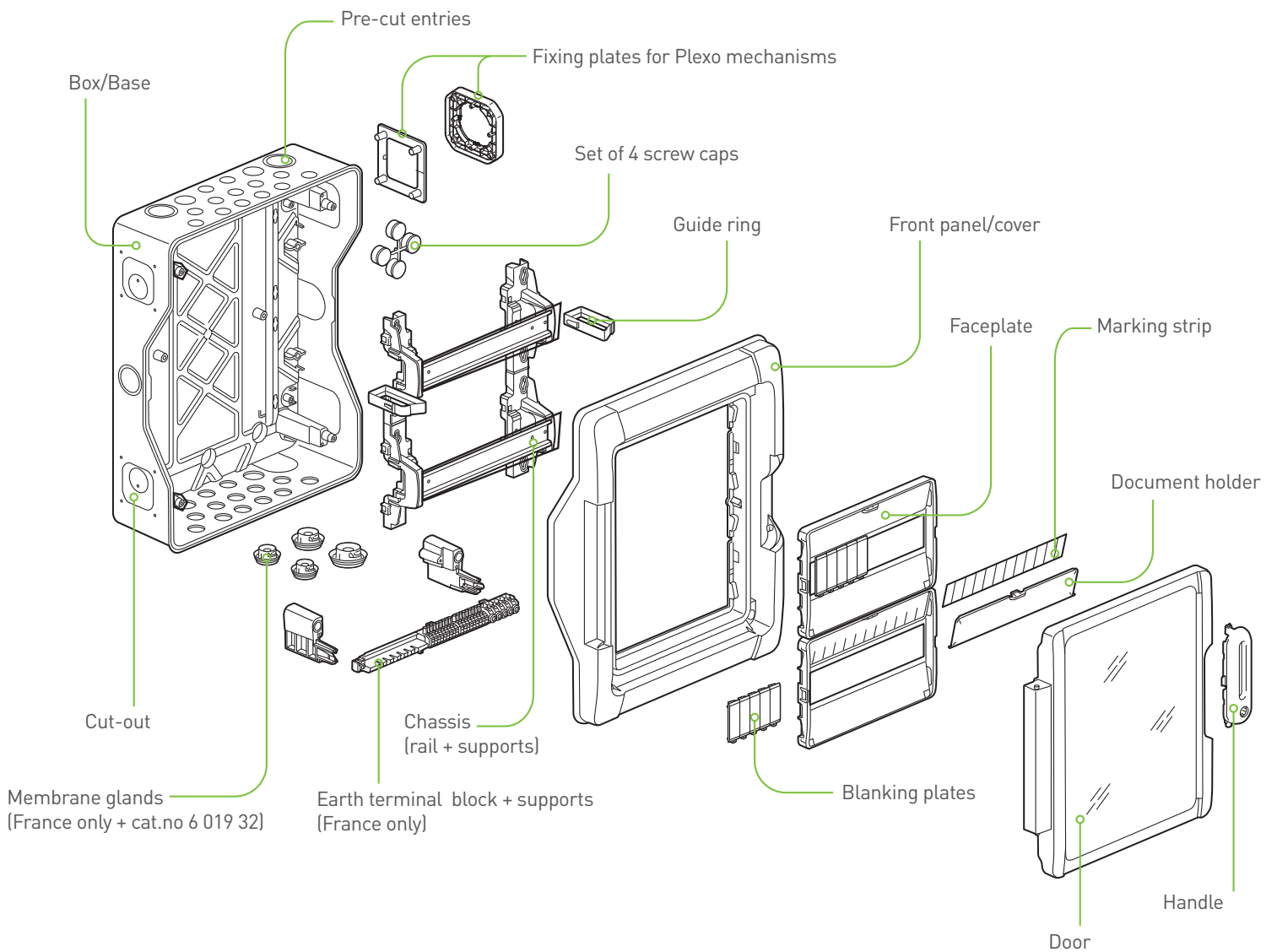

DIMENSIONS

2, 4, 6 AND 8-MODULE CABINETS

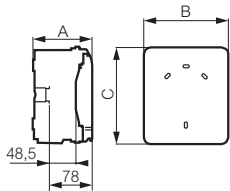

CAT.NOS		DIMENSIONS (mm)		
France	Export	A	B	C
0 019 02	6 019 32	109	93	174
0 019 04	6 019 94	115,6	128	200
0 019 06	6 019 96	115,6	164	200
0 019 08	6 019 98	115,6	200	200

12 AND 18-MODULE CABINETS

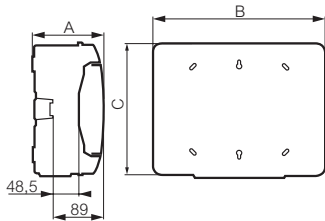

RÉFÉRENCES		COTES (mm)		
France	Export	A	B	C
0 019 21	6 018 31	141	340	282
0 019 22	6 018 32	161	340	432
0 019 23	6 018 33	161	340	622
0 019 24	6 018 35	141	448	282
0 019 25	6 018 36	161	448	432
0 019 26	6 018 37	161	448	622
0 019 27	6 018 38	161	448	822

HORIZONTAL MULTI-FUNCTION SLEEVES

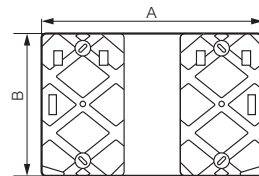

CAT.NO	DIMENSIONS (mm)	
	A	B
0 019 19	340	220
0 019 20	448	220

GAINES MULTIFONCTIONS VERTICALES

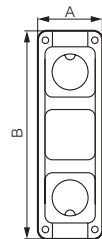

CAT.NOS	DIMENSIONS (mm)		NB DE POSTES
	A	B	
0 019 17	137	432	3
0 019 18	137	622	4

PREPARATION OF THE CABINETS



Plexo³ 2 to 8-module cabinets are supplied individually in cellophane packaging, and 12 and 18-module versions are supplied in cardboard packaging. the covers are supplied in place but not fixed. the doors of Plexo3 cabinets are protected against scratches by a transparent film. the cardboard packaging can be re-used for dispatching the cabinet already assembled.



The front panel is removed by unscrewing the 4 screws using a Pozidriv no. 2 screwdriver. the recommended torque when replacing it is 2 nm. these screws are stainless steel to provide excellent corrosion resistance.

DELIVERY CONDITION OF PLEXO³ CABINETS

CAT.NOS		NUMBER OF IP 2X TERMINAL BLOCKS			NUMBER OF BLANKING PLATES	NUMBER OF GUIDE RINGS	FIXING KIT FOR PLEXO WIRING ACCESSORIES	BLANK PAPER MARKER STRIP	DOCUMENT HOLDER INTEGRATED IN THE FACEPLATES	CAPS FOR FIXING SCREWS
		Auto terminals	Screw terminals							
		1.5 to 4 mm ²	6 to 25 mm ²	6 to 35 mm ²	5 modules					
FRANCE	0 019 02	-	-	-	-	-	-	1 x 2 modules	NO	-
	0 019 04	6	1	-	-	-	-	1 x 4 modules	YES	4
	0 019 06	6	1	-	-	-	-	1 x 6 modules	YES	4
	0 019 08	6	1	-	-	-	-	1 x 8 modules	YES	4
	0 019 21	9	5	-	1	-	-	1 x 12 modules	YES	4
	0 019 22	18	5	-	2	2	1	2 x 12 modules	YES	4
	0 019 23	27	5	-	2	3	1	3 x 12 modules	YES	4
	0 019 24	18	5	-	1	-	-	1 x 18 modules	YES	4
	0 019 25	27	5	-	2	2	1	2 x 18 modules	YES	4
	0 019 26	36	5	-	3	3	1	3 x 18 modules	YES	4
0 019 27	45	5	5	3	4	1	4 x 18 modules	YES	4	
EXPORT	6 019 32	-	-	-	-	-	-	1 x 2 modules	NO	-
	6 019 94	-	-	-	-	-	-	1 x 4 modules	NO	4
	6 019 96	-	-	-	-	-	-	1 x 6 modules	NO	4
	6 019 98	-	-	-	-	-	-	1 x 8 modules	NO	4
	6 018 31	-	-	-	-	-	-	1 x 12 modules	NO	4
	6 018 32	-	-	-	-	-	-	2 x 12 modules	NO	4
	6 018 33	-	-	-	-	-	-	3 x 12 modules	NO	4
	6 018 35	-	-	-	-	-	-	1 x 18 modules	NO	4
	6 018 36	-	-	-	-	-	-	2 x 18 modules	NO	4
	6 018 37	-	-	-	-	-	-	3 x 18 modules	NO	4
	6 018 38	-	-	-	-	-	-	4 x 18 modules	NO	4



Earth terminal block: automatic connection

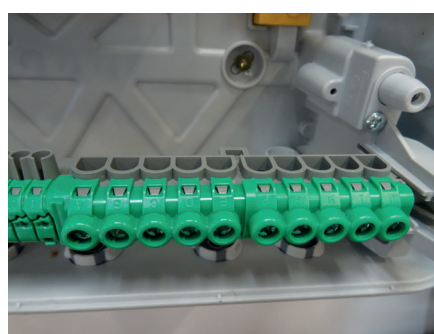

Earth terminal block: screw terminals



5 modules separable blanking plates

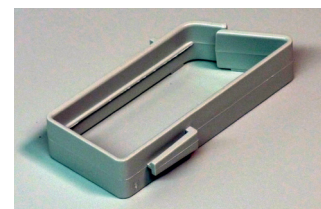

Guide ring

DELIVERY CONDITION OF MULTI-FUNCTION SLEEVES

CAT.NOS	HINGES	FIXING SCREWS FOR SOCKETS ON FRONT PANEL	CAPS FOR FIXING SCREWS
0019 17	2	12	4
0019 18	2	16	4
0019 19	-	-	4
0019 20	-	-	4

ACCESSORIES FOR THE CABINET

ACCESSORIES FOR THE CABINET

JOINING KIT CAT.NO 0 019 67

The joining kit, cat. no 001967, is used to join 2 cabinets of the same or different heights horizontally, or 2 cabinets of the same width vertically, or to join a vertical or horizontal multi-function sleeve to a Plexo3 cabinet. Joined cabinets or sleeves must also be fixed to the wall (see page 14).

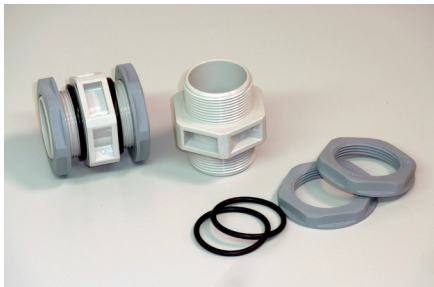

this kit comprises 2 identical accessories which provide (each) a 26 mm diameter feedthrough for cables while maintaining

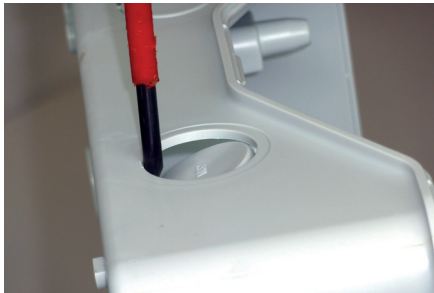

overall IP 65 protection.

There are 32 mm diameter cut-outs on the sides of the cabinets for fitting the joining accessories. there are similar cut-outs on the sides of the vertical sleeves, and on the top and bottom of the horizontal sleeves.



Joining accessories enable cables to be run between 2 cabinets.

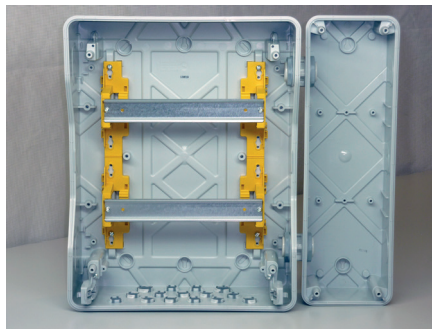

Cabinet joined to a vertical sleeve.



Cabinet joined to a horizontal sleeve.

i Two kits, Cat. no 0 019 67, must be used to join 18-module cabinets to a horizontal sleeve.

KIT FOR PLEXO WIRING ACCESSORIES CAT. NO 0 019 71



Plexo³ cabinets with at least 2 rows are supplied with 2 fixing plates for Plexo complete flush mounting wiring accessories. These accessories are also available under cat. no 0 019 71.



These cabinets have 4 rectangular cut-outs, 2 on each side, for fitting Plexo wiring accessories.

Screw the 2 supports together using the screws provided.

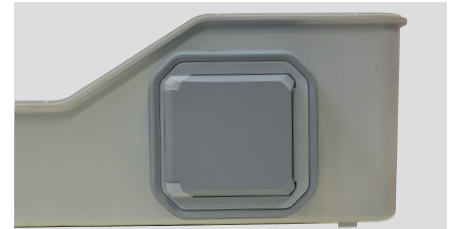
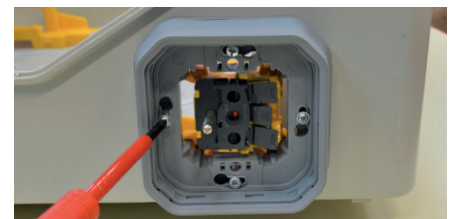
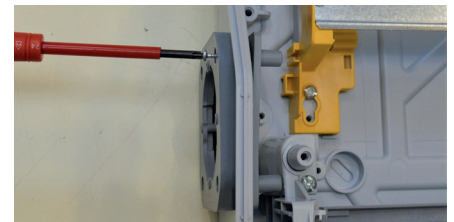

FIXING ACCESSORIES FOR TERMINAL BLOCKS CAT. NO 0 019 72/73

A single or double support for terminal blocks can be added at the top or bottom of the cabinets, using accessories cat. no 0 019 72 or 0 019 73.

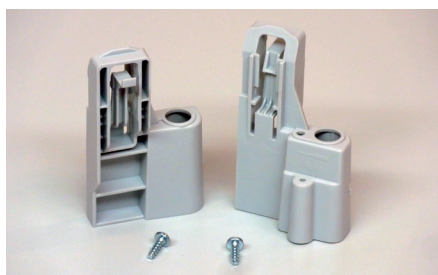

Single support cat. no. 0 019 72 for 1 or 2 row cabinets

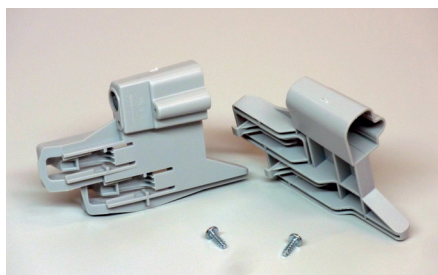

Double support cat. no 0 019 73 for 3 or 4 row cabinets

These accessories take empty supports for terminal blocks cat. no 0 048 17 (12-module cabinets) and cat. no 4 048 21 (18-module cabinets) on which empty screw terminal blocks cat. nos 0 048 01 to 07 can be installed.



LOCK CAT.NO 0 019 66



Plexo³ cabinets are supplied without a door lock. Lock cat. no 0 019 66 is used to lock the door with a no. 850 key.

SEALING KIT CAT. NO 0 019 68

i Different types of drive cam are used for 2 to 8-module cabinets and 12 to 18-module cabinets.

The kit is used to seal access to the inside of the Plexo³ cabinet. Its contents are used to seal 2 fixing screws on the front panel and several faceplates (up to 4 faceplates per kit) the sealing kit is passed through the faceplate via a cut-out which must first be knocked.



Sealing the screws on the front panel



Sealing the faceplates

FIXING LUGS CAT. NO 0 019 69

The fixing lugs (4 per kit) are used to attach Plexo³ cabinets to the wall using fixing points outside the enclosure. there is therefore no need to dismantle the cabinet.



The lugs can be positioned horizontally or vertically, apart from on the 2-module cabinet cat. no 0 019 02 / 6 019 32.

ACCESSORIES FOR THE CABINET

SOLID FACEPLATES CAT. NO 0 019 64/65

Solid faceplates, cat. no 0 019 64 for 12-module cabinets (with 2 or more rows) and cat. no 0 019 65 for 18-module cabinets (with 2 or more rows), are used to hide non-modular devices mounted on perforated plates and make it possible to flush mount devices.



Usable dimensions :

CAT.NOS	WIDTH	HEIGHT
0 019 64	215	145
0 019 65	324	145

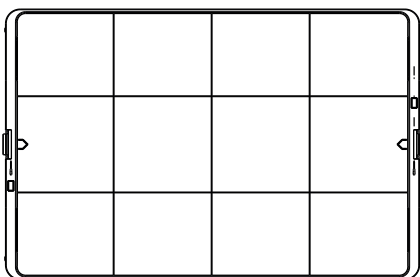

PERFORATED PLATES CAT. NO 0 019 62/4 018 53

Perforated plates, cat. no 0 019 62 for 12-module cabinets and cat. no 4 018 53 for 18-module cabinets, are used to fix non-modular products. the plate is fitted in place of a modular rail anwidthd its supports in 12/18-module cabinets with more than 2 rows.

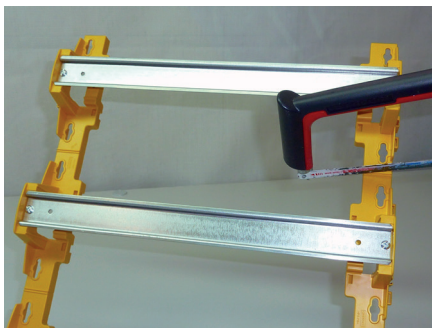

The cabinet chassis has to be cut.



The plate is fixed at the back of the cabinet using the screws provided, or re-using the chassis fixing screws.

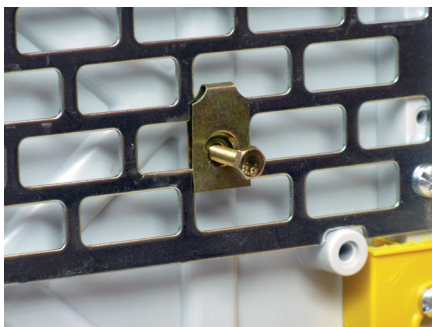

M6 clip nuts cat. no 0 200 96 must be used to fix products on the perforated plate. the usable space between the perforated plate and the solid faceplate is 91 mm.

HINGES CAT.NO 0 019 70

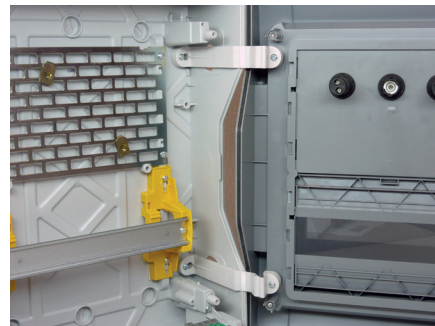

The hinge kit, comprising 2 parts, is used to join the front panel of the Plexo³ cabinet to the back.

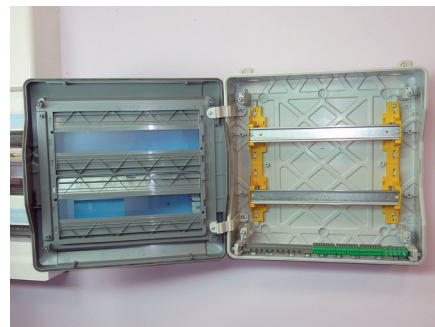

These hinges enable the front panel to be opened to an angle of 180°.

USING THE CABINETS

RUNNING THE CABLES

■ Cable entries

Plexo³ cabinets have identical pre-cut isometric knockouts on the top and bottom for fitting ISO membrane glands or cable glands.

On one of the two surfaces, the 20 mm and 25 mm diameter knockouts are fitted with piercable membrane glands. these membrane glands are removable and can be replaced with the same membrane gland or with a cable gland.



CAT.NOS		NUMBER OF PRE-CUT KNOCKOUTS ON THE TOP			NUMBER OF KNOCKOUTS FITTED WITH PIERCABLE MEMBRANE GLANDS ON THE BOTTOM		
		Ø 20 mm	Ø 25 mm	Ø 32 mm	Ø 20 mm	Ø 25 mm	Ø 32 mm
FRANCE	0 019 02	2	-	-	2*	-	-
	0 019 04	2	1	-	2	1	-
	0 019 06	4	1	-	4	1	-
	0 019 08	6	1	-	6	1	-
	0 019 21	7	2	2	7	2	1*
	0 019 22	13	2	2	13	2	1*
	0 019 23	13	2	2	13	2	1*
	0 019 24	12	2	3	11	2	1*
	0 019 25	13	4	3	13	2	1*
	0 019 26	13	4	3	13	4	1*
0 019 27	13	4	3	13	4	1*	

* Membrane glands not fitted, supplied in the cabinet

CAT.NOS		NUMBER OF PRE-CUT KNOCKOUTS ON THE TOP/BOTTOM		
		Ø 20 mm	Ø 25 mm	Ø 32 mm
EXPORT	6 019 32*	2/2	-	-
	6 019 94	2/2	1/1	-
	6 019 96	4/4	1/1	-
	6 019 98	6/6	1/1	-
	6 018 31	7/7	2/2	2/2
	6 018 32	13/13	2/2	2/2
	6 018 33	13/13	2/2	2/2
	6 018 35	12/12	2/2	3/3
	6 018 36	13/13	4/4	3/3
	6 018 37	13/13	4/4	3/3
	6 018 38	13/13	4/4	3/3

* 2 piercable membrane Ø 20 mm glands not fitted, supplied in the cabinet

■ Fixing the cables



Cabinets with 2 or more rows are supplied with guide rings for keeping the cables tidy.



the cables can also be fixed at the back of the cabinet using colring cable ties up to 7.6 mm.



The 32 mm diameter cut-outs on the sides can also take piercable membrane glands.



It is also possible to mount LINA 25TM duct horizontally and/or vertically.

USING THE CABINETS

MOUNTING MODULAR AND MOULDED CASE PRODUCTS

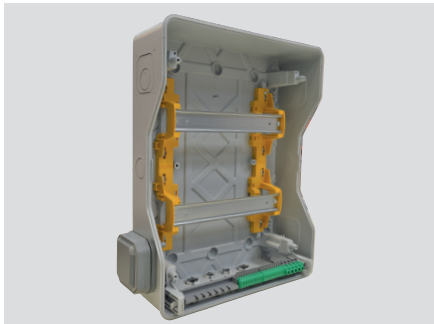

The rails with 2 adjustable depth positions, with a 150 mm space between them, can take DIN rail equipment and DPx³ 160 Mccbs. The maximum amperage of the enclosure must be respected (125A).

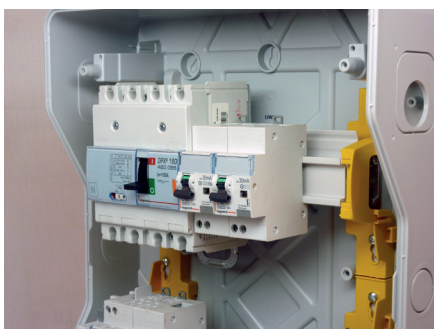

MCCBs and DIN rail equipment can be installed on the same rail using the height spacer cat. no 0 262 99.

ACCESSORIES FOR SLEEVES



Multi-function sleeves are joined to 12 and 18-module cabinets using the joining kit, cat. no 0 019 67 (see page 6).

■ Vertical sleeves have 3 or 4 identical positions.



Each position is equipped with a blanking plate on which two Osmoz control units, or equivalent, can be fixed.



If this blanking plate is removed, a P17 socket industrial up to 32 a with standard fixing centres or Plexo flush-mounting mechanism can be fitted. a rail can be fixed at the back of the cabinet in order to install a terminal block, for example.

■ Horizontal sleeves have 2 or 3 empty positions with no blanking plates.



Each position can take 220 x 125 P17 faceplates, on which 16/32 a and 63 a P17 socket outlets with standard fixing centres can be installed:

- Faceplate cat. no 0 577 12 → P17 - 16 a
- Faceplate cat. no 0 577 13 → P17 - 16 a or 32 a
- Faceplate cat. no 0 577 17 → P17 - 63 a
- Faceplate cat. no 0 577 15 → P17 - 16 a to 63 a after drilling the faceplate

■ A vertical sleeve cat. no 0 019 17 can be joined to a cabinet with 3 rows

- The vertical sleeve used with a 2- row cabinet has 3 positions
- The vertical sleeve used with a 3-row cabinet has 4 positions.
- The horizontal sleeve used with a 12-module cabinet has 2 positions
- The horizontal sleeve used with an 18-module cabinet has 3 positions

DISTRIBUTION SYSTEM

Plexo³ cabinets can take all standard and optimised distribution systems up to 125A, depending on the size of the cabinet.

- Distribution using IP 2 x insulated terminal blocks

an IP 2x terminal block can be fitted in 2 to 8-module Plexo3 cabinets via its lugs and the knockouts in the base of the cabinet. IP 2x insulated terminal blocks can be fixed directly on the rails in the Plexo3 cabinet, or on a 12 x 2 flat bar cat.no 0 048 19.

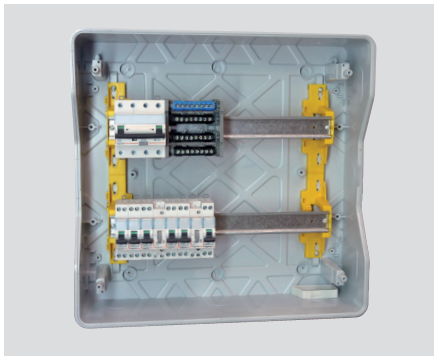

- Modular distribution blocks 40 a to 125 a single pole, 2-pole or 4-pole modular distribution blocks, with insulation voltage up to 500 V, can easily be used in Plexo³ cabinets.



- Single phase horizontal distribution using 63 A HX³ single pole supply busbars for cabinets with 2 to 3 rows (for cabinets with 4 rows, two 2-row supply busbars cat. no 4 050 03 must be used).



Thanks to the automatic terminals doubled on the DNX³ and DX³ uni+neutral circuit-breakers, the connection of the universal prong type supply busbars and accessories is made in a single step, regardless of the organization of the row: circuit-breakers, auxiliaries, controls follow each other in the order of the electrical diagram. The reliability of the connection is total, guaranteed over time: the tests have been validated in accordance with NF EN 60898-1 and EN 60947-2 standards.

- Three-phase horizontal distribution by means of a 4-pole prong type supply busbar HX³ optimized 63 A

With the four-pole "group head" prong type supply busbar and the automatic terminals doubled on the DX³ circuit-breakers, as well as the various adapted accessories, the connection is made with a single movement, whatever the organization of the row: all-polarity circuit-breakers, auxiliaries and controls follow one another in the order of the electrical diagram. The reliability of the connection is total, guaranteed over time: the tests have been validated in accordance with NF EN 60898-1 and EN 60947-2 standards.

- Conventional HX³ prong type busbars for screw terminals

Conventional HX³ busbars (from 2 to 4 poles) can be used to supply a row or a group of modular devices with screw terminals. Only products with 1 module per pole and no auxiliary block can be connected to these busbars.

- Single phase and 4-pole VX³ vertical distribution up to 63 A

- Single phase vertical supply busbars with 150 mm fixing centres and 4 poles integrate perfectly in Plexo³ cabinets. Their optimised dimensions provide more space for quick, reliable distribution from one row to another.

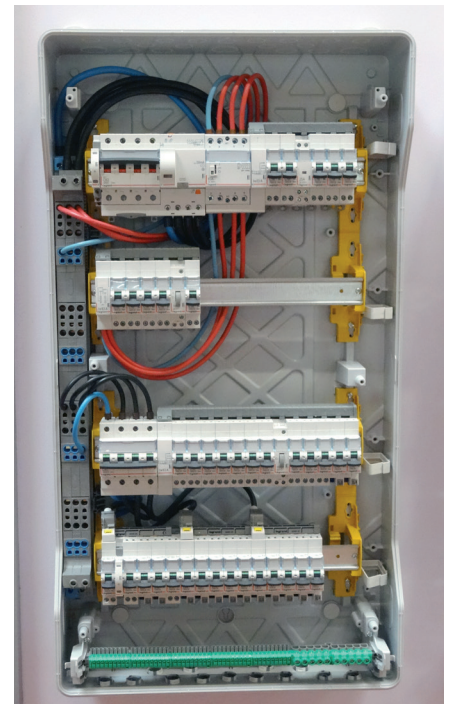

- The 4-pole supply busbar is equipped with automatic output terminals. Distribution is possible via flexible wires, with or without membrane glands. the power supply to this busbar can be provided from the top or the bottom via screw terminals. their dimensions and fixing system provide a maximum amount of space on the modular rails or at the back of the cabinet.

i Working on the 4-pole vertical supply busbar is prohibited when it is energised.

USING THE CABINETS

REMOVABLE CHASSIS AND RAILS

Cabinets with 1 row and 2 to 18 modules have a rail fixed to the structure of the cabinet.

Cabinets with 2, 3 and 4 rows have a removable chassis which enables wiring to be carried out outside the cabinet and makes wall fixing easier. this chassis is removed by loosening the screws and sliding it upwards. the chassis is held on the structure of the cabinet by 4 screws.



i The 4-row cabinet has two 2-rail chassis.

REVERSIBLE DOOR

The doors of 2 to 8-module cabinets have a horizontal axis of rotation and are fitted with a brake which holds the door open. the doors of 12 and 18-module cabinets have a vertical axis of rotation. with an opening angle, more than 180°, the doors provide total access to the cabinet.



The direction of opening of the doors of Plexo³ cabinets can be reversed by turning round the front panel of the cabinet.

MARKING THE FACEPLATES

For cabinets with 2 or more rows, the faceplates have a marking system to make sure they are placed on the correct row.



Copy the number engraved on the back of the faceplate onto the front panel using an indelible marker.

FIXING THE CABINETS

Depending on the location and external constraints, there is a pre-drilled hole on the top and bottom of the cabinets for draining any condensation, according to the location and the external stresses.



■ All Plexo³ cabinets have 2 fixing methods via the inside of the cabinet:

-Fixing via central point: this hanging fixing method ensures that the cabinet is vertical, with 1 centred point at the top and 2 points at the bottom (except for 2 and 4-module cabinets)

-Fixing via 4 adjustable points.

■ 2, 4, 6 et 8-module cabinets

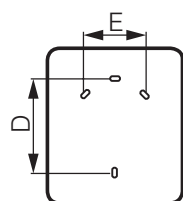

CAT.NOS		DIMENSIONS (mm)	
France	Export	D	E
0 019 02	6 019 32	94	-
0 019 04	6 019 94	120	-
0 019 06	6 019 96	120	70
0 019 08	6 019 98	120	106

■ 12 & 18 cabinets

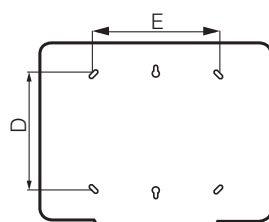

CAT.NOS		DIMENSIONS (mm)	
France	Export	D	E
0 019 21	6 018 31	180	180
0 019 22	6 018 32	330	180
0 019 23	6 018 33	480	180
0 019 24	6 018 35	180	290
0 019 25	6 018 36	330	290
0 019 26	6 018 37	480	290
0 019 27	6 018 38	680	290

The max. screw diameter for each fixing point is 6 mm. All cabinets, apart from cat. no 0 019 02, are supplied with a set of 4 screw caps. Once the cabinet is fixed on the wall, fitting these screw caps maintains the IP protection and class II insulation of the cabinet.



■ External fixing lugs cat. no 0 019 69 can also be used:



For the 2 (+1) module cabinet, the fixing lugs are fitted vertically.



For cabinets with more than 2 modules, and for multi-function sleeves, the lugs can be fitted vertically or horizontally.

FIXING THE CABINETS

■ Joined cabinets

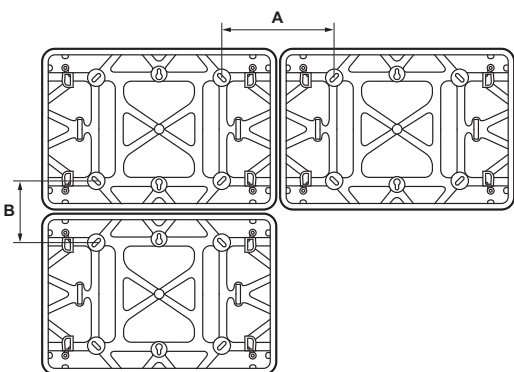

TYPE OF CABINET	HORIZONTAL JOINING				A (mm)
	Cabinet 1	Cabinet 2	Cabinet 1	Cabinet 2	
	France		Export		
1 ROW	0 019 21	0 019 21	6 018 31	6 018 31	164
	0 019 21	0 019 24	6 018 31	6 018 35	164
2 ROWS	0 019 22	0 019 22	6 018 32	6 018 32	164
	0 019 22	0 019 25	6 018 32	6 018 36	164
3 ROWS	0 019 23	0 019 23	6 018 33	6 018 33	164
	0 019 23	0 019 26	6 018 33	6 018 37	164

TYPE OF CABINET	VERTICAL JOINING				B (mm)
	Cabinet 1	Cabinet 2	Cabinet 1	Cabinet 2	
	France		Export		
12 MODULES	0 019 21	0 019 21	6 018 31	6 018 31	108
		0 019 22		6 018 32	108
		0 019 23		6 018 33	128
	0 019 22	0 019 21	6 018 32	6 018 31	108
		0 019 22		6 018 32	108
		0 019 23		6 018 33	128
	0 019 23	0 019 21	6 018 33	6 018 31	128
		0 019 22		6 018 32	128
		0 019 23		6 018 33	148
18 MODULES	0 019 24	0 019 24	6 018 35	6 018 35	108
		0 019 25		6 018 36	108
		0 019 26		6 018 37	128
		0 019 27		6 018 38	128
	0 019 25	0 019 24	6 018 36	6 018 35	108
		0 019 25		6 018 36	108
		0 019 26		6 018 37	128
		0 019 27		6 018 38	128
	0 019 26	0 019 24	6 018 37	6 018 35	128
		0 019 25		6 018 36	128
		0 019 26		6 018 37	148
		0 019 27		6 018 38	149
0 019 27	0 019 24	6 018 38	6 018 35	128	
	0 019 25		6 018 36	128	
	0 019 26		6 018 37	149	
	0 019 27		6 018 38	149	

■ Cabinets with sleeves

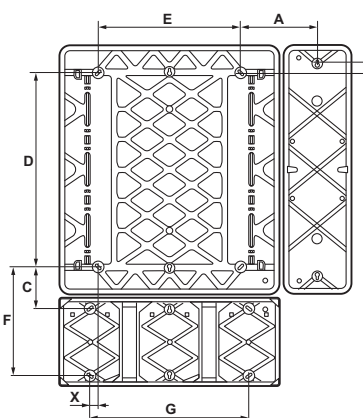

CONFIGURATION	FRANCE		A	B	C	D	E	F	G	X	Y
	France	Export									
2 x 12-module cabinet	0 019 22	6 018 32									
2-row vertical sleeve	0 019 17	0 019 17	155	340	89	330	180	254	215	17	0
12-module horizontal sleeve	0 019 19	0 019 19									
3 x 12-module cabinet	0 019 23	6 018 33									
3-row vertical sleeve	0 019 18	0 019 18	155	340	109	480	180	274	215	17	19
12-module horizontal sleeve	0 019 19	0 019 19									
2 x 18-module cabinet	0 019 25	6 018 36									
2-row vertical sleeve	0 019 17	0 019 17	154	530	89	330	290	254	323	16	0
18-module horizontal sleeve	0 019 20	0 019 20									
3 x 18-module cabinet	0 019 26	6 018 37									
3-row vertical sleeve	0 019 18	0 019 18	154	530	109	480	290	274	323	16	20
18-module horizontal sleeve	0 019 20	0 019 20									
4 x 18-module cabinet	0 019 27	6 018 38									
2-row vertical sleeve	0 019 17	0 019 17	155	530	109	680	290	274	323	16	0
18-module horizontal sleeve	0 019 20	0 019 20									
4 x 18-module cabinet	0 019 27	6 018 38									
3-row vertical sleeve	0 019 18	0 019 18	155	530	109	680	290	274	323	16	20
18-module horizontal sleeve	0 019 20	0 019 20									

fixing using external lugs

■ Cabinets only

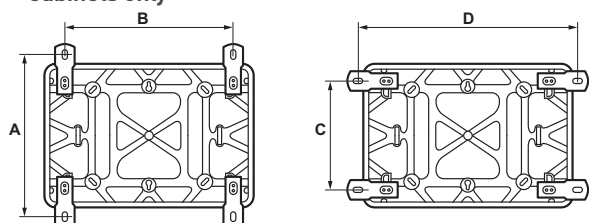

TYPE OF CABINET	CAT.NOS		LUGS FITTED VERTICALLY		LUGS FITTED HORIZONTALLY	
	France	Export	A (mm)	B (mm)	C (mm)	D (mm)
2 + 1-MODULE CABINET	0 019 02	-	192	39	Not possible	
4-MODULE CABINET	0 019 04	-	218	64	132	150
6-MODULE CABINET	0 019 06	-	218	100	132	186
8-MODULE CABINET	0 019 08	-	218	136	132	175
12-MODULE CABINET	0 019 21	6 018 31	301	273	215	357
	0 019 22	6 018 32	450	271	365	357
	0 019 23	6 018 33	640	271	555	357
18-MODULE CABINET	0 019 24	6 018 35	301	379	215	465
	0 019 25	6 018 36	450	379	365	465
	0 019 26	6 018 37	640	379	555	465
	0 019 27	6 018 38	841	379	755	465

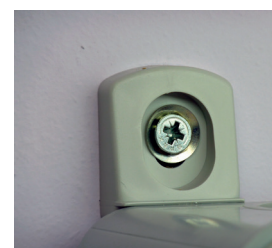

The diameter of the holes for the fixing lug screws is 8 mm.



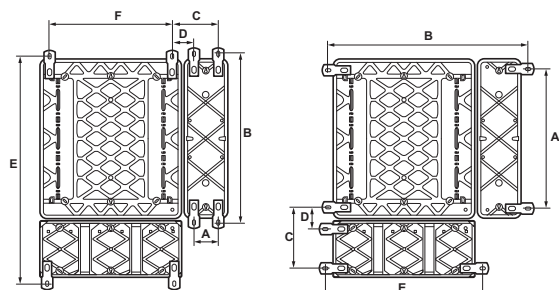



■ Cabinets with sleeves



CONFIGURATION	CAT.NOS		LUGS FITTED VERTICALLY						LUGS FITTED HORIZONTALLY				
	France	Export	A	B	C	D	E	F	A	B	C	D	E
2 x 12-module cabinet	0 019 22	6 018 32											
2-row vertical sleeve	0 019 17	0 019 17	71	452	145	74	684	282	336	502	235	73	368
12-module horizontal sleeve	0 019 19	0 019 19											
3 x 12-module cabinet	0 019 23	6 018 33											
3-row vertical sleeve	0 019 18	0 019 18	71	642	143	72	875	282	556	502	235	73	368
12-module horizontal sleeve	0 019 19	0 019 19											
2 x 18-module cabinet	0 019 25	6 018 36											
2-row vertical sleeve	0 019 17	0 019 17	71	452	145	74	684	390	336	610	235	73	476
18-module horizontal sleeve	0 019 20	0 019 20											
3 x 18-module cabinet	0 019 26	6 018 37											
3-row vertical sleeve	0 019 18	0 019 18	71	642	143	72	875	390	556	611	235	73	476
18-module horizontal sleeve	0 019 20	0 019 20											
4 x 18-module cabinet	0 019 27	6 018 38											
2-row vertical sleeve	0 019 17	0 019 17	71	642	146	75	1075	390	336	611	235	73	476
18-module horizontal sleeve	0 019 20	0 019 20											
4 x 18-module cabinet	0 019 27	6 018 38											
3-row vertical sleeve	0 019 18	0 019 18	71	452	146	75	1075	390	556	611	235	73	476
18-module horizontal sleeve	0 019 20	0 019 20											

SPARE PARTS & ACCESSORIES

CAT.NO	DESCRIPTION	CONTENT
0 016 65	Blanking plate 18 modules	
0 019 55	Direct piercing end caps 2 ISO32 + 5 ISO25 + 10 ISO20	
0 019 56	100 cable glands ISO20	
0 019 57	100 cable glands ISO25	
0 019 58	100 cable glands ISO32	
0 019 61	Blanking plates 5 separable into modules - RAL746A	
0 019 62	Perforated faceplate 12 modules - height 150 mm	
4 018 53	Perforated faceplate 18 modules - height 150 mm	
0 019 64	Plain faceplate 12 modules	
0 019 65	Plain faceplate 18 modules	
0 019 66	Key lock N° 850	
0 019 67	Set of 2 joining kits	
0 019 68	Sealing kit - Set of 2 sealable terminal shields for cover and 8 sealable supports for faceplate	

CAT.NO	DESCRIPTION	CONTENT
0 019 69	Wall mounting lugs (4)	
0 019 70	Set of 2 hinges	
0 019 71	Plexo adaptors - minimum 2 rows	
0 019 72	Supports for terminal block - for 1 & 2 rows/12-18 modules	
0 019 73	Supports for terminal block - for 3 & 4 rows/12-18 modules	
0 048 17	35-holes empty support, for screw terminal blocks Length: 276 mm	
4 048 21	Empty support with 50 holes (length 385 mm) Takes unprotected screw terminal blocks	

To know more, check legrand.com



All technical data of the products inside this workshop specifications book are available on: www.legrand.com/ecatalogue/

Click on **>DOWNLOAD DOCUMENTS**

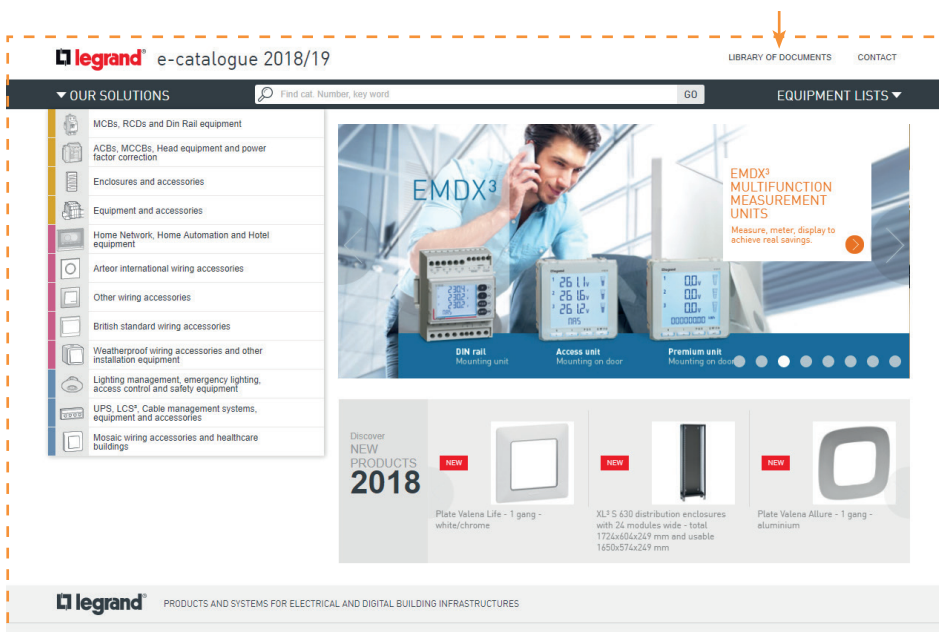



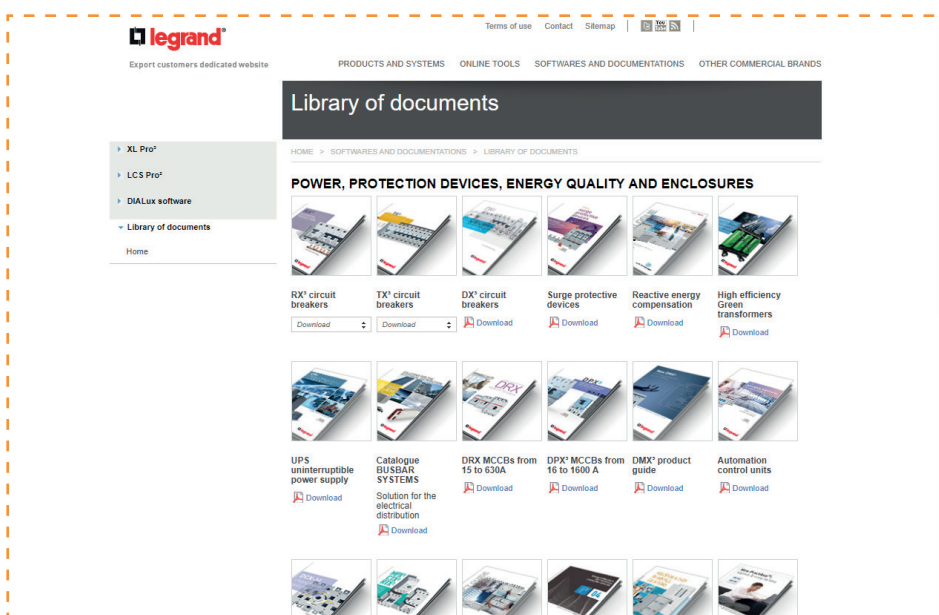

>Library of documents





FOLLOW US ALSO ON

- @ legrand.com
-  youtube.com/user/legrand
-  facebook.com/Legrand
-  twitter.com/Legrand
-  pinterest.com/legrandgroup
-  instagram.com/legrandnews



Head office
and International Department
87045 Limoges Cedex - France
Tel: + 33 (0) 5 55 06 87 87
Fax: + 33 (0) 5 55 06 74 55