



PRE-FILLED WITH GEL

for integrated connections

**Electrical performance:**

CEI EN 50393  
(with testing under water head  
and water between the cable cores)  
Class 2 in accordance with CEI 64-8.

**No flame propagation:**

CEI 20-35 • IEC 60332-1 HD405-1  
(as applicable)  
Low smoke and toxic and  
corrosive gas emissions

Gel: **cRU** **us**

Casing mix: UL 94-V2

Degree of protection: IPX8

Operating temperature **90°**Installation temperature: **-40°C / +50°C****IPX8**  
OFFICIALLY  
TESTED | **IMQ**

# King Joint

Range of fast gel pre-filled straight or branch type joints for 0.6/1 kV multi core cables of up to 5 conductors.

The primary insulation, consisting of a cross-linked polymer gel and extremely strong plastic insulating housing, make the Class 2, in accordance with the definitions contained in CEI Regulation 64-8. The joint, tested in accordance with the most important international specifications with repeated bending and twisting cycles and immersion in water, was found to comply with the mechanical, electrical and sealing requirements necessary for accessories for plastic cables. The joint and its components have no self life, are chemically inert and therefore completely safe; the conductor connections are re-accessible even after long operating periods. Packaged with self-extinguishing material, it is flame retardant. Suitable for cables with a temperature of +90°C.

- For multicore cables of up to 5 cores
- 5 sector spacers for proper centring of five-core connection
- Complete with screw connectors
- For straight and branch connections, including armoured cable
- For all types of application, including submersible
- Re-accessible and with no shelf life
- Flame retardant
- Non toxic and safe

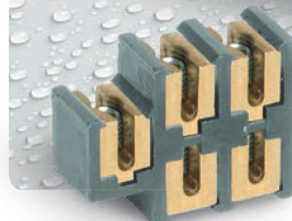
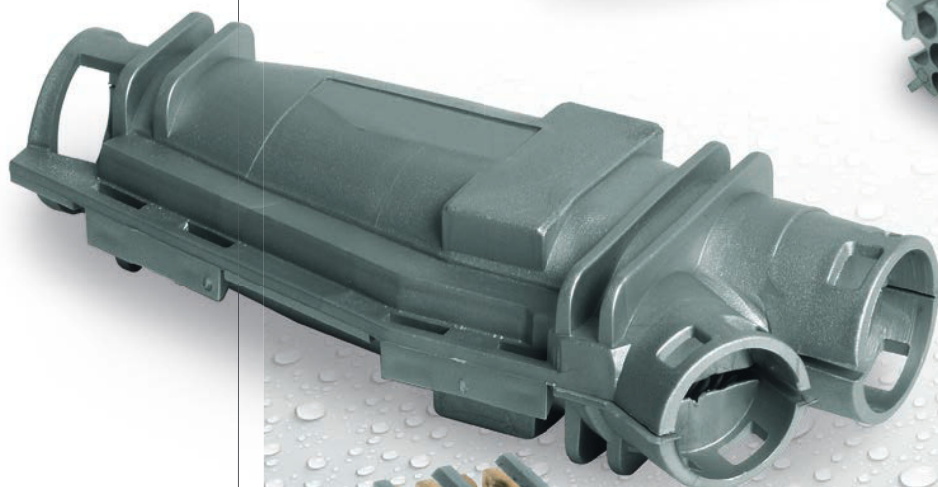
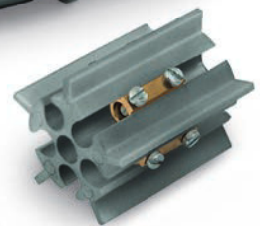



PRE-FILLED WITH GEL

for integrated connections

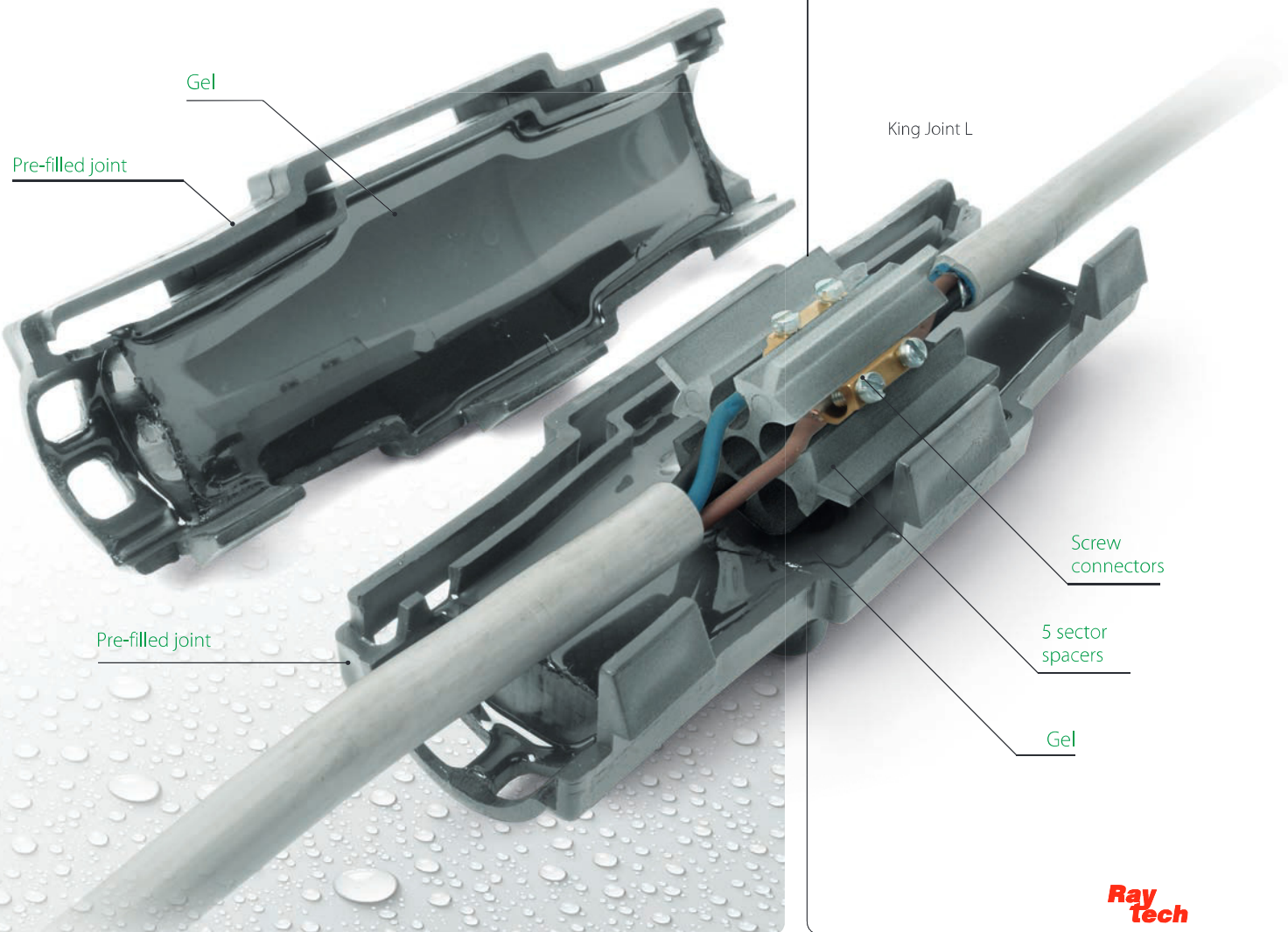
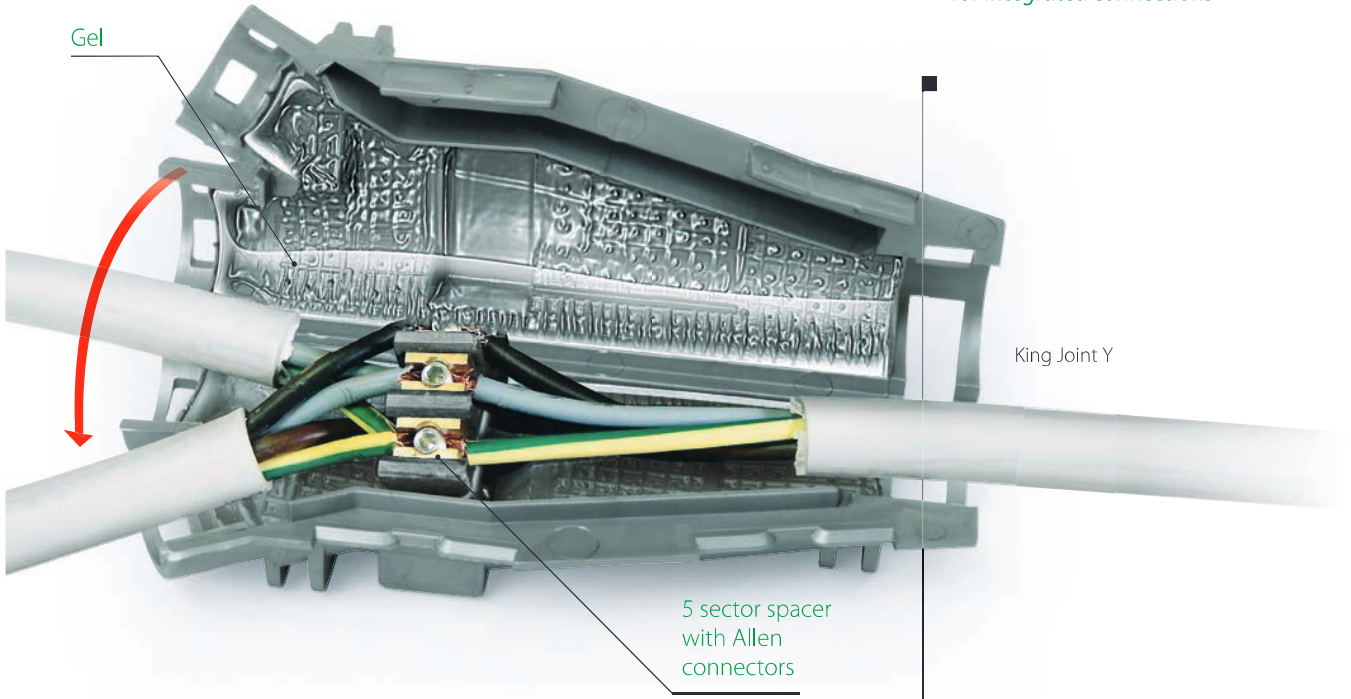



## King Joint L

Straight joints, including armoured cable.

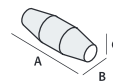

Product	LINE CONNECTIONS Cable formation and conductor cross sections (n° x mm <sup>2</sup> )	∅ max cables (mm)	Dimensions A x B x C (mm)
• King Joint 0 blister	2 x 1,5 - 6	20,5	105 x 55 x 55
	3 x 1,5 - 6		
	4 x 1,5 - 6		
	5 x 1,5 - 6		
• King Joint L6 box	2 x 1,5 - 6	20,5	105 x 55 x 55
	3 x 1,5 - 6		
	4 x 1,5 - 6		
	5 x 1,5 - 6		



Product	STRAIGHT CONNECTIONS Cable formation and conductor cross sections (n° x mm <sup>2</sup> )	∅ max cables (mm)	Dimensions A x B x C (mm)
• King Joint L10 • King Joint L10 - ARM	2 x 2,5 - 10	24	180 x 60 x 60
	3 x 2,5 - 10		
	4 x 2,5 - 10		
	5 x 2,5 - 10		



Product	STRAIGHT CONNECTIONS Cable formation and conductor cross sections (n° x mm <sup>2</sup> )	∅ max cables (mm)	Dimensions A x B x C (mm)
• King Joint L25 • King Joint L25 - ARM	2 x 4 - 25	31	210 x 65 x 65
	3 x 4 - 25		
	4 x 4 - 25		
	5 x 4 - 25		

**ARM** type joints complete with continuity device suitable for connection to **armoured wire or steel tape cables**.

## Installation sequence King Joint L

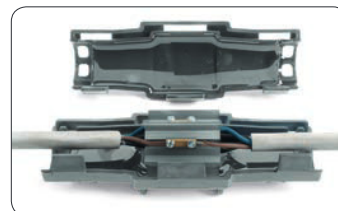
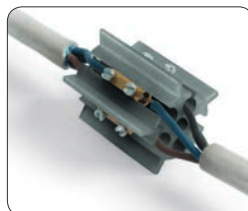





PRE-FILLED WITH GEL  
for integrated connections

# King Joint Y

Branch joints, including armoured cable.

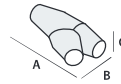

Product	BRANCH CONNECTIONS Cable formation and conductor cross sections (n° x mm <sup>2</sup> )		Ø max cables (mm)		Dimensions A x B x C (mm)
	T	B	T	B	
<ul style="list-style-type: none"> <li>• King Joint Y6</li> <li>• King Joint Y6 - ARM</li> </ul>	2 x 1,5 - 6	2 x 1,5 - 4	22,5	18,5	138 x 60 x 37
	3 x 1,5 - 6	3 x 1,5 - 4			
	4 x 1,5 - 6	4 x 1,5 - 4			
	5 x 1,5 - 6	5 x 1,5 - 4			

T: Through cable - B: Branch cable



Product	BRANCH CONNECTIONS Cable formation and conductor cross sections (n° x mm <sup>2</sup> )		Ø max cables (mm)		Dimensions A x B x C (mm)
	T	B	T	B	
<ul style="list-style-type: none"> <li>• King Joint Y16</li> <li>• King Joint Y16 - ARM</li> </ul>	2 x 4 - 16	2 x 1,5 - 4	26	18,5	194 x 74 x 43
	3 x 4 - 16	3 x 1,5 - 4			
	4 x 4 - 16*	4 x 1,5 - 4			
	5 x 4 - 16*	5 x 1,5 - 4			

T: Through cable - B: Branch cable

\* For armoured cables max conductor cross section 10 mm<sup>2</sup>.



Product	BRANCH CONNECTIONS Cable formation and conductor cross sections (n° x mm <sup>2</sup> )		Ø max cables (mm)		Dimensions A x B x C (mm)
	T	B	T	B	
<ul style="list-style-type: none"> <li>• King Joint Y35</li> <li>• King Joint Y35 - ARM</li> </ul>	2 x 10 - 35	2 x 1,5 - 6	36	26	290 x 105 x 51
	3 x 10 - 35	3 x 1,5 - 6			
	4 x 10 - 35*	4 x 1,5 - 6			

T: Through cable - B: Branch cable

\* For armoured cables max conductor cross section 25 mm<sup>2</sup>.

ARM type joints complete with continuity device suitable for connection to **armoured wire or steel tape cables**.



## Installation sequence King Joint Y

