

378.090.056.20 BADERUMSRENDE WATERLINE 900

- Gulv: beton og fliser
- Ramme: rektangulær
- Udløb: Ø50 mm, lodret
- Rustfrit stål: AISI304/EN1.4301

Produktkoder

EAN: 5705499138160
VVS nummer: 155062009
RSK nummer: 7121694
LVI nummer: 3304417

Specifikation

Betegnelse: 50x900
Gulv: Beton / fliser
Materiale: AISI 304
Materiale (EN): EN 1.4301
Membran: Smøremembran
Ramme: Rektangulær
Sump: Nej
Type: Render
Udløbsdiameter (mm): 50
Udløbsplacering: Ende
Udløbsretning: Lodret

Godkendelser



NO - TG 2484



FI-Tyypihyväksyntä VTT-RTH-03128-08 Blücher
Waterline 275,378-2017

mk DK - MK 7.21/1664-21

va DK - VA 2.44/19499-20

PL - Hygienic Certificate - All products

RU - 0212321 Drains-21

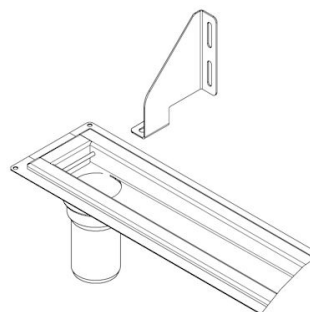
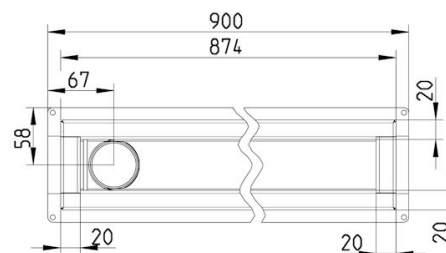
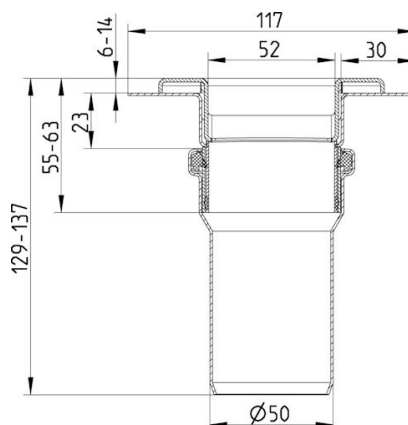

BLÜCHER®