

Opus 66® LED-S 120 VA dimmer with side controller

Operating instructions

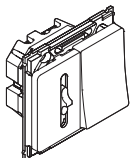

Art. no. 506N5219, 506N6219, 506N8219

For your safety



DANGER

Risk of serious damage to property and personal injury, e.g. from fire or electric shock, due to incorrect electrical installation.

Safe electrical installation can only be ensured if the person in question can prove basic knowledge in the following areas:

- Connecting to installation networks
- Connecting several electrical devices
- Laying electric cables

These skills and experience are normally only possessed by skilled professionals who are trained in the field of electrical installation technology. If these minimum requirements are not met or are disregarded in any way, you will be solely liable for any damage to property or personal injury.



DANGER

Risk of death from electric shock.

The outputs may carry an electrical current even when the device is switched off. Always disconnect the fuse in the incoming circuit from the supply before working on connected loads.

Getting to know the dimmer

With the OPUS 66® Universal LED slide dimmer 260W with side controller (referred to as **dimmer** in the following) you can switch and dim ohmic, inductive or capacitive loads:



LED

Dimmable LED lamps



Incandescent lamps (ohmic load)

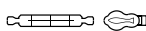

230 V halogen lamps (ohmic load)



Low-voltage halogen lamps with dimmable wound transformer (inductive load)

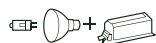

Low-voltage halogen lamps with electronic transformer (capacitive load)

The dimmer automatically recognises the connected load. It is overload-proof, short-circuit-proof and protected from overheating and it has a soft-start function.

You can set the dimming range and adjust the operating mode (from trailing edge phase to leading edge phase).

The dimmer has an integrated side controller input where you can connect mechanical push-buttons only without status LED/lamp. You have the option of switching the dimmer on and off from other places using external push-buttons.



CAUTION

The dimmer may be damaged!

- Always operate the dimmer according to the technical data provided.
- Connected dimmers may be damaged if you connect a combination of loads (inductive and capacitive) at the same time.
- The dimmer is designed for sinusoidal mains voltages.
- If transformers are used, only connect dimmable transformers to the dimmer.
- Dimming socket outlets is prohibited. The risk of overload and connecting unsuitable dimmers is too high.

Installing the dimmer

Wiring the insert

Without side controller

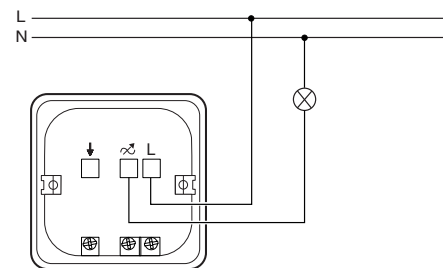

With side controller

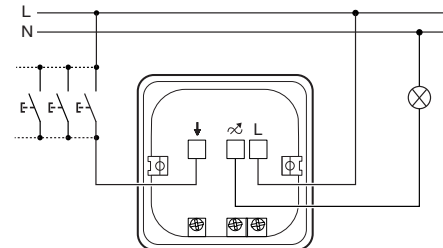

Observe the following:

- Only operate the dimmer using push-buttons without status LED/lamp.
- Only connect push-buttons with a maximum cable length of 50 m.
- Use only the same phase for side controller and power load connection.

Installing the dimmer

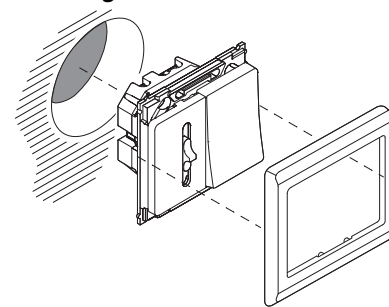

Removing the rocker

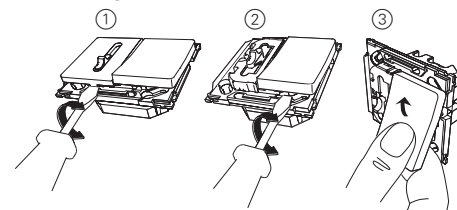

Attaching the rocker

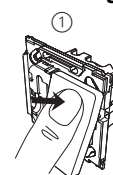

Setting the dimmer

Dimming range

If needed the dimming range of the dimmer can be adapted to the dimming range of lamps from different manufacturers.

Setting the dimming range

i Depending on the dimming range of the lamp, malfunctions may occur for values near the maximum and minimum brightness (refer to the chapter "What should I do if there is a problem?").

i The storable range for the minimum and maximum brightness value is restricted. The minimum brightness value cannot be saved in the high brightness range. The maximum brightness value cannot be saved in the low brightness range.

Setting the minimum brightness value

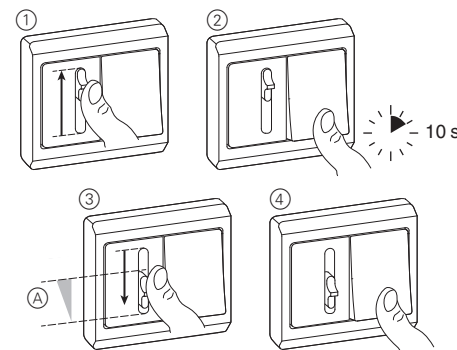

The dimmer is **switched off**.

- 1 Move the dimming slide right to the top
- 2 Hold the push-button down for 10 seconds (the lamp will flash for a short time and then it will be switched on with maximum brightness)
- 3 Move the dimming slide down to the desired minimum brightness (observe storage range A)
- 4 Switch off the dimmer to confirm the selection and end the set mode.

Setting the maximum brightness value

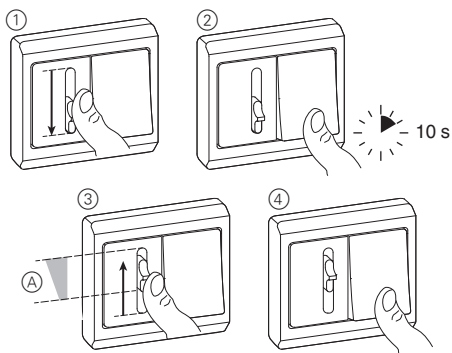

The dimmer is **switched off**.

- ① Move the dimming slide right to the bottom
- ② Hold the push-button down for 10 seconds (the lamp will flash for a short time and then it will be switched on with minimum brightness)
- ③ Move the dimming slide up to the desired maximum brightness (observe storage range A)
- ④ Switch off the dimmer to confirm the selection and end the set mode.

Operating mode

The default setting of the dimmer is the RC mode. The dimmer recognises the connected load automatically, however this can lead to malfunctions in some lamps (see manufacturer's specifications). In this case you can adjust the operating mode.

Switching the operating mode to RL LED mode

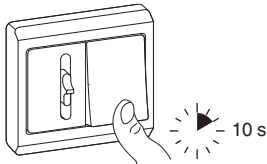

The dimmer is **switched off**.

- ① Move the dimming slide to the middle
- ② Hold the push-button down for 10 seconds (the lamp will flash for a short moment)

The operating mode is switched to "leading edge phase for LED lamps" (RL LED mode) and the minimum/maximum brightness value is reset.

i In the operating mode "leading edge phase for LED lamps" (RL LED mode), the permissible dimmer load for LED lamps is lower (refer to the chapter "Technical data").

Operate the dimmer

Switching load on/off

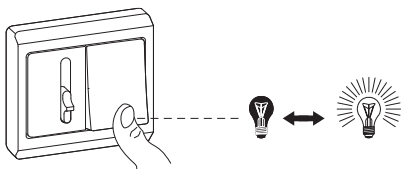

Dimming the load

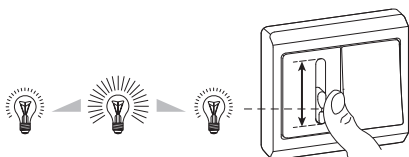

Resetting to default mode

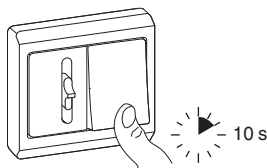

The dimmer is **switched on**.

- ① Move the dimming slide to the middle
- ② Hold the push-button down for 10 seconds (the lamp will flash for a short moment)

The operating mode is switched to "trailing edge phase" (RC mode) and the minimum/maximum brightness value is reset.

Operate the dimmer using side controller

Switching load on/off

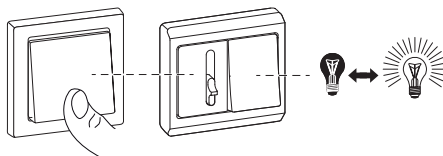

What should I do if there is a problem?

The dimmer dims down regularly during operation and cannot be dimmed up again.

- Allow the dimmer to cool down and reduce the connected load.

The load cannot be switched back on.

- Allow the dimmer to cool down and reduce the connected load.
- Rectify any possible short circuits.
- Renew defective loads.

The load is dimmed to the minimum brightness.

- The circuit is overloaded. -> Reduce load.
- The circuit falls short of the minimum load. -> Increase load.
- Dimming range is incorrect. -> Reduce maximum brightness value.

The load flickers at minimum brightness.

The circuit falls short of the minimum possible brightness value.

- Increase minimum brightness value (set dimming range).

The load flickers continuously.

Incorrect operating mode set.

- Switch operating mode to "leading edge phase for LED lamps" (RL LED mode).
- Alternatively, reset operating mode to default.

The load can only be dimmed slightly.

- Set dimming range.
- Switch operating mode to "leading edge phase for LED lamps" (RL LED mode).

Technical data

Nominal voltage:	AC 230 V ~, 50 Hz
Switching capacity:	
LED lamps	
(RC mode):	4-120 VA
LED lamps	
(RL LED mode):	4-26 VA
Incandescent lamps:	5-230 W
230 V halogen lamps:	5-230 W
LV halogen lamps with dimmable	
wound transformer:	5-230 VA
LV halogen lamps with electronic	
transformer:	5-230 VA
Neutral conductor:	not required
Connecting terminals:	Screw terminals for max. 2x 1.5 mm ²

Side controller:

 Connection: mechanical push-button without status LED/lamp

 Number: any

 Cable length: ≤ 50 m

Protection: max. 13 A circuit breaker

Properties:

- Short-circuit-proof
- Overload-proof
- Soft-start function
- Resistant to overheating
- Automatic load detection

Dimmer tool



Schneider Electric has tested numerous dimmable LED lamps. The dimmer tool provides information on dimmable lamps and the minimum and maximum number of individual lamp models.

Address:

<http://lk.dk/dimmertool>



Dispose of the device separately from household waste at an official collection point. Professional recycling protects people and the environment against potential negative effects.

Lauritz Knudsen

Schneider Electric Danmark A/S · Lautrupvang 1 · 2750 Ballerup · Phone 88 30 20 00 · www.lk.dk