



ULEFOS  
CAPPELEN GROUP

# Rörkopplingar Serie 1

KOMPLETT SORTIMENT MED TILLBEHÖR



# ULEFOS Serie 1 kopplingar för PE-rör

PLASSON HAR I DRYGT 40 ÅR varit en världsledande tillverkare av högkvalitativa plastrördelar. Tillverkaren är certifierad enligt kvalitetssäkringssystemet ISO 9001.

Serie 1 är inte bara vackert formgiven. Den är också liten, smidig och enkel att montera. Dessutom har Serie 1 egenskaper som gör att den med marginal tillgodoser alla de högt ställda krav som ställs på dagens moderna trycksatta vatten- och avloppssystem av polyeten (PE).

- Användningsområdet är vattenledningar av PE, dimension 20-63 mm, samt övergångskoppling till koppar, PB- och PEX-rör.
- Klarar upp till 16 bars arbetstryck (max 20°C).
- Kopplingarna är dragfasta. Serie 1 har en ny patenterad konstruktion, med dubbla greppringar, för ökad säkerhet. En direktverkande greppring samt en konisk, progressiv greppring som ökar greppet på ledningen ju större dragkraften blir.
- Monteringen är extremt enkel. Ingen åtdragning behövs. Avgrada röret och för in det i kopplingen. När röret når rörstoppet är kopplingen helt tät och dragfast!
- Serie 1 har inga lösa delar som gör monteringen osäker.
- Den estetiska och kompakta utformningen gör Serie 1 utmärkt att använda även i synliga installationer samt i begränsade utrymmen.
- Serie 1 är helt korrosionsfri.
- Varje koppling ligger i en skyddande plastpåse med monteringsanvisning.
- Kopplingarna är konstruerade för minst 50 års livslängd.

## TEKNISK DATA

### Material

Hus:	Polypropen (PP)
Mutter:	PP
Greppring:	Polyacetal (POM)
Packning:	Nitrilgummi (NBR)

### Gångor

Alla gångor enligt ISO-7/1. Utvändiga gångor är koniska.

### Standarder

Rördelssortimentet är konstruerat, testat och kontrollerat enligt Plassons interna normer. Dessa normer uppfyller de internationella standarderna ISO 14236, 3458, 3459 och 3501.



# Ulefos Rörkopplingar

## SERIE 1 PN16 FÖR PE-RÖR

### Rak koppling

Typ 1001  
PE - PE

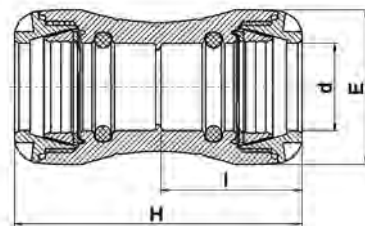

RSK-nr	Art-nr	d mm	E mm	H mm	I mm	Vikt gram/st	Förpackning st Kartong
250 71 52	P1001-020	20	41	92	45	60	260
250 71 53	P1001-025	25	47	98	48	80	200/50
250 71 54	P1001-032	32	58	108	53	130	120/30
250 71 55	P1001-040	40	70	142	70	260	90
250 71 56	P1001-050	50	85	158	78	370	55
250 71 57	P1001-063	63	103	183	90	620	30

### Rak koppling, förminskning

Typ 1011  
PE - PE

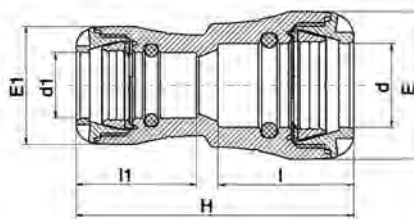

RSK-nr	Art-nr	d x d1 mm	E mm	H mm	I mm	E1 mm	I1 mm	Vikt gram/st	Förpackning st Kartong
250 71 58	P1011-025020	25 x 20	47	100	48	41	45	80	200/50
250 71 59	P1011-032020	32 x 20	58	106	54	41	45	100	160/40
250 71 60	P1011-032025	32 x 25	58	110	54	47	48	110	160/40
250 71 93	P1011-040032	40 x 32	70	139	71	58	55	196	100
250 71 94	P1011-050025	50 x 25	85	151	79	47	46	262	80
250 71 95	P1011-050032	50 x 32	85	151	79	58	55	285	75
250 71 96	P1011-050040	50 x 40	85	151	79	70	72	326	65
250 71 97	P1011-063032	63 x 32	103	170	91	58	55	450	45
250 71 98	P1011-063040	63 x 40	103	184	91	70	72	485	40
250 71 99	P1011-063050	63 x 50	103	187	91	85	81	542	35

### Rak koppling

Typ 1002  
PE - utvändig gänga

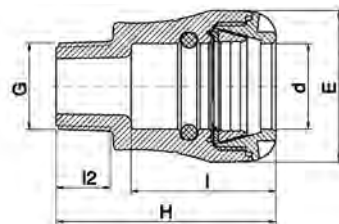

RSK-nr	Art-nr	d x G mm	E mm	H mm	I mm	I2 mm	Vikt gram/st	Förpackning st Kartong
250 71 61	P1002-020015	20 x R15	41	70	45	17	40	340
250 71 62	P1002-020020	20 x R20	41	71	45	18	40	300
250 71 63	P1002-025015	25 x R15	47	75	48	17	50	300/75
250 71 64	P1002-025020	25 x R20	46	76	48	18	50	280/70
250 71 65	P1002-025025	25 x R25	46	78	48	19	60	260/65
250 71 66	P1002-032020	32 x R20	58	82	55	18	80	200/50
250 71 67	P1002-032025	32 x R25	58	84	55	19	90	200/50
250 71 69	P1002-032032	32 x R32	58	86	55	20	90	200/50
250 71 89	P1002-032040	32 x R40	58	86	55	21	90	200/50
250 71 70	P1002-040025	40 x R25	70	104	73	19	150	140
250 71 71	P1002-040032	40 x R32	70	106	73	20	150	135
250 71 72	P1002-040040	40 x R40	70	106	73	21	150	130
250 72 23	P1002-050025	50xR25	85	125	78	19	240	90
250 72 24	P1002-050032	50xR32	85	122	78	21	230	90
250 71 73	P1002-050040	50 x R40	85	114	81	21	230	90
250 71 74	P1002-050050	50 x R50	85	118	81	25	230	85
250 71 75	P1002-063040	63 x R40	103	125	92	21	380	50
250 71 77	P1002-063050	63 x R50	103	129	92	25	370	50

# Ulefos Rörkopplingar

## SERIE 1 PN16 FÖR PE-RÖR

### Rak koppling

Typ 1072

PE - utvändig gänga av mässing

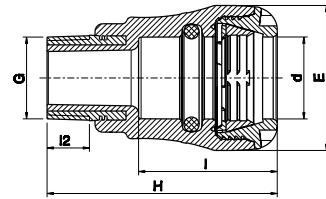

RSK-nr	Art-nr	d x G mm	E mm	H mm	I mm	l2 mm	Vikt gram/st	Förpackning st Kartong
250 72 43	P1072-020015	20 x R15	41	76	45	13	70	340
250 72 44	P1072-020020	20 x R20	41	77	45	15	80	300
250 72 45	P1072-025015	25 x R15	47	79	48	13	80	280/70
250 72 46	P1072-025020	25 x R20	47	80	48	15	90	280/70
250 72 47	P1072-025025	25 x R25	47	85	48	17	136	240/60
250 72 48	P1072-032020	32 x R20	58	88	55	15	120	200/50
250 72 49	P1072-032025	32 x R25	58	92	55	17	150	160/40
250 72 50	P1072-032032	32 x R32	58	100	55	19	200	140/35
250 72 58	P1072-032040	32 x R40	58	101	55	19	239	120
250 72 51	P1072-040025	40 x R25	70	110	73	17	210	130
250 72 52	P1072-040032	40 x R32	70	113	73	19	260	110
250 72 53	P1072-040040	40 x R40	70	113	73	19	290	100
250 72 54	P1072-050040	50 x R40	85	120	81	19	370	80
250 72 55	P1072-050050	50 x R50	85	127	81	23	450	65
250 72 56	P1072-063040	63 x R40	103	132	92	19	500	50
250 72 57	P1072-063050	63 x R50	103	139	92	23	580	50

### Rak koppling

Typ 1003

PE - invändig gänga

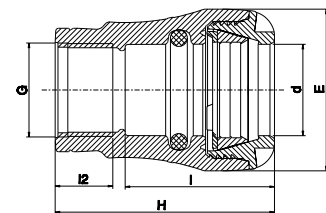

RSK-nr	Art-nr	d x G mm	E mm	H mm	I mm	l2 mm	Vikt gram/st	Förpackning st Kartong
250 72 27	P1003-020015	20 x G15	41	67	45	17	40	340
250 72 28	P1003-020020	20 x G20	41	71	45	18	50	320
250 72 29	P1003-025015	25 x G15	47	70	48	17	50	300/75
250 72 30	P1003-025020	25 x G20	47	71	48	18	50	280/70
250 72 31	P1003-025025	25 x G25	47	80	48	21	60	280/70
250 72 32	P1003-032020	32 x G20	58	77	54	18	80	200/50
250 72 33	P1003-032025	32 x G25	58	79	54	21	80	200/50
250 72 34	P1003-032032	32 x G32	58	90	54	24	110	160/40
250 72 35	P1003-040025	40 x G25	70	97	70	21	150	140
250 72 36	P1003-040032	40 x G32	70	100	70	24	170	135
250 72 37	P1003-040040	40 x G40	70	103	70	24	170	130
250 71 90	P1003-050032	50 x G32	85	110	78	24	240	90
250 72 38	P1003-050040	50 x G40	85	110	78	24	250	90
250 72 39	P1003-050050	50 x G50	85	118	78	29	250	80
250 72 40	P1003-063040	63 x G40	103	125	90	24	380	50
250 72 41	P1003-063050	63 x G50	103	129	90	29	380	45

### Rak övergångskoppling

Typ 1001C

PE - kopparrör

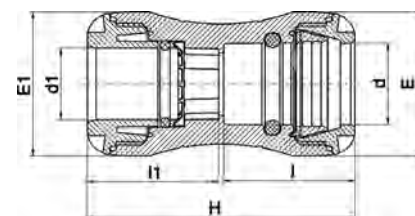

RSK-nr	Art-nr	d x d1 mm	E mm	H mm	I mm	E1 mm	l1 mm	Vikt gram/st	Förpackning st Kartong
250 71 85	P1001C-020015	20 x 15	41	92	45	41	46	70	260
250 71 86	P1001C-025015	25 x 15	47	100	48	41	46	70	200/60
250 71 87	P1001C-025022	25 x 22	47	98	48	47	48	80	180/45
250 71 88	P1001C-032028	32 x 28	58	108	53	58	53	130	120/30
250 71 91	P1001C-040028	40x28	70	139	71	58	55	203	120

# Ulefos Rörkopplingar

## SERIE 1 PN16 FÖR PE-RÖR

### Rak koppling

Typ 1073

PE - invändig gänga av mässing

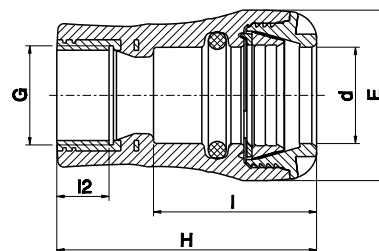

RSK-nr	Art-nr	d x G mm	E mm	H mm	I mm	I2 mm	Vikt gram/st	Förpackning st Kartong
250 73 42	P1073-020015	20 x G15	41	73	45	15	80	300
250 73 43	P1073-020020	20 x G20	41	80	45	16	100	280
250 73 44	P1073-025015	25 x G15	47	76	48	15	90	280/70
250 73 45	P1073-025020	25 x G20	47	78	48	16	100	280/70
250 73 46	P1073-025025	25 x G25	47	89	48	19	140	200/50
250 73 47	P1073-032020	32 x G20	58	86	56	16	140	180/45
250 73 48	P1073-032025	32 x 25	58	88	56	19	160	160/40
250 73 49	P1073-032032	32 x G32	58	98	56	21	210	120/30
250 73 50	P1073-040025	40 x G25	70	106	73	19	230	130
250 73 51	P1073-040032	40 x G32	70	109	73	21	270	110
250 73 52	P1073-040040	40 x G40	70	113	73	21	300	100
250 73 53	P1073-050040	50 x G40	85	118	81	21	370	80
250 73 54	P1073-050050	50 x G50	85	127	81	26	460	65
250 73 55	P1073-063040	63 x G40	103	128	92	21	520	50
250 73 56	P1073-063050	63 x G50	103	133	92	26	590	50

### Ändhuv

Typ 1012

PE

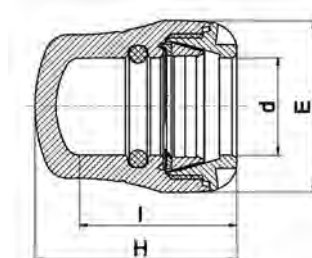

RSK-nr	Art-nr	d mm	E mm	H mm	I mm	Vikt gram/st	Förpackning st Kartong
250 71 45	P1012-020	20	41	56	45	40	360
250 71 46	P1012-025	25	47	60	48	50	300/75
250 71 47	P1012-032	32	58	68	53	80	220/55
250 71 48	P1012-040	40	70	90	71	150	150
250 71 49	P1012-050	50	85	102	79	230	100
250 71 51	P1012-063	63	103	117	91	380	55

### Vinkel 90°

Typ 1005

PE - PE

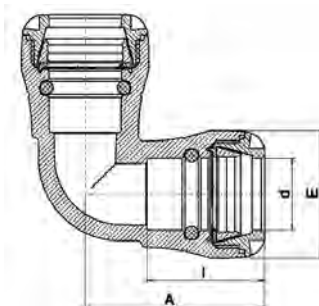

RSK-nr	Art-nr	d mm	E mm	A mm	I mm	Vikt gram/st	Förpackning st Kartong
250 72 01	P1005-020	20	41	67	45	70	200
250 72 02	P1005-025	25	47	73	48	100	160/40
250 72 03	P1005-032	32	58	81	54	160	100/25
250 72 04	P1005-040	40	70	106	70	290	65
250 72 05	P1005-050	50	85	119	78	460	40
250 72 06	P1005-063	63	103	141	90	800	25

# Ulefos Rörkopplingar

## SERIE 1 PN16 FÖR PE-RÖR

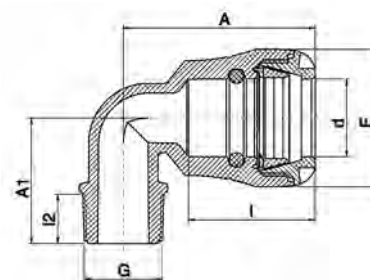

### Vinkel 90°

Typ 1085

PE - utvändig gänga

RSK-nr	Art-nr	d x G mm	E mm	A mm	I mm	A1 mm	I2 mm	Vikt gram/st	Förpackning st Kartong
250 72 07	P1085-020015	20 x R15	41	66	45	41	17	50	300
250 72 08	P1085-020020	20 x R20	41	66	45	42	18	50	300
250 72 09	P1085-025015	25 x R15	47	74	48	44	17	60	280/70
250 72 10	P1085-025020	25 x R20	47	73	47	45	18	60	240/60
250 72 11	P1085-025025	25 x R25	47	73	47	47	19	70	220/55
250 72 12	P1085-032020	32 x R20	58	81	53	51	18	90	180/45
250 72 13	P1085-032025	32 x R25	58	81	53	53	19	90	180/45
250 72 14	P1085-032032	32 x R32	58	81	53	54	20	110	140/35
250 73 83	P1085-040025	40 x R25	70	104	71	59	19	170	110
250 73 84	P1085-040032	40 x R32	70	104	71	60	21	190	100
250 73 85	P1085-040040	40 x R40	70	104	71	64	21	190	100
250 73 86	P1085-050040	50 x R40	85	116	79	69	21	290	65
250 73 88	P1085-063040	63 x R40	103	134	90	78	21	490	
250 73 89	P1085-063050	63 x R50	103	134	90	82	25	490	40

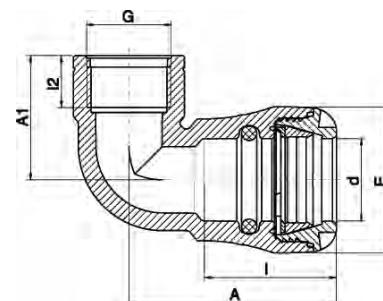

### Vinkel 90°

Typ 1015

PE - invändig gänga

RSK-nr	Art-nr	d x G mm	E mm	A mm	I mm	A1 mm	I2 mm	Vikt gram/st	Förpackning st Kartong
250 73 91	P1015-020015	20 x G15	41	67	45	39	17	50	240
250 73 92	P1015-020020	20 x G20	41	67	45	43	18	50	240
250 74 09	P1015-020025	20 x G25	41	67	45	40	18	60	240
250 73 93	P1015-025015	25 x G15	41	67	45	49	21	60	220/55
250 73 94	P1015-025020	25 x G20	47	74	48	40	17	70	200/50
250 73 95	P1015-025025	25 x G25	47	74	48	43	18	80	180/45
250 73 96	P1015-032020	32 x G20	47	74	48	50	21	100	180/45
250 73 97	P1015-032025	32 x G25	58	83	54	45	18	110	160/40
250 73 98	P1015-032032	32 x G32	58	83	54	49	21	150	120/30
250 73 99	P1015-040025	40 x G25	58	83	54	60	24		110
250 74 00	P1015-040032	40 x G32	70	107	72	51	21		100
250 74 01	P1015-040040	40 x G40	70	107	72	61	24		90
250 74 02	P1015-050040	50 x G40	70	107	72	65	24		60
250 74 03	P1015-050050	50 x G50	85	119	79	63	24		55
250 74 05	P1015-063050	63 x G50	103	141	90	70	29	534	35



# Ulefos Rörkopplingar

## SERIE 1 PN16 FÖR PE-RÖR

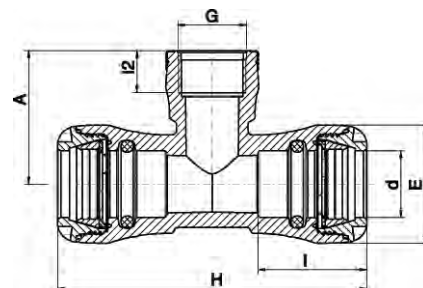

### T-rör

Typ 1014

PE - invändigt gängat avstick - PE

RSK-nr	Art-nr	d x G x d mm x inv. x mm	E mm	H mm	I mm	I2 mm	A mm	Vikt gram/st	Förpackning st Kartong
250 72 15	P1014-020015	20 x G15 x 20	41	67	45	39	17	80	200
250 72 16	P1014-020020	20 x G20 x 20	41	67	45	43	18	90	180
250 72 17	P1014-025015	25 x G15 x 25	41	67	45	49	21	110	140/35
250 72 18	P1014-025020	25 x G20 x 25	47	74	48	40	17	110	140/35
250 72 19	P1014-025025	25 x G25 x 25	47	74	48	43	18	110	140/35
250 72 20	P1014-032020	32 x G20 x 32	47	74	48	50	21	170	80
250 72 21	P1014-032025	32 x G25 x 32	58	83	54	45	18	170	80
250 72 22	P1014-032032	32 x G32 x 32	58	83	54	49	21	220	60

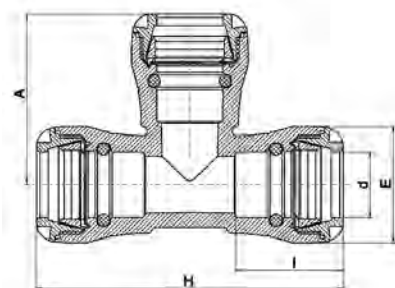

### T-rör

Typ 1004

PE - PE - PE

RSK-nr	Art-nr	d mm	E mm	H mm	A mm	I mm	Vikt gram/st	Förpackning st Kartong
250 71 78	P1004-020	20	41	123	71	45	100	140
250 71 79	P1004-025	25	47	134	78	48	140	100/25
250 71 80	P1004-032	32	58	152	84	54	220	60/15
250 71 81	P1004-040	40	70	192	108	70	430	45
250 71 82	P1004-050	50	85	214	124	78	670	30
250 71 83	P1004-063	63	103	262	147	90	1160	14

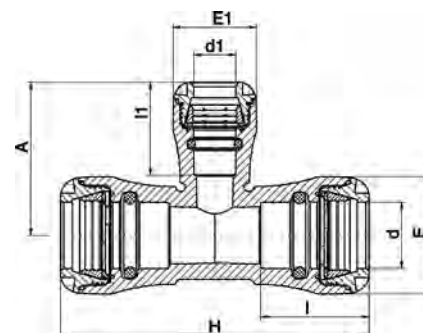

### T-rör

Typ 1034

Förminskat avstick

PE - PE - PE

RSK-nr	Art-nr	d x d1 x d mm	E mm	H mm	I mm	E1 mm	I1 mm	A mm	Vikt gram/st	Förpackning st Kartong
250 72 59	P1034-025020	25 x 20 x 25	47	134	48	41	46	73	127	120
250 72 60	P1034-032020	32 x 20 x 32	58	152	54	41	46	75	185	80
250 72 61	P1034-032025	32 x 25 x 32	58	152	54	47	49	81	195	80
	P1034-040032	40 x 32 x 40	85	214	78		49		360	55
249 35 01	P1034-050032	50 x 32 x 50	85	214	78		54		360	55
	P1034-063032	63 x 32 x 63	103	262	60		54		360	55

# Ulefos Rörkopplingar

## SERIE 1 PN16 FÖR PE-RÖR

### Rak övergångskoppling, universaladapter

TYP 1017

PE- kopparrör, stålrör

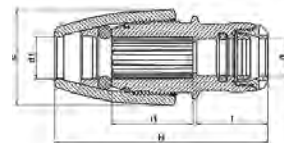

RSK-nr	Art-nr	d mm	H mm	E mm	I mm	I1 mm	Vikt gram/st	Förpackning st Kartong
245 10 81		25x14-18	117-137	54	48	47	130	180
245 11 26		25x19-22	119-130	57	48	47	141	150
245 11 27		25x24-28	130-142	66	48	55	180	120
245 11 29		25x31-35	150-158	76	48	62	235	

### Rak koppling universal, skjutbar

TYP 1761

PE, kopparrör, stålrör

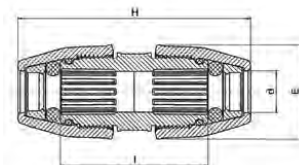

RSK-nr	Art-nr	d mm	H mm	E mm	I mm	Vikt gram/st	Förpackning st Kartong
245 08 03		24-28	200	66	133	345	56
245 08 04		31-35	210	76	143	467	40
245 08 05		40-43	250	89	151	717	30
245 08 06		48-51	270	101	158	968	20
245 08 08		60-64	310	120	176	1517	10

### Verktyg för demontage

Typ 1099

Endast till Serie 1



RSK-nr	Art-nr	d mm	Vikt gram/st	Förpackning st Kartong
250 63 96	P1099-032	20-32	60	300
250 63 97	P1099-063	40-63	290	100

### PVC Adapter kit

Typ 1091Q

För PVC-rör

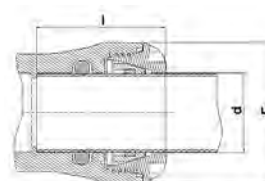

RSK-nr	Art-nr	d mm	E mm	I mm	Vikt gram/st	Förpackning st Kartong
249 14 23	P1091Q-025	25	47	48	26	500
249 14 24	P1091Q-032	32	58	53	31	400
249 14 25	P1091Q-040	40	70	70	56	300
249 14 26	P1091Q-050	50	85	78	72	200
249 14 27	P1091Q-063	63	103	90	134	130

### Fasverktyg

Typ 7960

För PE-rör



RSK-nr	Art-nr	Dy	Vikt gram/st	Förpackning st påse/kartong
250 44 83	P7960-063*	20-63	202	/64
	P7960-063P**	20-63	202	/64