

INSTALLATION MANUAL

MONTAGEANLEITUNG
INSTRUCTIONS DE MONTAGE
ISTRUZIONI PER IL MONTAGGIO

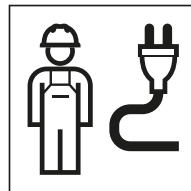

971.471.00.0(00)

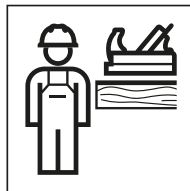
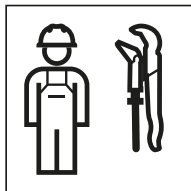



GEFAHR

Elektrischer Schlag

Unsachgemässe Installation kann zu schweren Verletzungen oder zum Tod führen.

- ▶ Elektroanschluss darf nur durch ausgebildete Elektrofachkraft durchgeführt werden.
- ▶ Vor dem Anschliessen der Kabel Stromversorgung unterbrechen.
- ▶ Installation ausschliesslich innerhalb definierter Schutzbereiche vornehmen und geeignete Schutzmassnahmen treffen.



DANGER

Electric shock

Incorrect installation can lead to death or serious injuries.

- ▶ Only trained electrically skilled persons are permitted to set up the electrical connection.
- ▶ Disconnect the power supply before connecting the cables.
- ▶ Only carry out the installation within the defined protective areas and take the appropriate safety measures.



DANGER

Décharge électrique

Une installation incorrecte peut entraîner des blessures graves, voire la mort.

- ▶ Le raccordement électrique ne doit être réalisé que par une personne qualifiée en électricité.
- ▶ Avant de raccorder les câbles, couper l'alimentation électrique.
- ▶ Réaliser l'installation uniquement à l'intérieur des périmètres de protection définis et prendre des mesures de protection adaptées.



PERICOLO

Scossa elettrica

Un'installazione non appropriata può provocare gravi lesioni o la morte.

- ▶ L'allacciamento elettrico deve essere effettuato solo da un elettricista qualificato.
- ▶ Prima di collegare i cavi, interrompere l'alimentazione elettrica.
- ▶ Effettuare l'installazione solo all'interno di perimetri di protezione definiti e adottare delle misure di protezione idonee.



GEVAAR

Elektrisch schok

Ondeskundige installatie kan ernstig letsel en de dood tot gevolg hebben.

- ▶ De elektrische aansluiting mag alleen worden uitgevoerd door een opgeleide elektricien.
- ▶ Voor het aansluiten van de elektriciteitskabels stroomvoorziening onderbreken.
- ▶ Installatie uitsluitend binnen gedefinieerde beschermingszones uitvoeren en geschikte beschermingsmaatregelen treffen.



PELIGRO

Descarga eléctrica

Una instalación inadecuada puede causar lesiones graves o la muerte.

- ▶ La conexión eléctrica únicamente puede realizarla una persona cualificada eléctricamente con la debida formación.
- ▶ Antes de conectar el cable, desconectar la alimentación.
- ▶ Realizar la instalación únicamente en la zona de protección especificada y tomar las medidas de protección necesarias.



PERIGO

Choque eléctrico

A instalação incorreta pode causar ferimentos graves ou levar à morte.

- ▶ A ligação elétrica só pode ser efetuada por uma pessoa eletricamente qualificada.
- ▶ Antes de ligar o cabo, interromper a distribuição de corrente.
- ▶ Efetuar a instalação exclusivamente dentro das áreas de proteção definidas e tomar medidas de proteção adequadas.



FARE

Elektrisk stød

Forkert installation kan føre til alvorlige kvæstelser eller døden.

- ▶ Eltilslutning må udelukkende udføres af en autoriseret elinstallatør.
- ▶ Afbryd strømforsyningen, inden kablerne tilsluttes.
- ▶ Foretag udelukkende installationen inden for definerede beskyttelsesområder, og træf egnede beskyttelsesforanstaltninger.



FARE

Elektrisk stöt

Feil installasjon kan føre til alvorlige personskader eller til dødsfall.

- ▶ Elektrotilkopling må bare utføres av faglært elektriker.
- ▶ Skill strømforsyningen før tilkobling av kablene.
- ▶ Utfør installasjon bare innenfor definerte beskyttelsesområder, og treff egnede beskyttelsestiltak.



FARA

Elektrisk stöt

Felaktig installation kan leda till allvarliga personskador eller dödsfall.

- ▶ Elanslutning får endast genomföras av utbildade, behöriga elektriker.
- ▶ Koppla från strömförsörjningen innan du ansluter kablarna.
- ▶ Installera endast inom definierade skyddsområden och vidta lämpliga skyddsåtgärder.



VAARA

Sähköisku

Epäasianmukainen asennus voi johtaa vakaviin vammoihin tai jopa kuolemaan.

- ▶ Sähköliitoksen saavat tehdä vain sähköalan ammattilaiset.
- ▶ Katkaise sähkönsyöttö ennen kaapelien liittämistä.
- ▶ Tee asennus vain määritellyillä suoja-alueilla ja suorita soveltuvat varotoimenpiteet.



HÆTTA

Raflost

Ef ekki er farið rétt að við uppsetningu getur það leitt til alvarlegra meiðsla eða dauða.

- ▶ Eingöngu faglærðir rafvirkjar mega annast tengingu við rafmagn.
- ▶ Taka skal strauminn af áður en kaplarnir eru tengdir.
- ▶ Uppsetning má eingöngu fara fram innan skilgreindra hlífðarsvæða og gera skal viðeigandi öryggisráðstafanir.



NIEBEZPIECZEŃ-STWO

Porażenie prądem

Nieprawidłowa instalacja może doprowadzić do ciężkich obrażeń lub śmierci.

- ▶ Przyłącze elektryczne może być wykonane wyłącznie przez specjalistę elektryka.
- ▶ Przed podłączeniem przewodu przerwać zasilanie.
- ▶ Instalację wykonywać wyłącznie w obrębie zdefiniowanych stref ochronnych i stosować odpowiednie środki ochronne.



VESZÉLY

Áramütés

A szakszerűtlen szerelés súlyos sérüléseket vagy halált okozhat.

- ▶ Az elektromos csatlakozás kiépítését csak képzett villamossági szakember végezheti.
- ▶ A kábel csatlakoztatása előtt szakítsa meg az áramellátást.
- ▶ A szerelést kizárólag meghatározott védelmi zónán belül szabad végezni és meg kell tenni a megfelelő védelmi intézkedéseket.



NEBEZPEČENSTVO

Zásah elektrickým prúdom

Neodborná inštalácia môže viesť k ťažkým zraneniam alebo k úmrtiu.

- ▶ Elektrické pripojenie smie vykonať iba kvalifikovaný odborný elektrikár.
- ▶ Pred pripojením káblov prerušte napájanie elektrickým prúdom.
- ▶ Inštalácia sa smie vykonať výlučne v rámci definovaných rozsahov ochrany a vhodných ochranných opatrení.



NEBEZPEČÍ

Úraz elektrickým proudem

Neodborná instalace může způsobit vážná zranění nebo usmrcení.

- ▶ Přívod elektřiny smí připojovat pouze kvalifikovaný elektrikář.
- ▶ Před připojením kabelu přerušte napájení elektrickým proudem.
- ▶ Instalaci provádějte výhradně v rámci stanovených ochranných zón a přijměte vhodná bezpečnostní opatření.



NEVARNOST

Električni udar

Neustrežna inštalacija lahko povzroči hude poškodbe ali smrt.

- ▶ Električni priključek lahko izvede samo usposobljeni električar.
- ▶ Pred priključitvijo kabla je treba prekiniti dovod električnega toka.
- ▶ Inštalacijo je treba opraviti samo znotraj določenih zavarovanih območij. Poleg tega je treba izvesti ustrezne varnostne ukrepe.



OPASNOST

Električni udar

Nestručna instalacija može prozročiti teške ozljede ili smrt.

- ▶ Priključak struje smiju izvesti samo obrazovani kvalificirani električari.
- ▶ Prije priključivanja kabela prekinite opskrbu električnom energijom.
- ▶ Instalaciju izvedite isključivo unutar definiranih područja zašтите te poduzmite odgovarajuće mjere zašтите.



OPASNOST

Električni udar

Nestručna instalacija može da dovede do ozbiljnih povreda ili smrti.

- ▶ Priključivanje električnog napajanja sme da izvrši samo obučeni električar.
- ▶ Pre priključivanja kablova prekinite napajanje strujom.
- ▶ Instalaciju obavljajte isključivo unutar definisanih područja zašтите i preduzmite odgovarajuće mere zašтите.



OHT

Elektrilöök

Asjatundmatu paigaldamine võib põhjustada raskeid vigastusi või surma.

- ▶ Elektriühenduse tohib luua ainult väljaõppinud elektri-valdkonna spetsialist.
- ▶ Enne kaabli ühendamist katkestage voolutoide.
- ▶ Tehke paigaldus ainult määratud kaitsealade ulatuses ja võtke kasutusele vastavad kaitsemeetmed.



BĪSTAMI

Elektriskās strāvas trieciens

Nepareiza uzstādīšana var izraisīt nopietnas traumas vai nāvi.

- ▶ Elektrisko pieslēgumu drīkst veikt tikai profesionāls elektriķis.
- ▶ Pirms kabeļu pieslēgšanas pārtraukt strāvas padevi.
- ▶ Instalāciju veikt tikai noteiktās aizsardzības zonās un ievērot piemērotus aizsardzības pasākumus.



PAVOJINGA

Elektros smūgis

Netinkamai sumontavus gali būti sunkiai sužaloti arba žūti asmenys.

- ▶ Prijungimo prie elektros tinklo darbus gali atlikti tik kvalifikuoti elektrikai.
- ▶ Prieš prijungiant kabelį būtina nutraukti elektros tiekimą.
- ▶ Prijungimą atlikite tik apibrėžtoje saugos zonoje ir laikydamiesi privalomų saugos priemonių.



ОПАСНОСТ

Токов удар

Неправилният монтаж може да доведе до тежки наранявания и смърт.

- ▶ Електрическото свързване трябва да бъде извършвано само от обучен електротехник.
- ▶ Преди свързването на кабелите прекъснете електрическото захранване.
- ▶ Извършвайте инсталацията само в границите на определени зони на защита и прилагайте подходящи предпазни мерки.



PERICOL

Electrocutare

Instalarea necorespunzătoare poate duce la vătămări corporale grave sau deces.

- ▶ Racordarea electrică trebuie efectuată doar de electricieni calificați.
- ▶ Înainte de racordarea cablului, întrerupeți alimentarea de la sursa de curent.
- ▶ Instalarea trebuie realizată exclusiv în perimetrul zonelor de protecție definite și trebuie luate măsuri de protecție adecvate.



ΚΙΝΔΥΝΟΣ

Ηλεκτροπληξία

Η λανθασμένη εγκατάσταση μπορεί να οδηγήσει σε σοβαρούς τραυματισμούς ή θάνατο.

- ▶ Η ηλεκτρική σύνδεση επιτρέπεται να πραγματοποιηθεί μόνο από εκπαιδευμένο ηλεκτρολόγο.
- ▶ Πριν από τη σύνδεση των καλωδίων, να διακόψετε την παροχή τάσης.
- ▶ Πραγματοποιήστε την εγκατάσταση αποκλειστικά εντός καθορισμένων πεδίων προστασίας και λάβετε τα κατάλληλα προστατευτικά μέτρα.



TEHLİKE

Elektrik çarpması

Hatalı kurulum ağır yaralanmalara veya ölüme yol açabilir.

- ▶ Elektrik bağlantısı sadece eğitimli elektrik teknisyeni tarafından yapılabilir.
- ▶ Kabloları bağlamadan önce güç ünitesini kapatın.
- ▶ Kurulumu sadece tanımlı koruma alanları içinde yapın ve uygun koruma önlemleri alın.



ОПАСНО

Удар электрическим током
Неквалифицированная установка может привести к получению тяжелых травм и к летальному исходу.

- ▶ Подключение к электросети разрешается выполнять только электротехническому квалифицированному персоналу.
- ▶ Перед подсоединением кабелей отключить подачу электропитания.
- ▶ Установку необходимо проводить исключительно в пределах установленных безопасных зон с соблюдением соответствующих мер безопасности.



危険

电击

安装不当可能导致重伤或死亡。

- ▶ 仅允许经过培训的电工进行电气连接。
- ▶ 在连接电缆前切断电源。
- ▶ 只在规定的防护区域内进行安装并采取适当的防护措施。



خطر

صدمة كهربائية

قد يؤدي التركيب غير السليم إلى إصابات بالغة ويتسبب في الوفاة.

- ▶ لا يسمح بإجراء التوصيل الكهربائي إلا بمعرفة شخص ماهر كهربائيًا مؤهل.
- ▶ قم بفصل التيار الكهربائي قبل توصيل الكابل.
- ▶ يجب عدم القيام بالتركيب إلا في مناطق الحماية المحددة واتخاذ التدابير الوقائية المناسبة.

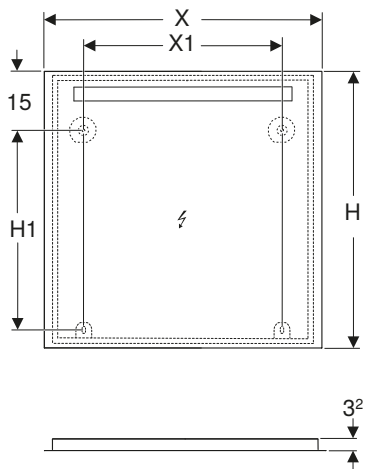

H	X	X1	H1
70	40	22	50 ⁵
	50	30	50 ⁵
	60	40	50 ⁵
	70	50	50 ⁵
	80	60	50 ⁵
	90	70	50 ⁵
	100	80	50 ⁵
	120	100	50 ⁵
	140	120	50 ⁵
90	60	40	70 ⁵
	80	60	70 ⁵
	100	80	70 ⁵
	120	100	70 ⁵
	140	120	70 ⁵



1

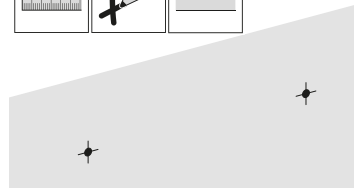
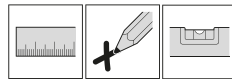

2

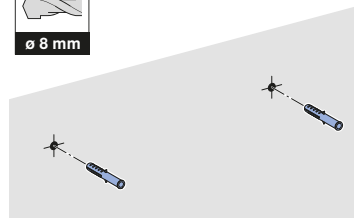

3

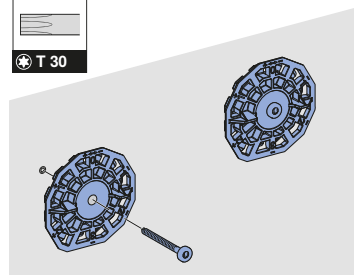

i

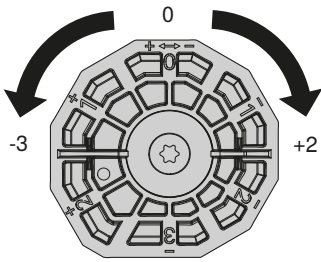

4

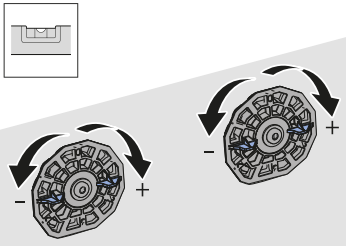

2



→ **2 A** 11

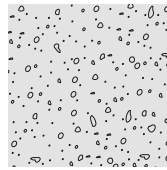

→ **2 B** 13

2 A

1

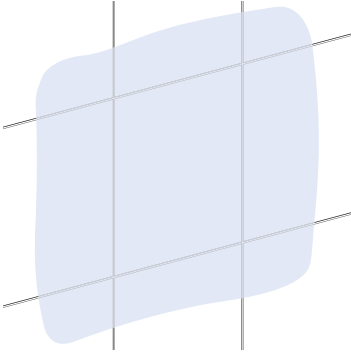

2

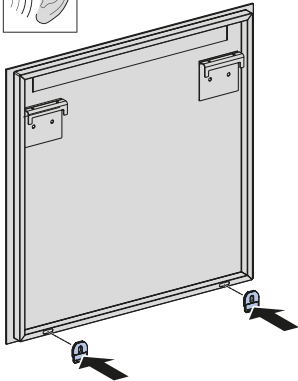

3

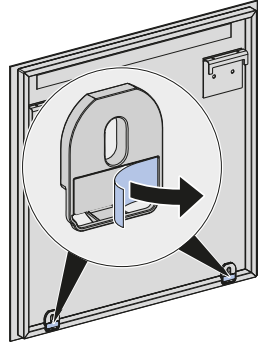

4

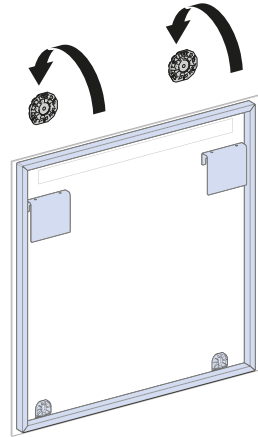

5

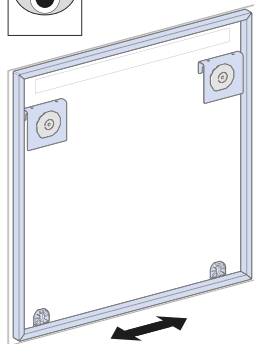

6

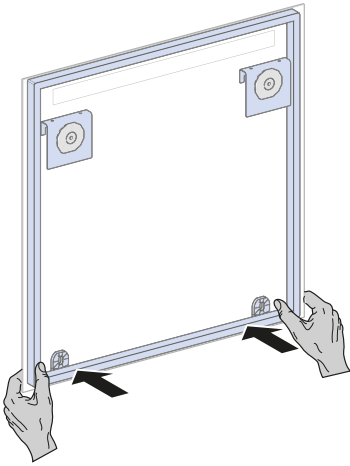

7

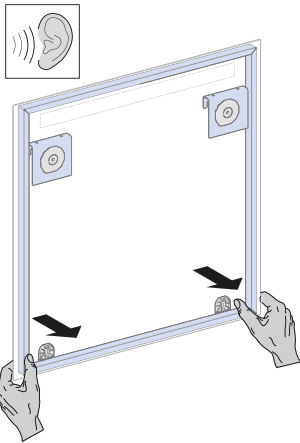

8

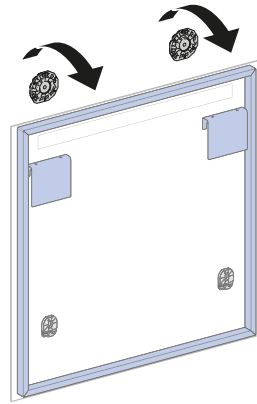

9

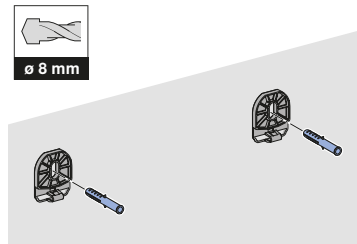

10

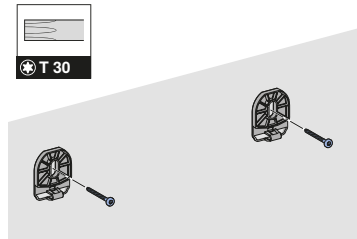

➔ **3** 14

2 B

1

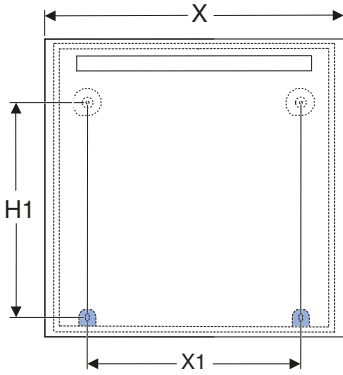

2

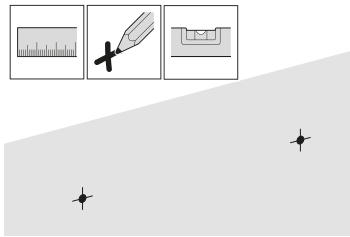

3

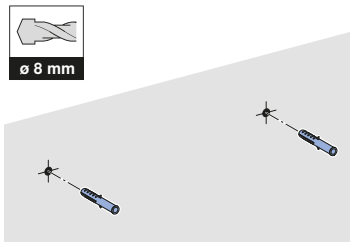

4

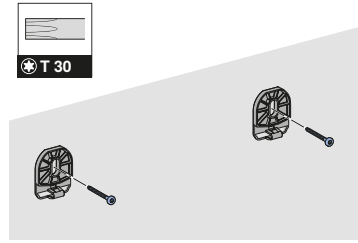

5

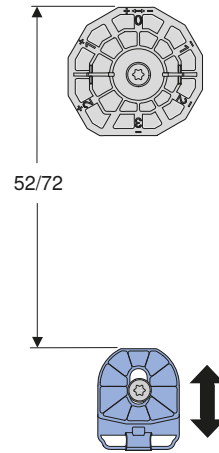

3

✓

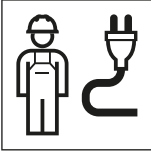

1

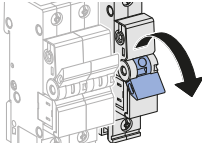

2

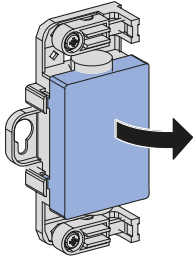

3

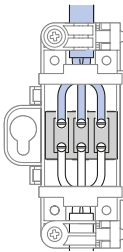

4

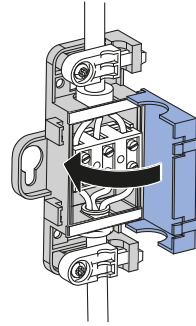

5

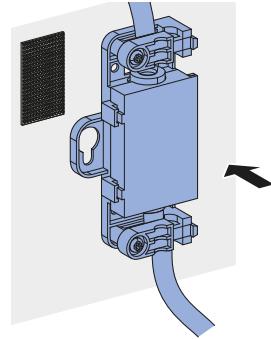

4

1

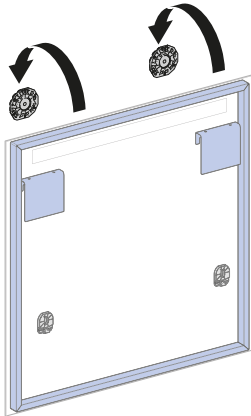

2

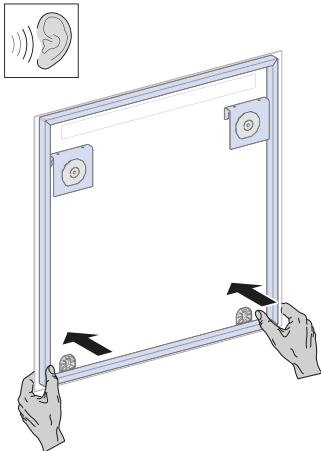

5

✓



▶

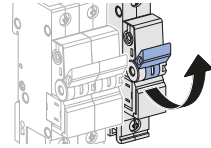



Geberit International AG
Schachenstrasse 77, CH-8645 Jona
documentation@geberit.com
www.geberit.com