

BFL

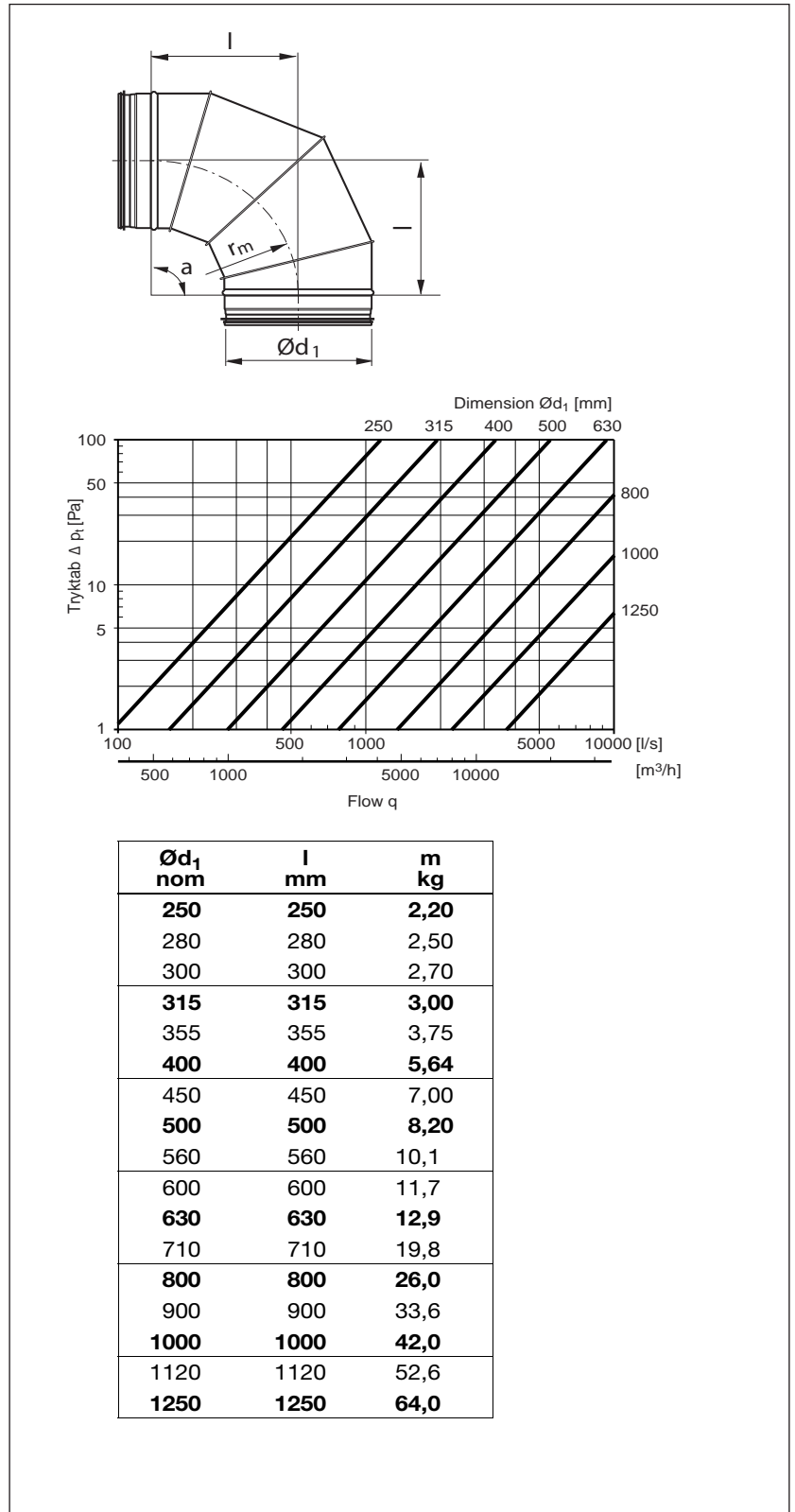

Falset bøjning samlet af segmenter. BFL-90 vises i eksemplet her til højre



Ordreeksempel

$$r_m = l \cdot d_1$$

Produkt	BFL	315	90
Dimension Ød1			
Vinkel			

BFL-60

BFL-45

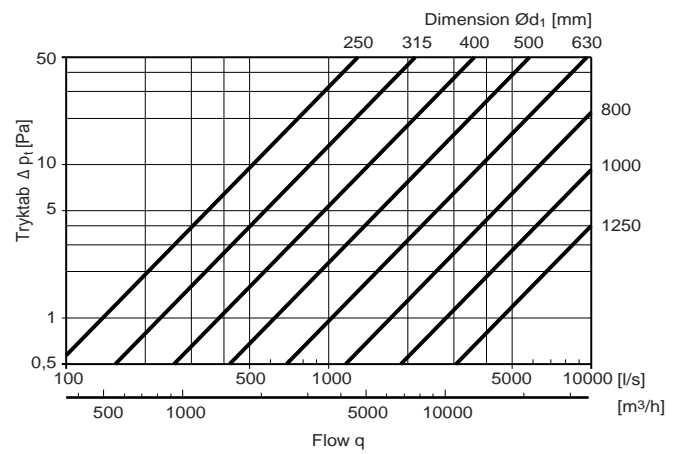
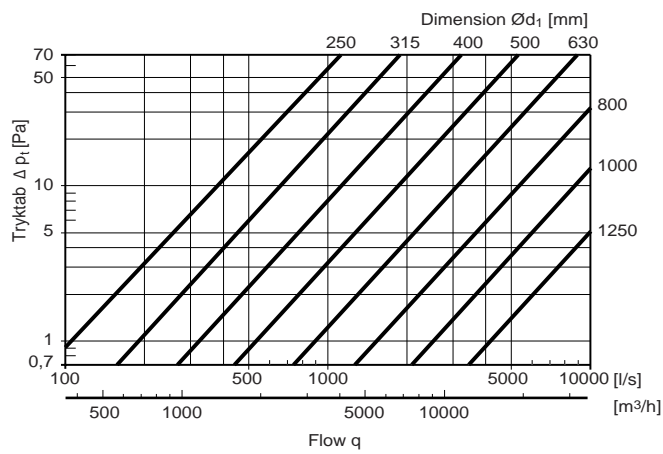
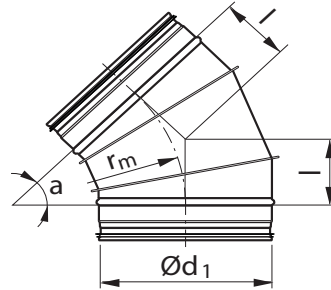
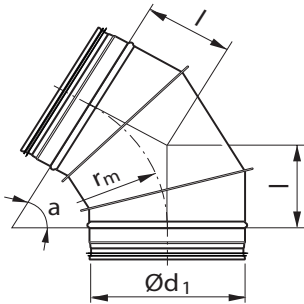

Ød ₁ nom	l mm	m kg
250	144	1,48
280	162	1,80
300	173	2,00
315	182	2,20
355	205	2,80
400	231	3,47
450	260	4,70
500	289	6,00
560	323	7,40
600	346	8,60
630	364	9,20
710	410	11,3
800	462	14,8
900	520	19,3
1000	577	24,2
1120	647	30,1
1250	722	36,6

Ød ₁ nom	l mm	m kg
250	104	1,26
280	116	1,54
300	124	1,77
315	130	1,90
355	147	2,26
400	166	2,96
450	186	4,00
500	207	4,90
560	232	6,10
600	249	6,80
630	261	7,49
710	294	11,3
800	331	15,0
900	373	16,8
1000	414	19,5
1120	464	28,5
1250	518	38,0

BFL-30

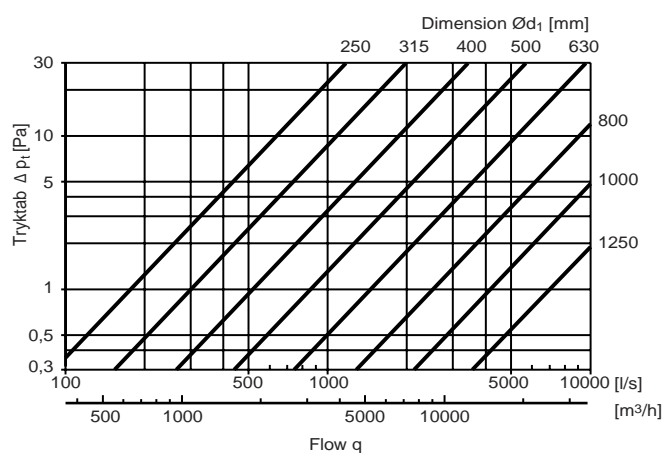
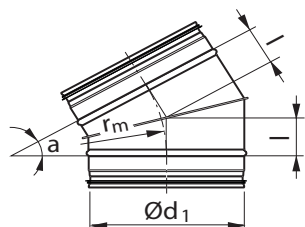

Ød ₁ nom	l mm	m kg
250	67	1,00
280	75	1,10
300	80	1,30
315	84	1,42
355	95	1,70
400	107	2,27
450	121	3,00
500	134	3,70
560	150	4,60
600	161	5,10
630	169	5,60
710	190	8,60
800	214	11,0
900	241	10,9
1000	268	13,4
1120	300	16,1
1250	335	19,0

BFL-15

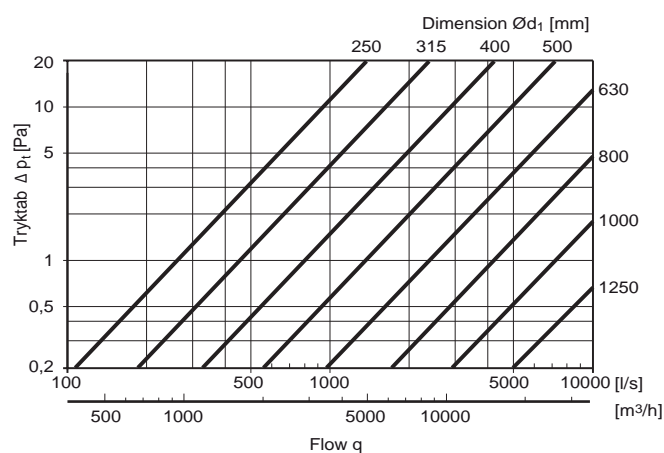
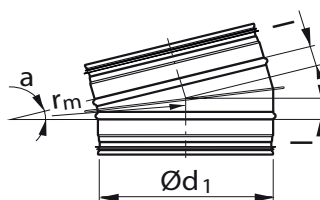

Ød ₁ nom	l mm	m kg
250	33	0,65
280	37	0,77
300	39	0,85
315	41	0,91
355	47	1,41
400	53	1,70
450	59	2,20
500	66	2,65
560	74	3,30
600	79	3,70
630	83	4,00
710	93	5,80
800	105	7,00
900	118	8,50
1000	132	10,4
1120	147	12,5
1250	165	14,5