

RCPL - RCFPL

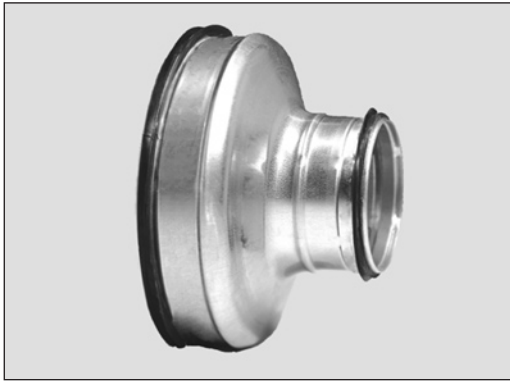

RCPL

Presset koncentrisk reduktion for at møde krav for kort installations længde med lav tryktab og lav støjniveau

RCFPL

Presset koncentrisk reduktion med muffe med 45 gr. vinkel for at møde krav om kort installations længde med lav støj niveau. $\varnothing d$ passer udvendigt på andet fittings. For mellemliggende dimensioner se side. 24.

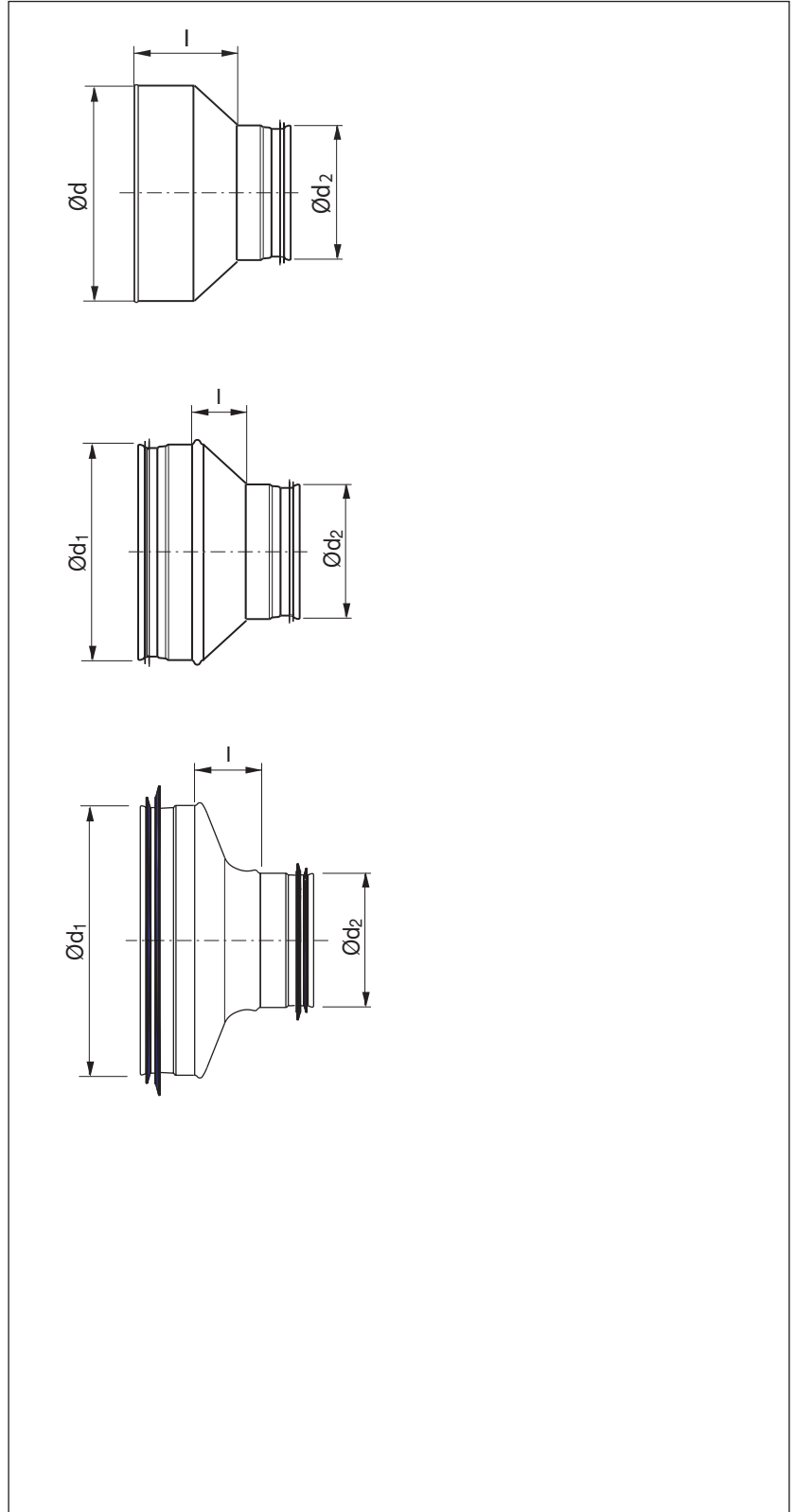

Ordreseksempl

	RCFPL	200	100
Produkt			
Dimension $\varnothing d1$			
Dimension $\varnothing d2$			

Ød nom	Ød ₂ nom	l mm	m kg
80	63	93	0,14
100	63	121	0,20
100	80	98	0,18
125	63	155	0,28
125	80	132	0,26
125	100	104	0,24
160	63	203	0,43
160	80	180	0,42
160	100	152	0,40
160	125	118	0,36
200	80	235	0,61
200	100	207	0,59
200	125	173	0,55
200	160	125	0,50
250	100	296	0,94
250	125	262	0,90
250	160	214	0,87
250	200	159	0,75
315	125	351	1,36
315	160	303	1,31
315	200	248	1,21
315	250	179	1,09
355	160	358	1,70
355	200	303	1,50
355	250	234	1,30
355	315	145	1,10
400	160	445	2,44
400	200	390	2,31
400	250	321	2,20
400	315	232	1,86
400	355	177	1,60
450	200	458	2,80
450	250	390	2,60
450	315	301	2,30
450	355	246	2,10
450	400	189	2,00
500	200	527	3,66
500	250	458	3,51
500	315	369	3,16

Ød nom	Ød ₂ nom	l mm	m kg
500	355	314	2,70
500	400	257	2,69
500	450	189	2,30
560	250	541	4,00
560	315	451	3,37
560	355	397	3,50
560	400	340	3,40
560	450	271	3,10
560	500	202	2,70
630	250	637	5,60
630	315	548	5,25
630	355	493	5,00
630	400	436	4,79
630	450	367	4,40
630	500	299	4,00
630	560	216	3,30
710	355	628	6,70
710	400	571	6,60
710	450	502	6,20
710	500	433	5,70
710	560	351	5,10
710	630	255	4,20
800	400	694	8,81
800	450	626	8,50
800	500	557	8,02
800	560	475	7,40
800	630	379	6,62
800	710	274	5,60
1000	500	852	13,1
1000	560	769	15,0
1000	630	673	11,7
1000	710	568	12,6
1000	800	445	9,91
1250	630	1057	19,7
1250	710	952	24,4
1250	800	828	17,9
1250	1000	553	14,4

RCPL, RCFPL
1 dimensionstrin

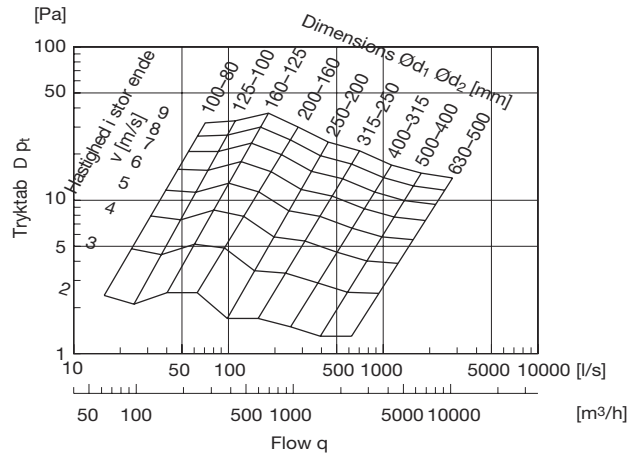
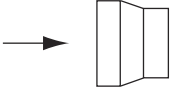

RCPL, RCFPL
2 dimensionstrin

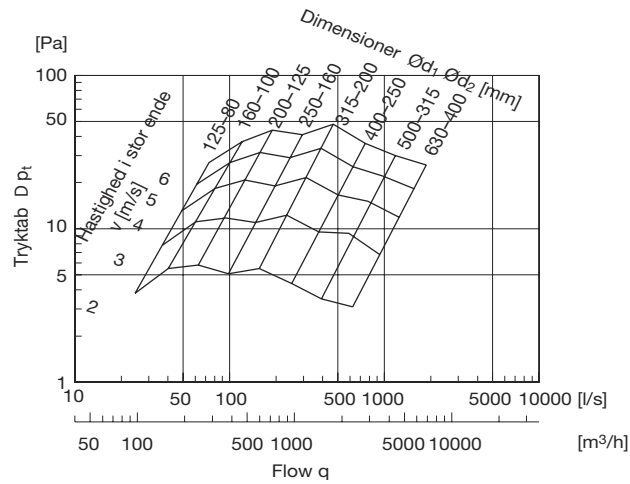
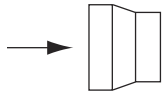

RCPL, RCFPL
3 dimensionstrin

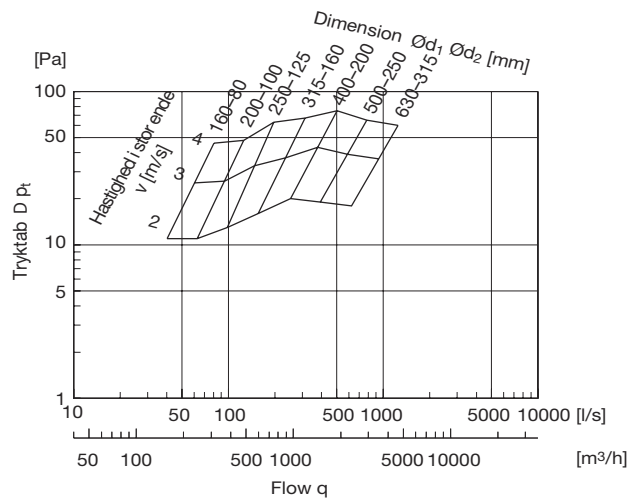
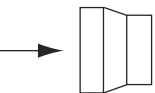

RCPL, RCFPL
1 dimensionstrin

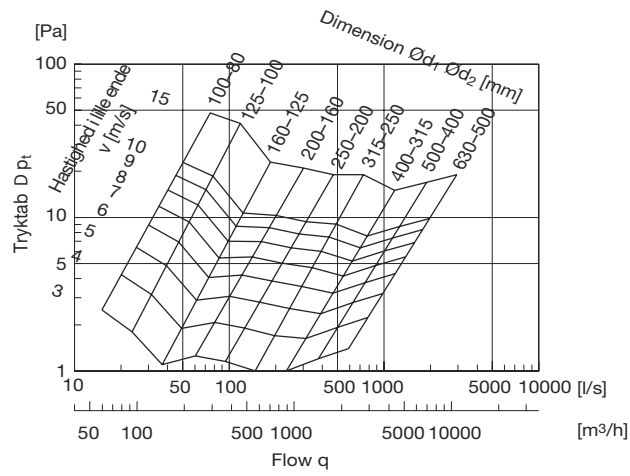
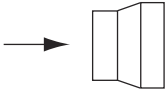

RCPL, RCFPL
2 dimensionstrin

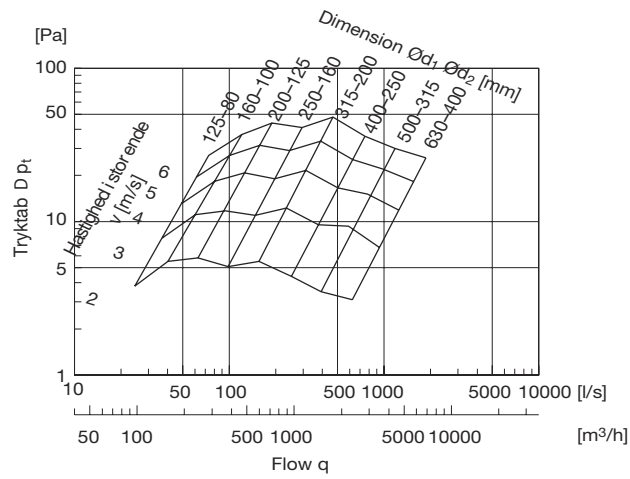
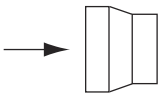

RCPL, RCFPL
3 dimensionstrin

