

## Data Sheet

# FH-ME Floor Heating Manifold

## Application

The FH-ME Manifold is used for controlling water flow in under floor heating systems. Each tube of the floor heating system is connected to the manifold, thus making it possible to control water flow or heat supply to each room in the building individually.

The manifold consists of a supply and return manifold. The supply manifold includes possibility for individual shut-off of each circuit and as a flow adjustment. The return manifold is equipped with integrated Danfoss RA connection. The valves can be controlled electronically by thermal actuators or act as self-acting units by means of remote temperature adjusters.

The manifold is supplied in modules of 2 to 8 outlets. In addition extension pieces are available for connecting the manifolds in series. Ball valves are available as an option for positive shut-off between manifold and system.

The end pieces FHF-EM and FHF-EA are supplied with manual airvent or alternatively with automatic airvent, purge and valve. The end pieces are placed at the end of the manifold.

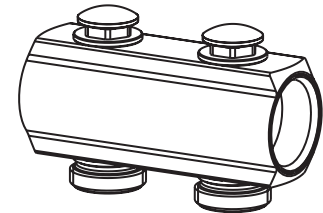
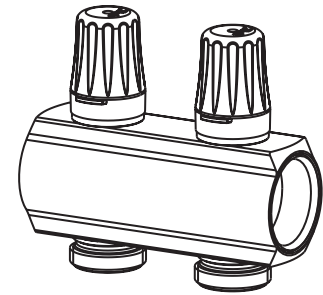



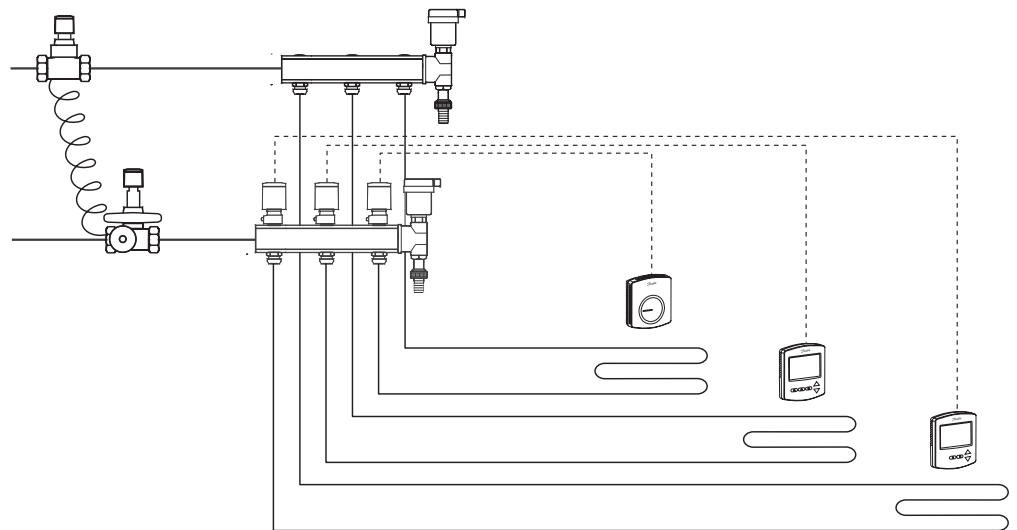

*FH-ME supply**FH-ME return*

## System Layout

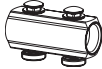











## Data Sheet

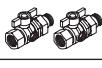

### Ordering

Description	Type	Code no.
 Manifold set 2+2	FH-ME2	<b>088U0612</b>
 Manifold set 3+3	FH-ME3	<b>088U0613</b>
 Manifold set 4+4	FH-ME4	<b>088U0614</b>
 Manifold set 5+5	FH-ME5	<b>088U0615</b>
 Manifold set 6+6	FH-ME6	<b>088U0616</b>
 Manifold set 7+7	FH-ME7	<b>088U0617</b>
 Manifold set 8+8	FH-ME8	<b>088U0618</b>

### Accessories

Description	Type	Code no.
 End section - automatic airvent and purge valve	FHF-EA	<b>088U0580</b>
 End section - manual airvent and purge valve	FHF-EM	<b>088U0581</b>
 End caps - set	FHF-E	<b>088U0582</b>
 Connection pieces - set	FHF-C	<b>088U0583</b>
 Reduction bushes/pieces -set 1" - 3/4"	FHF-R	<b>088U0584</b>
 Mounting brackets - set	FHF-MB	<b>088U0585</b>
 2 x ball valve 1" with tail piece - for connection to manifold and for blocking of floor heating system	FHF-BV	<b>088U0586</b>
 1 x thermometer 0-60°C Ø35mm - for flow/return temperature measurement	FHF-T	<b>088U0029</b>
 Thermal actuator, 24 V, NC, Danfoss RA connection to valve	TWA-A	<b>088H3110</b>
 Thermal actuator, 230 V, NC, Danfoss RA connection to valve	TWA-A	<b>088H3112</b>
 Thermal actuator, 24 V, NC, with end switch, Danfoss RA connection to valve	TWA-A	<b>088H3114</b>

### Compression Fittings

Description	Type	Code no.
 Compression fittings for <b>PEX</b> tubing in accordance with ISO 15875. <ul style="list-style-type: none"> <li>• Max working pressure: 6 bar</li> <li>• Test pressure: 10 bar</li> <li>• Max. flow temperature: 95 °C</li> <li>• G 3/4" internal thread</li> </ul>	16x2 mm	<b>013G4156</b>
	20x2 mm	<b>013G4160</b>
	20x2.25 mm	<b>013G4093</b>
	20x2.5 mm	<b>013G4161</b>
 Compression fittings for <b>ALUPEX</b> tubing. <ul style="list-style-type: none"> <li>• Max working pressure: 6 bar</li> <li>• Test pressure: 10 bar</li> <li>• Max. flow temperature: 95 °C</li> <li>• G 3/4" internal thread</li> </ul>	16x2 mm	<b>013G4186</b>
	20x2 mm	<b>013G4190</b>
	20x2.25 mm	<b>013G4093</b>
	20x2.5 mm	<b>013G4191</b>
 Compression fittings for <b>STEEL</b> and <b>COPPER</b> tubing <ul style="list-style-type: none"> <li>• Max working pressure: 6 bar</li> <li>• Test pressure: 10 bar</li> <li>• Max. flow temperature: 95 °C</li> <li>• G 3/4" internal thread</li> </ul>	16 mm	<b>013G4126</b>
	18 mm	<b>013G4128</b>

Note: Max flow temperature given by the tube manufacturer must not be exceeded.

## Data Sheet

### Commissioning

The pre-setting of the manifold valves determines the flow in the floor heating tubes and is therefore an important factor for obtaining optimal hydraulic balance in the system.

A correct hydraulic balance is important if optimal comfort shall be achieved with a minimum of energy consumption and is easily carried out following the example shown below.

#### Example

Room 1:	1. Determine longest tube/largest room	25 m <sup>2</sup>
	2. Desired cooling (ΔT)	5° C (typical)
	3. Determine heat requirement for the room	50 W/m <sup>2</sup>
	4. Conversion factor	1.16
	5. Calculation of flow for the room	$Q \text{ (l/h)} = \frac{50 \text{ W/m}^2 \times 25 \text{ m}^2}{10^\circ \text{ C} \times 1.16} = 108 \text{ l/h}$
Room 2:	6. Determine area for the next room	15 m <sup>2</sup>
	7. Calculation of flow for the room (ΔT and heat requirement is assumed identical for the rooms in this case)	$Q \text{ (l/h)} = \frac{50 \text{ W/m}^2 \times 15 \text{ m}^2}{10^\circ \text{ C} \times 1.16} = 65 \text{ l/h}$

### Capacity

The diagram shows the capacities of each heating circuit for different settings of the flow manifold.

The figures 3/4 to 4 above the diagram indicate how many turns of the key are required to obtain the correct water volume (count from closed position onwards).

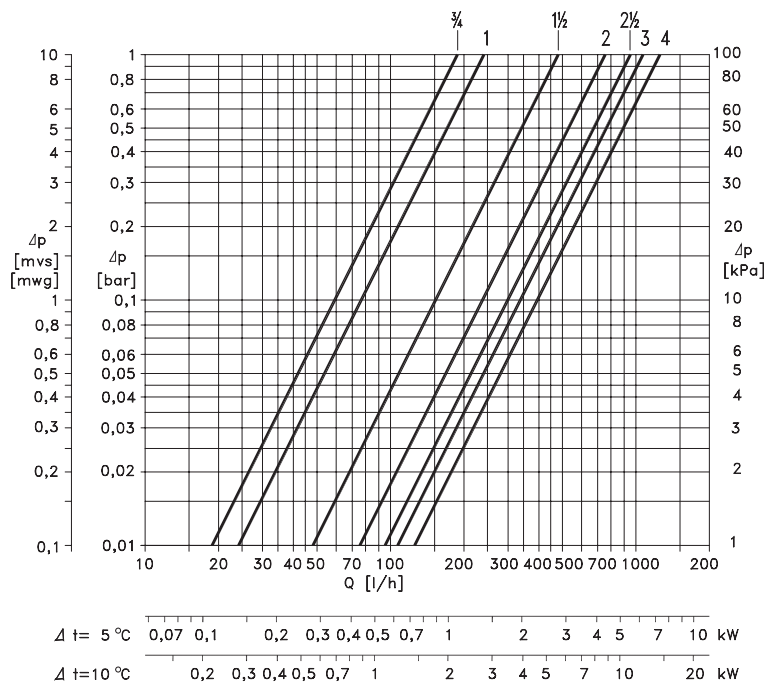
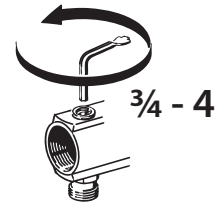

### Operation Conditions

Max. differential pressure..... 0.6 bar  
 Max. working pressure ..... 10 bar  
 Max. test pressure ..... 16 bar  
 Max. flow temperature ..... 90° C

**Dimensions**

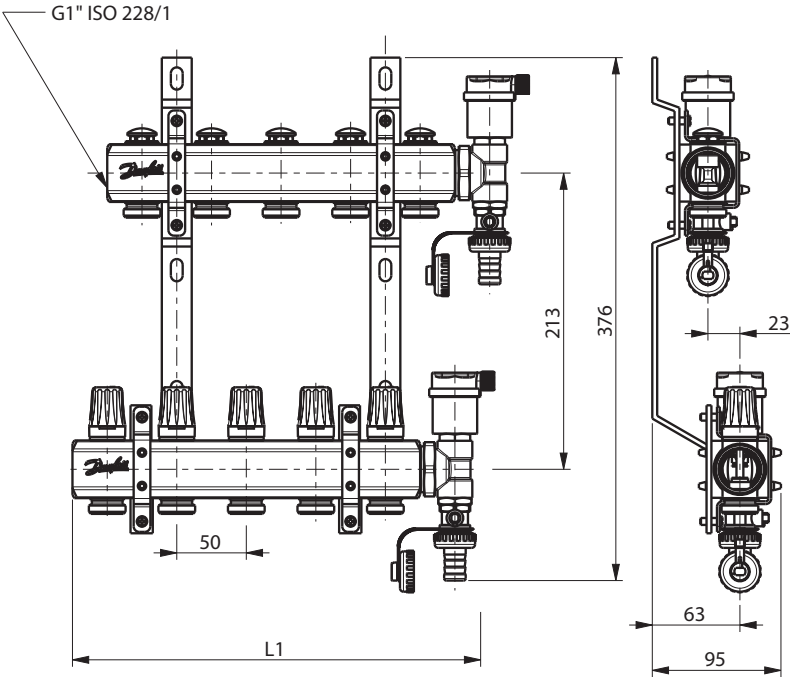

Type	2+2	3+3	4+4	5+5	6+6	7+7	8+8
L1 (mm)	143	193	243	293	343	393	443

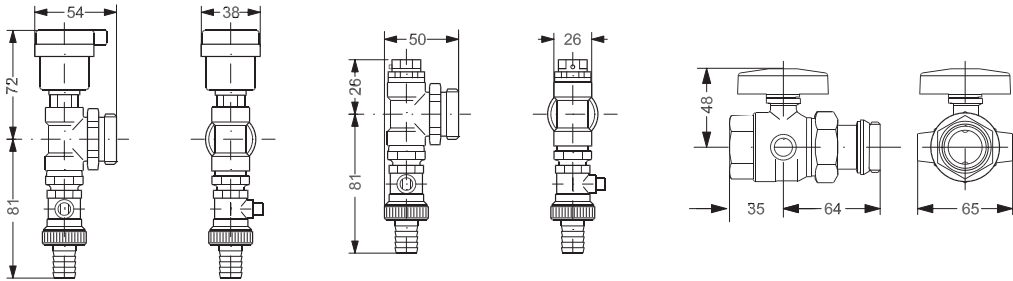

**Danfoss A/S**

Floor Heating Hydronics • Ulvehavevej 61 • DK-7100 Vejle • Denmark • Phone: +45 7488 8500 • Fax: +45 7488 8501  
 heating@danfoss.com • www.floorheating.danfoss.com

Danfoss can accept no responsibility for possible errors in catalogues, brochures and other printed material. Danfoss reserves the right to alter its products without notice. This also applies to products already on order provided that such alterations can be made without subsequential changes being necessary in specifications already agreed. All trademarks in this material are property of the respective companies. Danfoss and the Danfoss logotype are trademarks of Danfoss A/S. All rights reserved.