

Paul Neuhaus

Paul Neuhaus GmbH
Olakenweg 36 · 59457 Werl
Germany

Telefon: +49 (0) 29 22-97 21-0
Telefax: +49 (0) 29 22-97 21-9120
E-mail: info@neuhaus-group.de
<https://scm.paul-neuhaus.de/public/conformity/>



D | Montageanleitung GB | Fitting instructions

- DE** Dieses Produkt enthält Lichtquellen der Energieeffizienzklasse <F>.
- GB** This product contains light sources of energy efficiency class <F>.
- FR** Ce produit comprend sources lumineuses de classe d'efficacité énergétique <F>.
- BG** Продуктът съдържа източници на светлина с клас на енергийна ефективност <F>.
- CZ** Tento výrobek obsahuje světelné zdroje třídy energetické účinnosti <F>.
- DK** Dette produkt indeholder lyskilder af energieeffektklasse <F>.
- EL** Αυτό το προϊόν περιέχει πηγές φωτός της τάξης ενεργειακής απόδοσης <F>.
- ES** Este producto contiene fuentes de luz de la clase de eficiencia energética <F>.
- ET** See toode sisaldab valgusallikad energiatõhusklassiga <F>.
- FI** Tämä tuote sisältää energiatehokkuusluokan <F> valonlähteet.
- HR** Ovaj proizvod sadrži izvori svjetlosti energetskeg razreda <F>.
- HU** Ez a termék <F> energiatákonysági osztályba tartozó fényforrások tartalmaz.
- IT** Questo prodotto contiene sorgenti luminose della classe di efficienza energetica <F>.
- LT** Šis produktas yra su šviesos šaltiniai, kurio energinio efektyvumo klasė yra <F>.
- LV** Šis izstrādājums satur gaismas avoti, kas atbilst energoefektivitātes klasei <F>.
- NL** Dit product bevat lichtbronnen van energie-efficiëntieklasse <F>.
- NO** Dette produktet inneholder lyskilder i energieffektivitetsklasse <F>.
- PL** Produkt ten zawiera źródła światła o klasie efektywności energetycznej <F>.
- PT** Este produto contém fontes de luz da classe de eficiência energética <F>.
- RO** Acest produs conține surse de lumină din clasa de eficiență energetică <F>.
- RU** Данное изделие содержит источники света класса энергоэффективности <F>.
- SK** Tento výrobok obsahuje svetelné zdroje triedy energetickej efektivity <F>.
- SL** Ta izdelek vsebuje viri svetlobe razreda energijske učinkovitosti <F>.
- SR** Ovaj proizvod sadrži izvori svjetlosti energetske klase <F>.
- SV** Denna produkt innehåller ljuskällor i energieffektivitetsklass <F>.
- TR** Bu ürün, enerji verimliliği sınıfına sahip ışık kaynakları içerir <F>.

835778

230V / 50Hz~
1x LED-Board 24V DC / 23W
1x LED-Board 24V DC / 33W
nicht wechselbar / not changeable

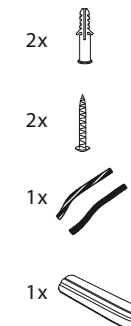
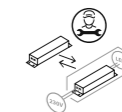
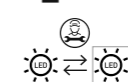
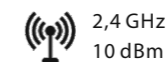

Inkl. IR-Fernbedienung
Incl. IR remote control

	23 W / 33 W
	3.000 lm / 4.300 lm
	65 W
	2.150 lm
	LED-Board
t	20.000 h
Tk	2.700-5.000 K
	15.000 x
	<0,5 s



1 | Montage / fitting

als Pendelleuchte
as Pendant light

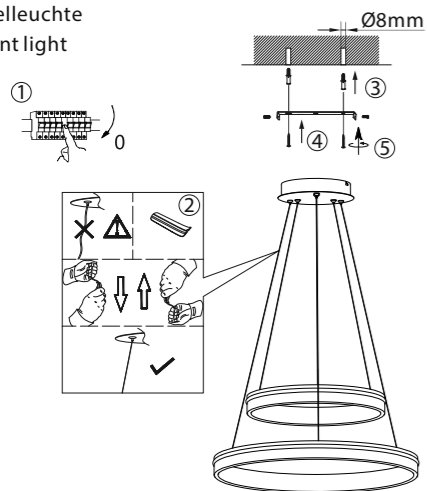

2 | Elektrischer Anschluss / electrical connection

230 Volt / 50 Hz-Anschluss
230 voltage / 50Hz - connection

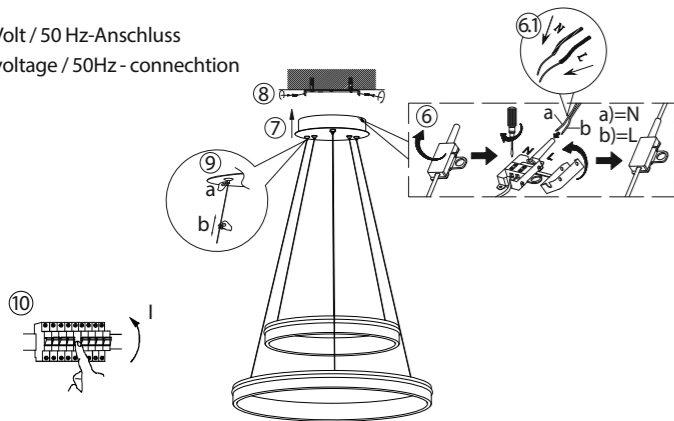

3 | Fernbedienung anlernen / teach remote control

Siehe Q-Fernbedienungsanleitung
See Q-remote control manual

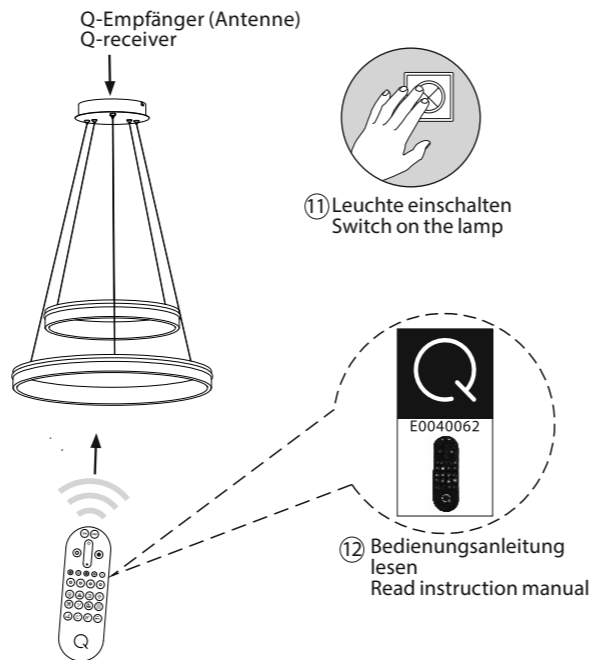

! Reset

Zur Einbindung in ein ZigBee Netzwerk, stellen Sie die
Leuchte auf Werkseinstellung zurück.

To integrate the lamp into a ZigBee network, reset the
lamp to the factory setting.

