

551-18000
551-18001



Niko Home Control
4 year warranty

EN	Digital black, connected control screen, 230 V
NL	Digital black, geconnecteerd bedieningsscherm, 230 V
FR	Digital black, écran de commande connecté, 230 V
DE	Digital black, angeschlossener Bedienbildschirm, 230 V
DK	Digital black, tilsluttet kontrolskærm, 230 V
SE	Digital black, uppkoppladekskærm, 230 V
NO	Digital black, tilkoblet kontrollskjerm, 230 V
IT	Digital black, schermo di controllo collegato, 230 V
PL	Digital black, podłączony ekran sterowania, 230 V
SK	Digital black, pripojenej riadiacej obrazovke, 230 V

Dimensions

Åfmetingen / Dimensions / Abmessungen / Dimensioner / Mått / Dimensioner / Dimenzioni / Wymiary / Rozmery

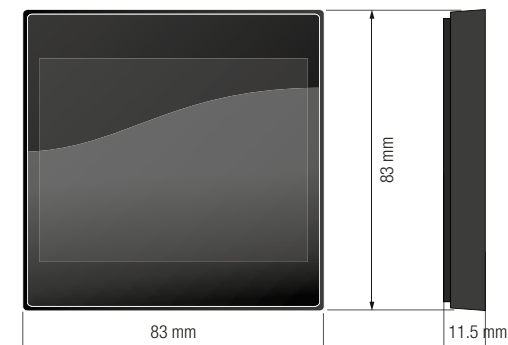
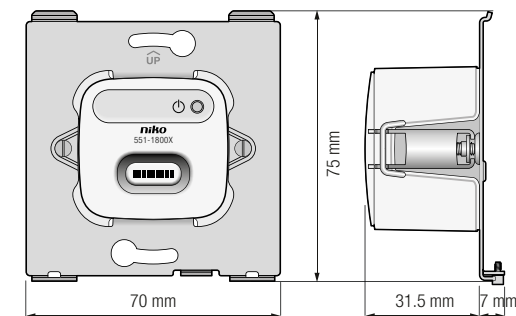

Wiring

Aansluitschema / Schéma de raccordement / Verdrahtung / Tilslutningsskema / Kopplingschema / Ledningstilkopling / Cablaggio / Okablowanie / Instalácia

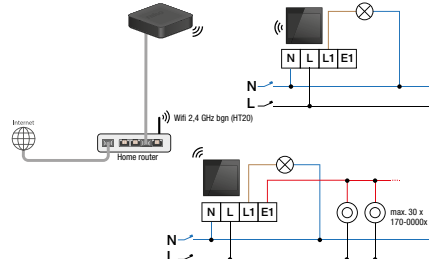

! This product must be secured with a miniature circuit breaker (MCB) of max. 16 A in the electrical cabinet.
This product must be secured with a miniature circuit breaker (MCB) of max. 16 A in the electrical cabinet. The MCB rating is limited by national installation rules

Installation

Installatie / Installation / Installation / Installation / Installation / Installasjon / Installazione / Instalacja / Inštalácia

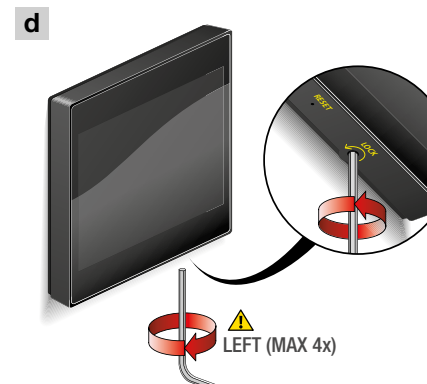
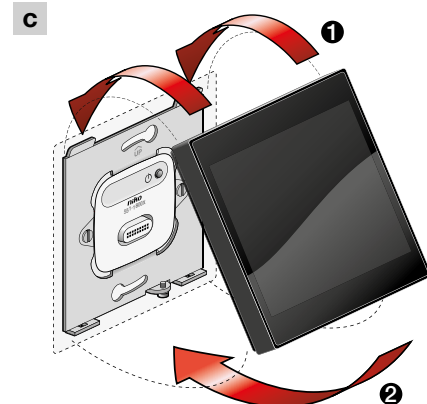
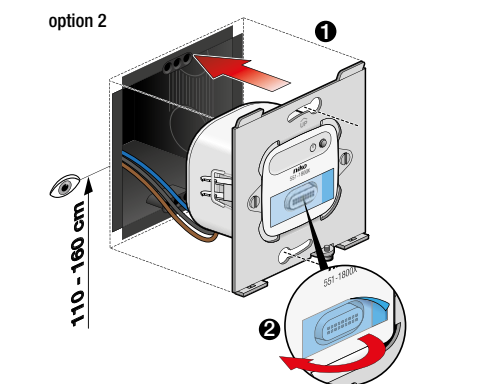
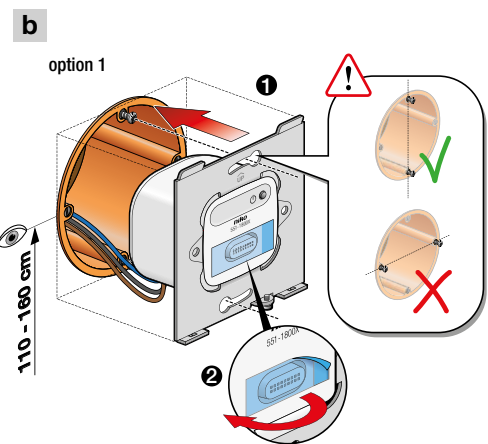
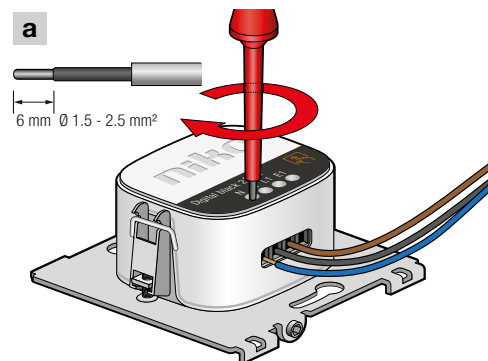

Construction site use

Gebruik op de werf / Utilisation sur chantier / Baustellennutzung / Brug af byggepladser / Användning av byggarbetsplatser / Byggeplassbruk / Utilizzare in cantiere / Używać na budowie / Použitie na stavenisku /

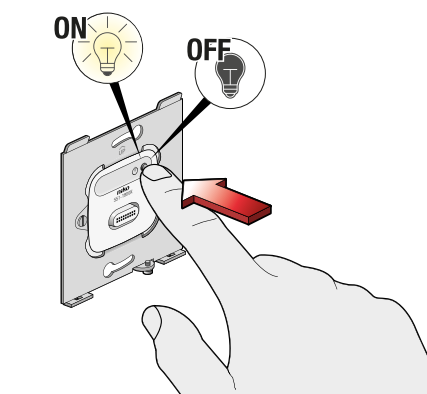

Standalone use

Zelfstandig gebruik / Utilisation autonome / Autonome Verwendung / Stand-alone brug / Fristående användning / Brukes frittstående / Uso autonomo / Użycie samodzielne / Samostatné použitie

Swipe the 'QR code' screen to go to the 'switching' screen

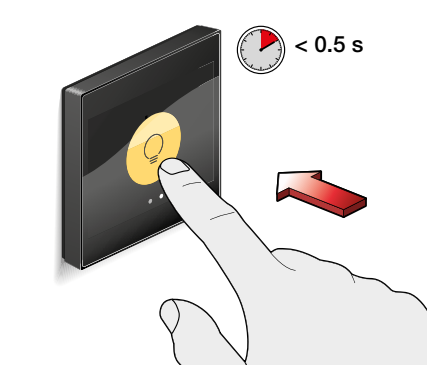

Onboarding

Onboarding / Intégration / Onboarding / Onboarding / Onboarding / Onboarding / Onboarding / Wdrożenie / Onboarding

! Before starting: Make sure your Niko Home Control installation has been correctly installed and programmed, is running programming software v. 2.8 or higher and has been registered on <http://mynikohomecontrol.niko.eu>

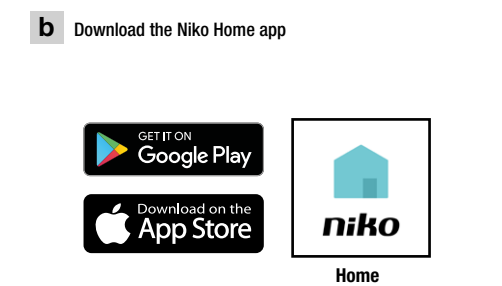
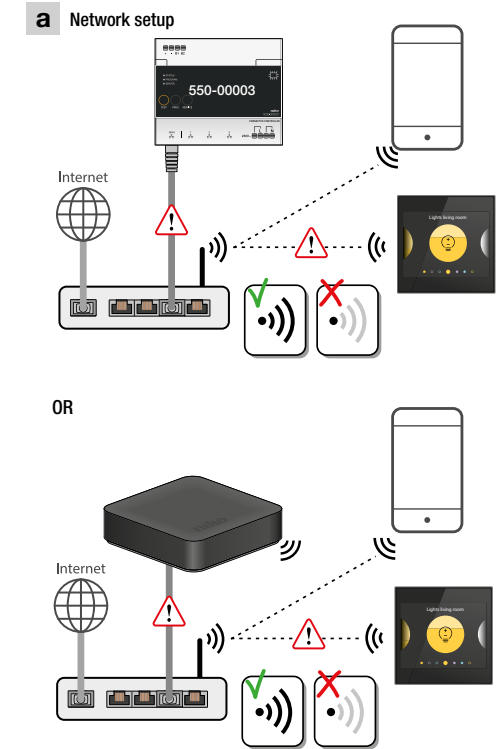

Please consult <http://guide.niko.eu> for more information.

1. Open the Niko Home app
2. Select the room where the Digital black is mounted
3. Press + Add > Add device > Digital blacks
4. Follow the instructions in the app to get the QR code on your Digital black



Online guide

Online handleiding / Manuel utilisateur en ligne / Online Benutzers-handbuch / Online brugervejledning / Online bruksanvisning / Online brukerhåndbok / Manuale utente online / Podręcznik użytkownika online / Online uživatelská príručka

! Consult guide.niko.eu for more information about the installation, the onboarding and the normal use.

<http://guide.niko.eu>



Reboot

Herstarten / Redémarrer / Neustarten / Genstart / Omstarta / Omstart / Riavvio / Restart / Reštart

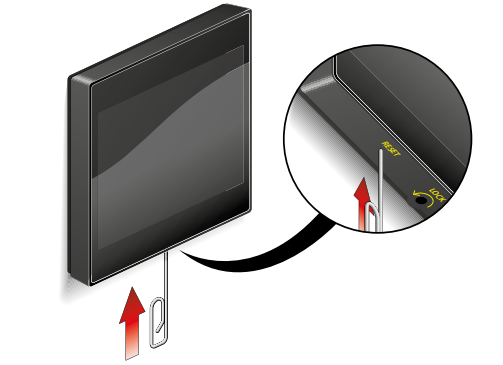

! Your Digital black's settings will be preserved. The relay will resume its last preserved state.

De instellingen van je Digital black blijven bewaard. De laatste bewaarde status van het relais wordt hervat.
Les paramètres de votre Digital black seront préservés. Le relais relancera son dernier état sauvegardé.
Die Einstellungen Ihres Touch-Schalters bleiben erhalten. Das Relais nimmt seinen letzten erhaltenen Zustand wieder ein.
Dine Digital black instillinger bliver bevaret. Relæet genoptager den senest aktive funktion.
Din Digital black inställningar kommer att bevaras. Reläet kommer att återuppta det senast sparade läget.
Dine Digital black innstillinger blir bevaret. Releet gjenopptar siste beholdte status.
Le impostazioni del tuo Digital black verranno mantenute. Il relé riprenderà il suo ultimo stato conservato.
Twoje ustawienia Digital black zostaną zachowane. Przekaznik powróci do ostatniego zachowanego stanu.
Nastavenia Digital black budú zachované. Relé obnoví naposledy uložený stav.

