

Happy D.2 Plus

HP 4347

Monteringsvejledning

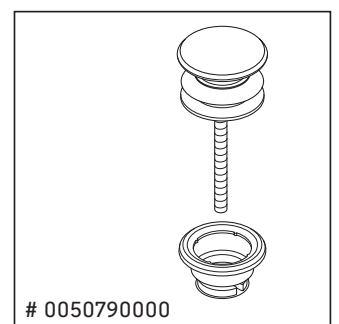
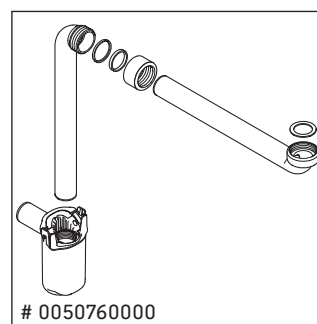
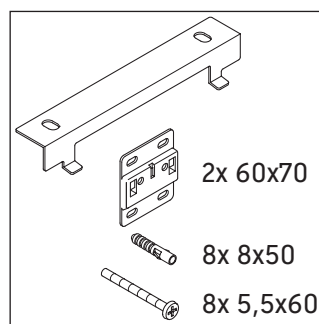
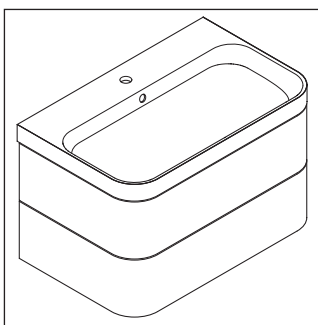
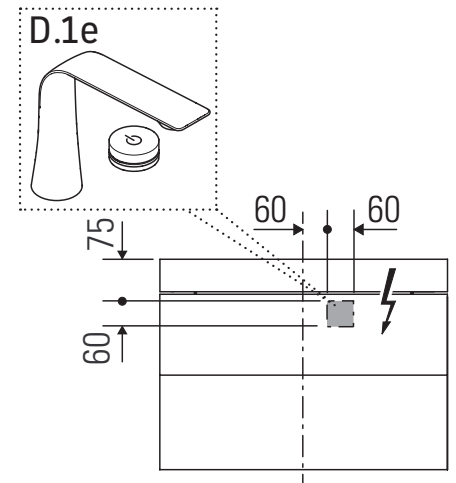
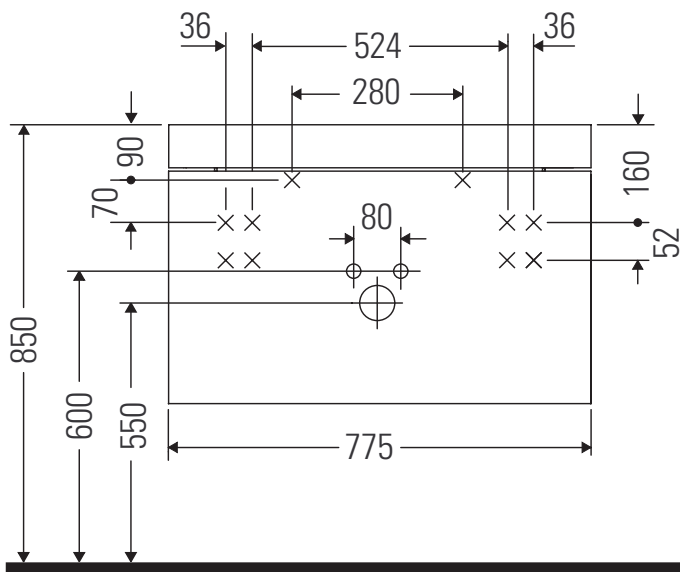

Brugsanvisninger

Badeværelsesmøblerne er på tidspunktet for leveringen i overensstemmelse med gældende normer og retningslinjer og er designet til brug i badeværelser. Direkte fugtning med vand, f.eks. ved brusebad, bør undgås.

Vi forbeholder os ret til tekniske forbedringer og ændringer af de viste produkter.



Order no. HP4347/20.01.1

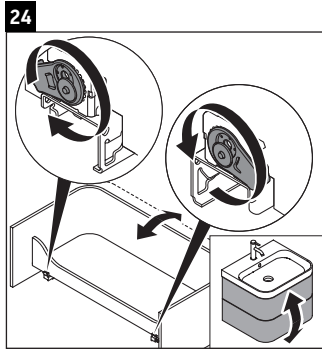
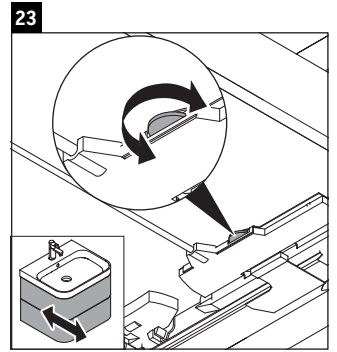
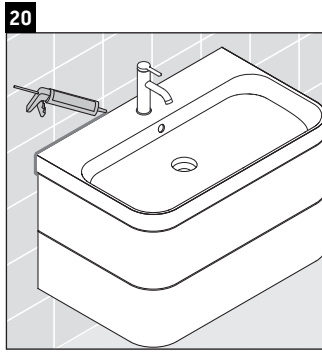

Duravit AG
P.O. Box 240
Werderstr. 36
78132 Hornberg
Germany
Phone +49 78 33 70 0
Fax +49 78 33 70 289
info@duravit.com
www.duravit.com



Order no. HP4347/20.01.1