

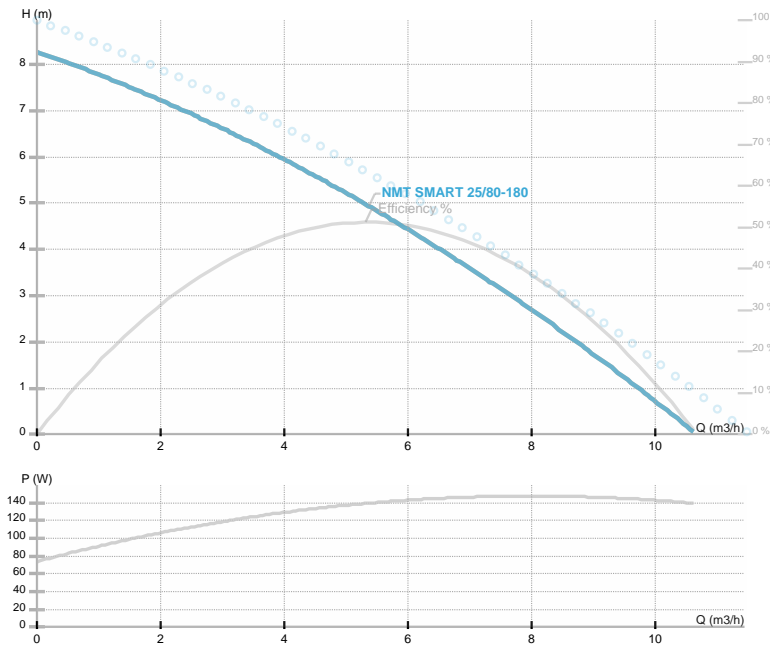

NMT SMART 25/80-180

NMT SMART / Electronically regulated circulating pump
 Heating, Climatisation



Part number	979523484
Power supply	1~230 V
Declared protection	IP44
Q max	10.63 [m³/h]
H max	8.6 [m]
RPM	4000 [1/min]
Motor power	140 [w]
Declared current	1.15 [A]
Fluid	Water VDI 2035, glycol 40%
Fluid temperature	-10.0 ÷ 110.0 [°C]
Insulation class	F
DN	25 [mm]
Connector	
Net weight	3.40 [kg]
Length	180 [mm]
Approvals	CE EAC
EEL	0.2
Efficiency	52.05 [%]
Impeller material	PES GF 30
Bearing material	Graphite
Shaft material	AISI 420
Hydraulics material	Gray cast iron
Mains frequency	50/60 Hz
Connection	
Max pressure	1.0 MPa
Ambient temp.range	40 deg C

Dimension drawing

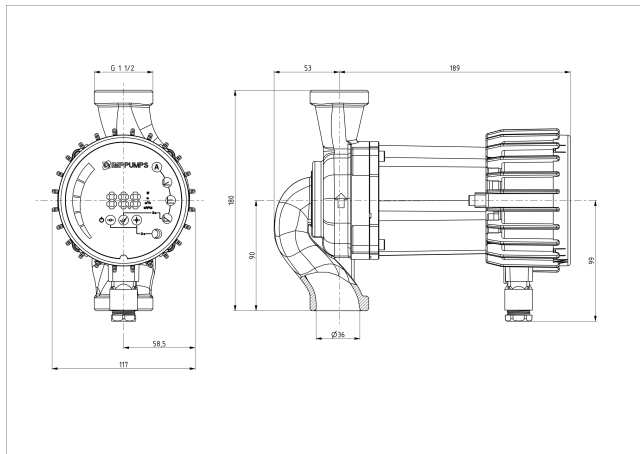

L=180 l=190 DN=25 D2=1 1/2

Electrical wiring