

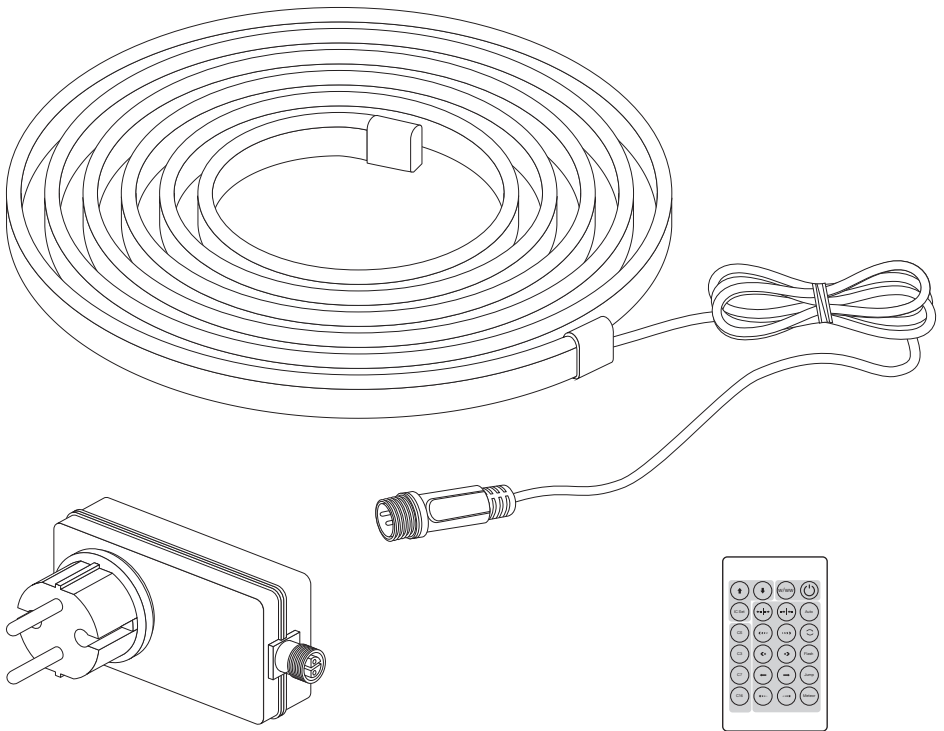

NEON DIGITAL FLEX



	EAN	W	Temp (°C)	V~	mA	Hz	▽(°)	
NEON DIGITALFLEX 3M REMOTERGB IP44	4099854449055	15	-20...+40	220-240	120	50/60	160	15000
NEON DIGITALFLEX 5M REMOTERGB IP44	4099854449079	23	-20...+40	220-240	170	50/60	160	15000

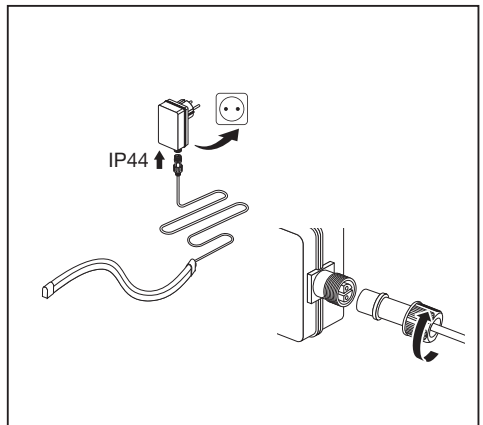
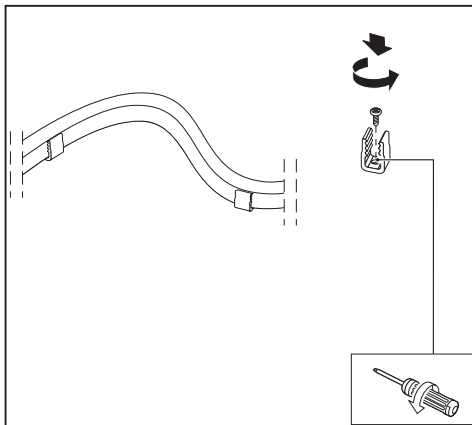
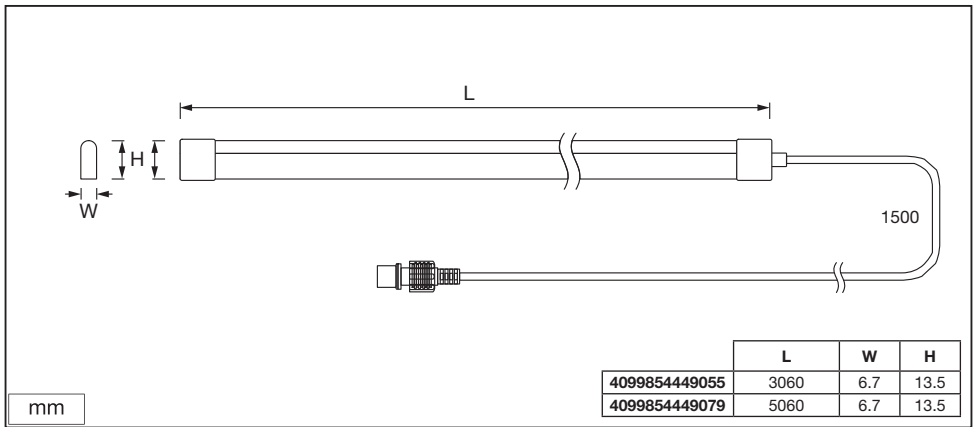
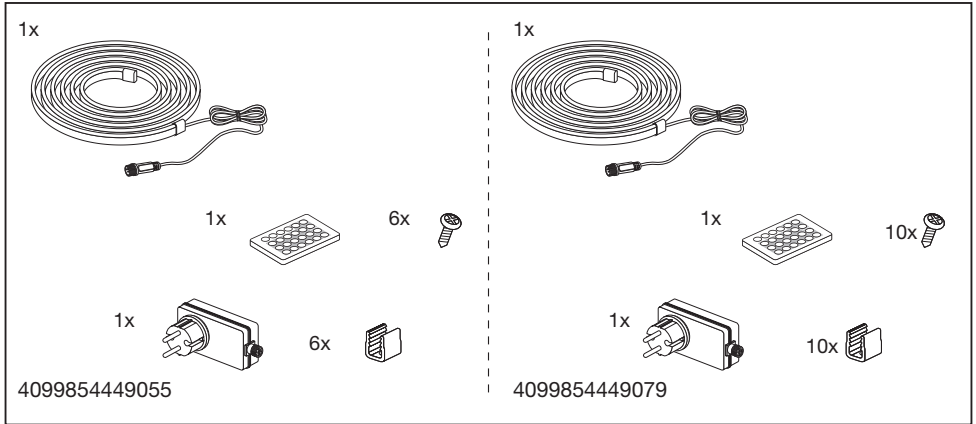

1

Do not connect the rope light to the supply while it is wound onto a reel.¹

2

Do not use the lightstrip when covered or recessed into a surface.²

3







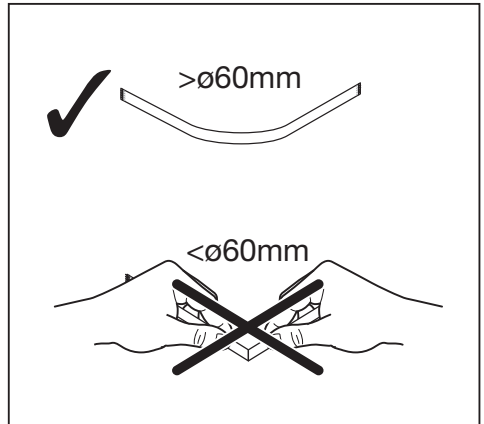
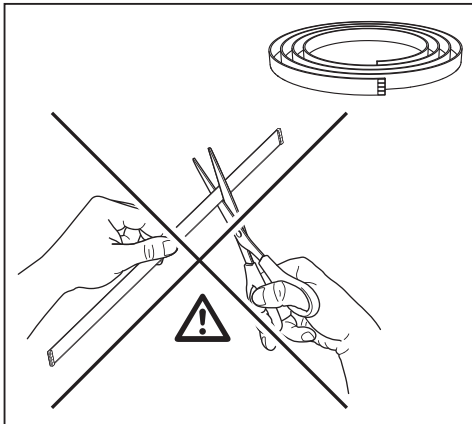





















The string of lights may not be operated within the packaging.³



























4



























Do not open the lightstrip.⁴

























































MAGIC	↑ ↓ w/ww ⏻	AUTO	
*COLOR	IC Set ← → Auto		
3 COLORS	C3 ← → Flash		
7 COLORS	C7 ← → Jump		
16 COLORS	C16 ← → Meteor		

1  Während des Aufwickelns auf die Spule darf der Lichtschlauch nicht an die Stromversorgung angeschlossen werden.  Ne pas brancher le cordon lumineux sur l'alimentation lorsqu'il est enroulé sur une bobine.  Non collegare il cordino luminoso all'alimentazione mentre è avvolto su una bobina.  No conecte la tira luminosa al suministro eléctrico mientras este enrollada en un rollo.  Não ligar o cabo de iluminação à fonte de alimentação enquanto estiver enrolado numa bobina.  Μη συνδέσετε το σχοινί LED στην πηγή ρεύματος ενώ τυλιγμένο σε καρούλι.  De kabellamp niet aan de voeding koppelen als deze op een spoel gewonden is.  Anslut inte slingbelysningen till eluttaget medan den är ihoprullad.  Älä kytke valonauhaa virtalähteeseen silloin, kun se on keilalle kiidottuna.  Ikke koble lysstrimmelen til strøm når den er oppkveilet.  Tilslut ikke lyslängen til strömförsyningen, mens den er rullet op.  Nepripojujte světelný řetěz k napájecímu zdroji, pokud je navinutý na cívice.  Не подключайте намотанный на катушку световой шнур к источнику питания.  Feltekert állapotban ne helyezze áram alá a fényszalagot.  Nie podłączaj lampy wiszące do zasilania, kiedy jest nawinięta na szpulę.  Svetelnú reťaz nepripájajte k napájaniu, kým je zvinutá do cievky.  LED traku ne priključite na napajanje, ko je navita na kolot.  Halat lambasini, bir makaraya sarılı haldeyken elektrik prizeine takmayın.  Nemojte priključiti LED traku na napajanje dok je namotana na kolot.  Nu conectați corpul de iluminat tip bandă la sursa de alimentare în timp ce banda este înfășurată pe o rolă.  Не свързвайте светлинния кабел към захранването, докато е навит на макара.  Äрге ühendage valguskettii vooluvõrku ajal, kui valguskett on poolile keritud.  Nejunkite lempučiuį girliandos prie maitinimo šaltinio, jei ji yra susukta į ritę.  Nepieslēdziet virtenes apgaismojumu pie barošanas avota, kamēr tas ir uzīts uz spoles.  Nemojte da priključite LED traku na napajanje dok je namotana na kolot.  Не під'єднуйте гірлянду до електричної мережі, поки вона намотана на катушку.  Не під'єднуйте світлову стрічку до джерела живлення, поки вона намотана на шпульку.  Жарықты катушкаға жарақат алған кезде қуат көзін қоспаңыз.

2  Lichtleiste nicht verwenden, wenn abgedeckt oder in eine Fläche eingelassen.  Ne pas utiliser le bandeau lumineux s'il est couvert ou en retrait dans un quelconque matériau.  Non utilizzare la striscia luminosa se coperta o incassata in una superficie.  No utilize la línea de luces si está cubierta o incrustada en una superficie.  Não use a fita de luz quando estiver coberta ou embutida numa superfície.  Μην χρησιμοποιείτε τη λωρίδα φωτισμού όταν καλύπτεται ή είναι σε εσοχή μέσα σε επιφάνεια.  Gebruik de lichtketting niet als deze bedekt is of in een oppervlak is verzonken.  Använd inte belysningslängan när den är övertäckt eller på en inskjuten yta.  Älä käytä valonauhaa jos se on peitetty tai upotettu pintaan.  Bruk ikke lysstripen dersom den er tildekket eller felt inn i en overflate.  Lysstrimlen må ikke bruges, når den er tildekket eller forsænket i en overflade.  Světelný pás nepoužívejte zakrytý nebo zapuštěný do povrchu.  Не используйте светодиодную ленту, когда она чем-то закрыта или вмонтирована в поверхность.  Ne használja a fényszalagot letakarva, illetve a felületbe besüllyesztve.  Nie korzystaj z taśmy świetlnej, jeżeli jest przykryta lub wpuszczona w powierzchnię.  Svetelný pás nepoužívejte, ak je zakrytý alebo zapuštěný do povrchu.  Ne uporabljajte svetlobnega traku, če je pokrit ali v utoru v površini.  Isik geridini bir yüzeze örtülmüş ya da gömülmüş ya da şekildedeyken kullanmayın.  Ne upotrebljavajte svetlosnu traku ako je pokrivena ili ulegnuta u površinu.  Nu folosiți banda de leduri dacă este acoperită sau introdusă într-o adâncitură.  Не използвайте светлинната лента, когато е покрита или поставена в прорез на повърхност.  Äрге kasutage valgusriba, kui see on kinni kaetud või süüstatud.  Nenaudokite šviesos juostos, kai ji yra uždengta arba įdėta į paviršių.  Neizmantot gaismas lenti, ja tā ir apsegta vai iegrīmusi virsmā.  Ne koristite svetlosnu traku ako je pokrivena ili ulegnuta u površinu.  Не використовуйте світлодіодну стрічку, коли вона чимось закрыта або вмонтована в поверхню.  Беті жабылган немесе беткі бөлікке ендірілген кезде, жарықтандырылғыш таспаны пайдаланбаңыз.

3  Die Lichterkette darf nicht in der Verpackung betrieben werden.  Le bandeau lumineux ne doit pas être mis en fonction alors qu'il se trouve dans son emballage.  La serie di luci non può essere messa in funzione dall'imballaggio.  La cadena de luces no se puede operar dentro del embalaje.  A grinalda luminosa não pode ser usada dentro da embalagem.  Η σειρά των φωτιστικών δεν πρέπει να χρησιμοποιείται εάν είναι μέσα στη συσκευασία.  De striplamp mag niet in de verpakking worden gebruikt.  Lysrøret får inte användas inuti förpackningen.  Valonauhaa ei saa käyttää pakettin sisällä.  Lyskjeden får ikke brukes mens den fortsatt befinner seg i emballasjen.  Lyskæden må ikke være i drift, men den er i emballagen.  Světelný pás nesmí být používán ve svém obalu.  Запрещается включать гирианду внутри упаковки.  A fényfűzér nem szabad a csomagolásban használni.  Paska švietlnego nie można używać, gdy jest w opakowaniu.  Svetelný pás nesmie používať v obale.  Svetlobne verige ni dovoljeno uporabljati v embalaži.  Noel işiklan ambalaj içinde kullanılmaz.  Svetlosni lanac ne smije se pokretati dok se nalazi u pakiranju.  Rețeaua de lumini nu poate fi acționată în interiorul ambalajului.  Сьс светлинните гирианди не може да се работи, докато са в опаковката.  Valguskettii ei tohi kasutada, kui see asub pakendis.  Šviesos juostų negalima naudoti, kol jos yra pakuotėje.  Gaismu virteni nav atļauts darbināt, kamēr virtene atrodas iepakojumā.  Svetlosni lanac ne sme da se pušta u rad dok se nalazi u pakovanju.  Светлодіодну стрічку не можна використовувати, якщо вона перебуває в упаковці.  Шамдар желісі қаптаманың ішінде жұмыс жасамауы мүмкін.

4  Lichtleiste nicht öffnen.  Ne pas ouvrir le bandeau lumineux.  Non aprire la striscia luminosa.  No abra la línea de luces.  Não abrir a fita de luz.  Μην ανοίξετε τη λωρίδα φωτός.  Open de lichtketting niet.  Öppna inte ljuslisen.  Älä avaa valonauhaa.  Äpne ikke lysstripen.  Lysstrimlen må ikke åbnes.  Světelný pás neotvírejte.  Светодиодную ленту нельзя вскрывать.  Ne nyissa fel a fényszalagot.  Nie otwieraj paska świetlnego.  Svetelný pás neotvárajte.  Svetlobnega traku ne odpirajte.  Isik geridini açmayın.  Ne otvarajte svetlosnu traku.  Nu desfaceți banda LED.  Не отворяйте светлинната лента.  Äрге avage valgusriba.  Neatdirgukite šviesos juostos.  Neatveriet gaismas lenti.  Не отворяйте светлосну траку.  Светлодіодну стрічку не можна розкривати.  Жарық жолақтарын ашпаңыз.

*  Farbe  couleur  colore  color  cor  χρώμα  kleur  färg  väri  farge  farve  barva  farba  цвет  szín  kolor  langva  tringa  boja  culoare  цыят  värv  spalva  krása  boja  колір  түсі



Points de collecte sur www.quefairedemesdechets.fr



LEDVANCE SASU
CQM, 5 rue d'Altorf
67120 Molsheim France
www.ledvance.com

© LEDVANCE Ltd, Sterling House,
810 Mandarin Court, Warrington,
Cheshire, WA1 1GG, United Kingdom

G11235197
08.07.2025