

SKV 7

Cable gland, polyamide

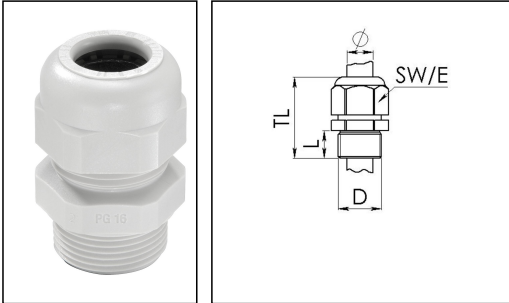

Product illustrations are exemplary and may differ from the chosen product. Further variants and individual customization, we will gladly provide you on request.



Material cable gland	Polyamide
Material sealing gasket	EPDM
Temp. range min	-40 °C
Temp. range max	100 °C
Protection class	IP68 (5 bar 30 min)
Thread type	PG
Ø Connection thread D	7
Length screw-in thread L	9 mm
Ø cable diameter min	3 mm
Ø cable diameter max	6 mm
Key width SW	15 mm
Collar diameter (E)	16 mm
Total length TL	28 mm - 32 mm
Glow wire test	750 °C
Type of cable anchorage	A
Product Color	RAL 7035
Order no. RAL 7035	10066400
Type	SKV 7
Packing unit	50
ETIM-Classification	EC000441

Recommended accessories

MUG 7

10060670

ADR 7

10061419

BS 6

10064004

22.08.2016

