

EMSKV-L 16

Cable gland, brass nickel-plated, M16, with long thread

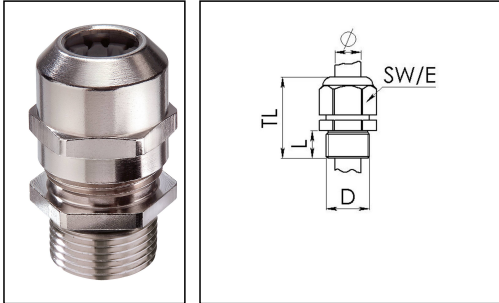

Products may differ in size, colour and appearance to those shown. If you require further information or customisation, please contact us directly.



Material cable gland	Brass nickel-plated
Material clamping cage	Polyamide
Material sealing gasket	EPDM
Temp. range min	-40 °C
Temp. range max	100 °C
Protection class	IP69, IP68 (5 bar 30 min)
Thread type	M
Ø Connection thread D	16
Lead	1,5
Length screw-in thread L	12 mm
Ø cable diameter min	4,5 mm
Ø cable diameter max	10 mm
Key width SW	20 mm
Collar diameter (E)	22 mm
Total length TL	33 mm - 41 mm
Type of cable anchorage	A
Install. torques fitting	4 N m
Install. torques cap nut	4 N m
Impact category	6
Surface	Nickel-plated
Order no. nickel-plated	10065009
Packing unit	50
Type	EMSKV-L 16
Tariff number	74198090
EAN number	4007685650090

Your Contact:

WISKA Hoppmann GmbH

Kisdorfer Weg 28 · 24568 Kaltenkirchen · Germany

☎ +49-4191-508-0 · 📠 +49-4191-508-209

contact@wiska.de · www.wiska.com

ETIM-Classification

EC000441

Recommended accessories

RDE 16	10062184
EMMU 16	10063142
BS 10	10064008
MFD 16/02/040	10064393
MFD 16/03/021	10101014

17.02.2026

Your Contact:

WISKA Hoppmann GmbH

Kisdorfer Weg 28 · 24568 Kaltenkirchen · Germany

☎ +49-4191-508-0 · 📠 +49-4191-508-209

contact@wiska.de · www.wiska.com



Your Contact:

WISKA Hoppmann GmbH

Kisdorfer Weg 28 · 24568 Kaltenkirchen · Germany

☎ +49-4191-508-0 · 📠 +49-4191-508-209

contact@wiska.de · www.wiska.com