

EMSKV 25 EMV-S

EMC-cable gland, brass nickel-plated with short thread, M25

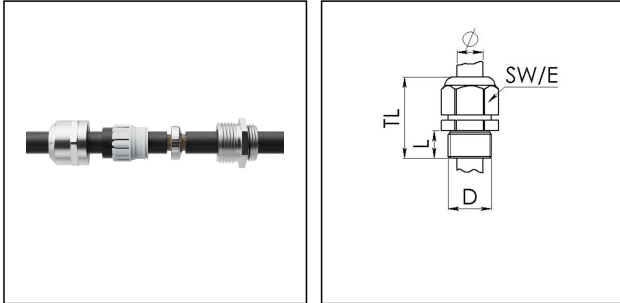

Products may differ in size, colour and appearance to those shown. If you require further information or customisation, please contact us directly.



Material cable gland	Brass nickel-plated
Material sealing gasket	EPDM
Material clamping cage	Polyamide
Material earthing insert	Stainless steel 1.4310
Temp. range min	-40 °C
Temp. range max	100 °C
Protection class	IP69, IP68 (5 bar 30 min)
Thread type	M
Ø Connection thread D	25
Lead	1,5
Length screw-in thread L	7 mm
Ø cable diameter min	9 mm
Ø cable diameter max	17 mm
Cable Ø shield external	7,5 mm - 13,5 mm
Key width SW	29 mm
Collar diameter (E)	32 mm
Total length TL	33 mm - 42 mm
Type of cable anchorage	A
Install. torques cap nut	10 N m
Install. torques fitting	10 N m
Impact category	6
Surface	Nickel-plated
Order no. nickel-plated	10102276
Type	EMSKV 25 EMV-S
Packing unit	50

Your Contact:

WISKA Hoppmann GmbH

Kisdorfer Weg 28 · 24568 Kaltenkirchen · Germany

☎ +49-4191-508-0 · 📠 +49-4191-508-209

contact@wiska.de · www.wiska.com

Tariff number	85369010
EAN number	4007685046442
ETIM-Classification	EC000441

Recommended accessories

RDE 25	10060768
EMMU-EMV 25	10063213
BS 17	10064012

17.02.2026

Your Contact:

WISKA Hoppmann GmbH

Kisdorfer Weg 28 · 24568 Kaltenkirchen · Germany

☎ +49-4191-508-0 · 📠 +49-4191-508-209

contact@wiska.de · www.wiska.com



Your Contact:

WISKA Hoppmann GmbH

Kisdorfer Weg 28 · 24568 Kaltenkirchen · Germany

☎ +49-4191-508-0 · 📠 +49-4191-508-209

contact@wiska.de · www.wiska.com