

EMMU 16

Locknut, brass

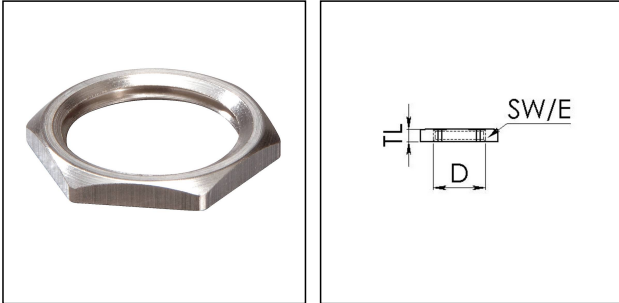

Product illustrations are exemplary and may differ from the chosen product. Further variants and individual customization, we will gladly provide you on request.



Material	Brass nickel-plated
Surface	Nickel-plated
Temp. range min	-200 °C
Temp. range max	250 °C
Thread type	M
Ø Connection thread D	16
Lead	1,5
Key width SW	19 mm
Collar diameter (E)	21 mm
Total length TL	2,8 mm
Order no. nickel-plated	10063142
Type	EMMU 16
Packing unit	100
ETIM-Classification	EC000940

23.08.2016

