

EMMU 25

Locknut, brass

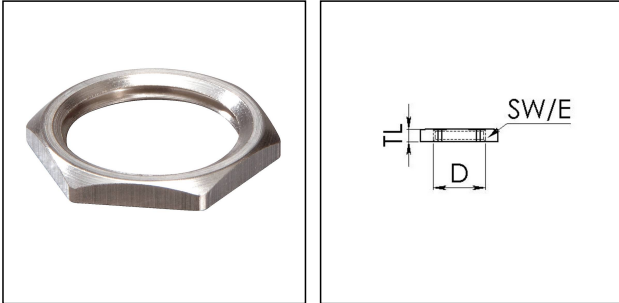

Product illustrations are exemplary and may differ from the chosen product. Further variants and individual customization, we will gladly provide you on request.



Material	Brass nickel-plated
Surface	Nickel-plated
Temp. range min	-200 °C
Temp. range max	250 °C
Thread type	M
Ø Connection thread D	25
Lead	1,5
Key width SW	30 mm
Collar diameter (E)	34 mm
Total length TL	3,5 mm
Order no. nickel-plated	10063144
Type	EMMU 25
Packing unit	100
ETIM-Classification	EC000940

23.08.2016

