

EMMU 63

Locknut, brass

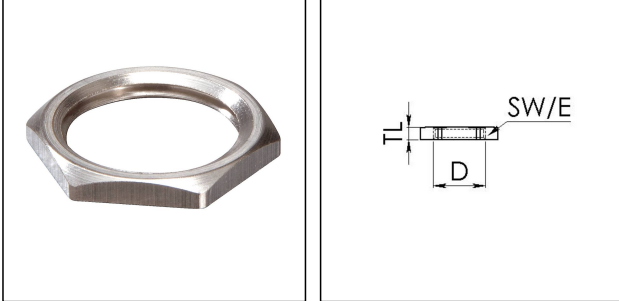

Product illustrations are exemplary and may differ from the chosen product. Further variants and individual customization, we will gladly provide you on request.



Material	Brass nickel-plated
Surface	Nickel-plated
Temp. range min	-200 °C
Temp. range max	250 °C
Thread type	M
Ø Connection thread D	63
Lead	1,5
Key width SW	70 mm
Collar diameter (E)	75 mm
Total length TL	6 mm
Order no. nickel-plated	10063148
Type	EMMU 63
Packing unit	50
ETIM-Classification	EC000940

23.08.2016

