

## EMMU 50

Locknut, brass

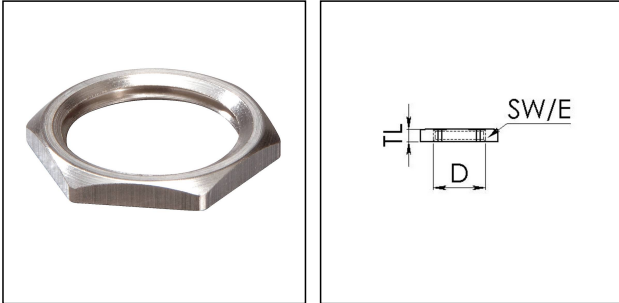

Product illustrations are exemplary and may differ from the chosen product. Further variants and individual customization, we will gladly provide you on request.



<b>Material</b>	Brass nickel-plated
<b>Surface</b>	Nickel-plated
<b>Temp. range min</b>	-200 °C
<b>Temp. range max</b>	250 °C
<b>Thread type</b>	M
<b>Ø Connection thread D</b>	50
<b>Lead</b>	1,5
<b>Key width SW</b>	60 mm
<b>Collar diameter (E)</b>	65 mm
<b>Total length TL</b>	5 mm
<b>Order no. nickel-plated</b>	10063147
<b>Type</b>	EMMU 50
<b>Packing unit</b>	50
<b>ETIM-Classification</b>	EC000940

23.08.2016

