

## ESKV-RDE 32 LG

Cable gland with reduction sealing insert, polyamide, M32, RAL 7035

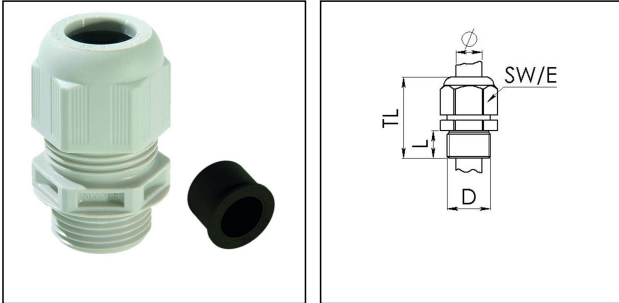

Products may differ in size, colour and appearance to those shown. If you require further information or customisation, please contact us directly.



|                                      |                           |
|--------------------------------------|---------------------------|
| <b>Material cable gland</b>          | Polyamide                 |
| <b>Material sealing gasket</b>       | EPDM                      |
| <b>Protection class</b>              | IP69, IP68 (5 bar 30 min) |
| <b>Temp. range min</b>               | -40 °C                    |
| <b>Temp. range max</b>               | 100 °C                    |
| <b>Glow wire test</b>                | 750 °C                    |
| <b>Thread type</b>                   | M                         |
| <b>Ø Connection thread D</b>         | 32                        |
| <b>Lead</b>                          | 1,5                       |
| <b>Length screw-in thread L</b>      | 12 mm                     |
| <b>Ø cable diameter min</b>          | 9 mm                      |
| <b>Ø cable diameter max</b>          | 21 mm                     |
| <b>Key width SW</b>                  | 36 mm                     |
| <b>Collar diameter (E)</b>           | 40 mm                     |
| <b>Total length TL</b>               | 42 mm - 51 mm             |
| <b>Type of cable anchorage</b>       | A                         |
| <b>Install. torques fitting</b>      | 15 N m                    |
| <b>Install. torques fitting/EADR</b> | 4 N m                     |
| <b>Install. torques cap nut</b>      | 4 N m                     |
| <b>Impact category</b>               | 4                         |
| <b>Advice</b>                        | With reduction insert     |
| <b>Product Color</b>                 | RAL 7035                  |
| <b>Type</b>                          | ESKV-RDE 32 LG            |
| <b>Order no. RAL 7035</b>            | 10064980                  |
| <b>Packing unit</b>                  | 25                        |

Your Contact:

WISKA Hoppmann GmbH

Kisdorfer Weg 28 · 24568 Kaltenkirchen · Germany

☎ +49-4191-508-0 · 📠 +49-4191-508-209

contact@wiska.de · www.wiska.com

|                            |               |
|----------------------------|---------------|
| <b>EAN number</b>          | 4007685649803 |
| <b>Tariff number</b>       | 39269097      |
| <b>ETIM-Classification</b> | EC000441      |

#### Recommended accessories

|                   |          |
|-------------------|----------|
| <b>EMUG 32 LG</b> | 10060774 |
| <b>EADR 32</b>    | 10062805 |
| <b>BS 14</b>      | 10064011 |

08.05.2025

Your Contact:

**WISKA Hoppmann GmbH**

Kisdorfer Weg 28 · 24568 Kaltenkirchen · Germany

☎ +49-4191-508-0 · 📠 +49-4191-508-209

contact@wiska.de · www.wiska.com



Your Contact:

**WISKA Hoppmann GmbH**

Kisdorfer Weg 28 · 24568 Kaltenkirchen · Germany

☎ +49-4191-508-0 · 📠 +49-4191-508-209

contact@wiska.de · www.wiska.com