

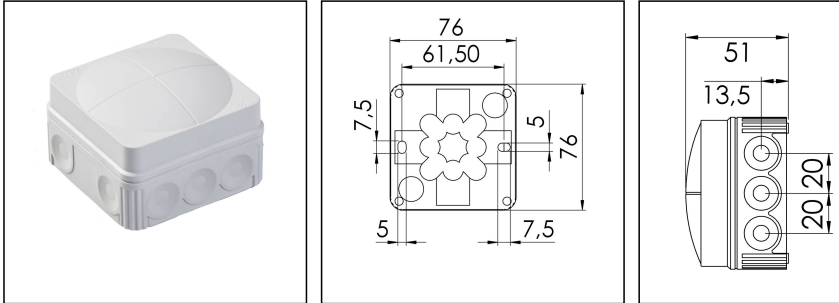

COMBI 108/5

Junction box, polypropylene



Product illustrations are exemplary and may differ from the chosen product. Further variants and individual customization, we will gladly provide you on request.



Material	Polypropylene
Material sealing gasket	TPE
Temp. range min	-30 °C
Temp. range max	100 °C
Temperatures during install.	-5 °C - 60 °C
Protection class	IP66
Glow wire test	750 °C
Voltage	400 V
Terminals/poles	2,5 mm ²
Terminals/poles	5 x 2,5mm ²
Fixing	2 internal openings
Ø cable diameter min	3 mm
Ø cable diameter max	14 mm
External dimensions LxWxH	76 x 76 x 51mm
Using for cable gland	
Product Color	RAL 7035
WISKA-Order no.	10060523
Type	COMBI 108/5
Packing unit	10
ETIM-Classification	EC002600

Remarks:

Fixing: By mounting clip or two internal openings outside of the sealing area

Equipment: 10 elastic self-sealing puncture-membranes for cable entry on the side and 2 in the bottom inclusive terminal block 5-poles, 2,5mm²

Recommended accessories

SMB 108

10060528

Spare parts

SP-HKT 11/5 Terminal block

22000406

23.08.2016

