

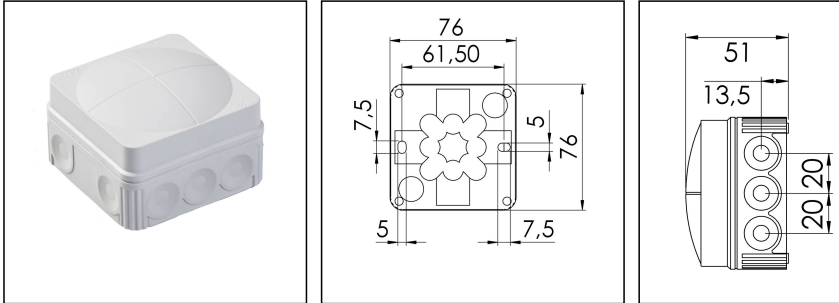

## COMBI 108/empty/W

Junction box, polypropylene



Product illustrations are exemplary and may differ from the chosen product. Further variants and individual customization, we will gladly provide you on request.



<b>Material</b>	Polypropylene
<b>Material sealing gasket</b>	TPE
<b>Temp. range min</b>	-30 °C
<b>Temp. range max</b>	100 °C
<b>Temperatures during install.</b>	-5 °C - 60 °C
<b>Protection class</b>	IP66
<b>Glow wire test</b>	750 °C
<b>Voltage</b>	400 V
<b>Terminals/poles</b>	2,5 mm <sup>2</sup>
<b>Fixing</b>	2 internal openings
<b>Ø cable diameter min</b>	3 mm
<b>Ø cable diameter max</b>	14 mm
<b>External dimensions LxWxH</b>	76 x 76 x 51mm
<b>Using for cable gland</b>	
<b>Product Color</b>	RAL 9001
<b>WISKA-Order no.</b>	10060622
<b>Type</b>	COMBI 108/empty/W
<b>Packing unit</b>	10
<b>ETIM-Classification</b>	EC002600

Remarks:

Fixing: By mounting clip or two internal openings outside of the sealing area

Equipment: 10 elastic self-sealing puncture-membranes for cable entry on the side and 2 in the bottom

Recommended accessories

<b>DIN Rail Kit - COMBI 108 / 308</b>	10060362
<b>SMB 108</b>	10060528
<b>SP-HKT 11/5 Terminal block</b>	22000406

23.08.2016

