

Driver LC 18W 24V SR SNC

essence series 24 V – not dimmable (IP20)

**Product description**

- _ Independent constant voltage LED driver
- _ Output voltage 24 V
- _ Max. output power 18 W
- _ Dimmable via external PWM LED dimmers attached on output side
- _ In the single packaging (SP) each Driver has also an individual packaging
- _ Nominal lifetime up to 50,000 h
- _ 5 years guarantee (conditions at <https://www.tridonic.com/en/int/services/manufacturer-guarantee-conditions>)

Typical applications

- _ Cove lighting, facade accent lighting, ceiling integration

Technical details

- _ 24 V, 18 W
- _ Small design (127 x 43 x 30 mm)
- _ Output LF voltage ripple (< 120 Hz) $\pm 1.5\%$
- _ Small cross section
- _ Push terminals for simple wiring

System solution

- _ Tridonic LLE-FLEX EXC 600, 1,200, 1,800, 2,500 lm/m
- _ Tridonic LLE-FLEX ADV G2 600, 1,200, 1,800 lm/m
- _ Tridonic LLE-FLEX SNC 600, 1,200, 1,800 lm/m
- _ In connection with Flex accessories wire to PCB plug

Website

<http://www.tridonic.com/87500931>

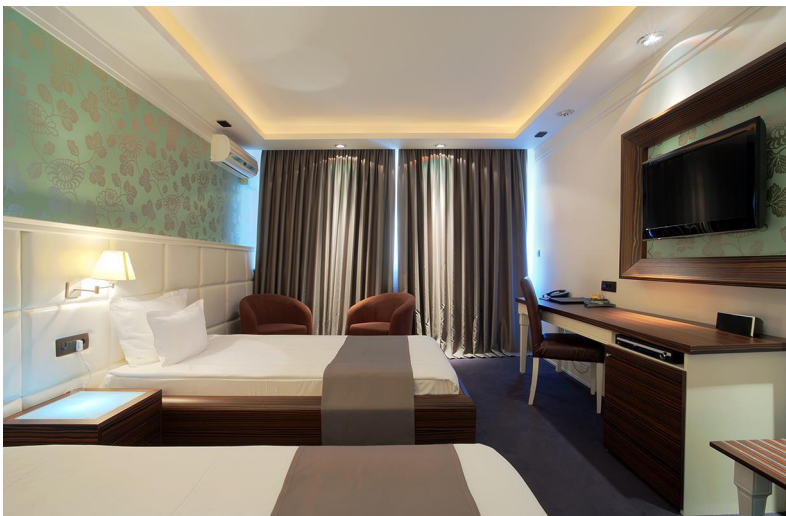

Linear



High bay



Decorative



Downlights



Spotlights



Free-standing



Area



Floor | Wall



Street

Driver LC 18W 24V SR SNC

essence series 24 V – not dimmable (IP20)

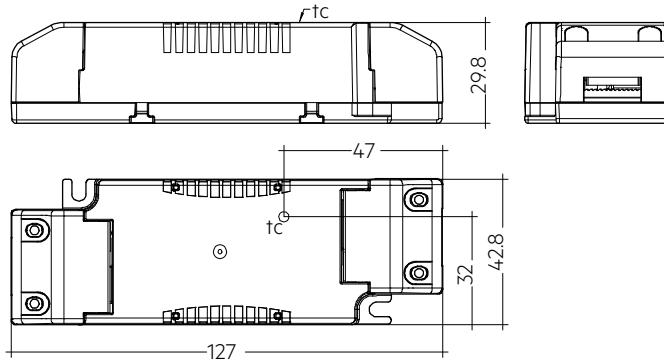
**Ordering data**

Type	Article number	Packaging, carton	Packaging, pallet	Packaging, high volume	Weight per pc.
Multi packaging					
LC 18W 24V SR SNC	87500931	49 pc(s).	686 pc(s).	3,430 pc(s).	0.092 kg
Single packaging					
LC 18W 24V SR SNC SP	87500932	20 pc(s).	480 pc(s).	2,400 pc(s).	0.092 kg

Technical data

Rated supply voltage	220 – 240 V
AC voltage range	198 – 264 V
Mains frequency	50 / 60 Hz
Overvoltage protection	320 V AC, 1 h
Typ. rated current (at 230 V, 50 Hz, full load) ^①	95 mA
Max. input power	22 W
Typ. efficiency (at 230 V, 50 Hz, full load)	86 %
λ (at 230 V, 50 Hz, full load) ^①	0.95
Typ. input current in no-load operation	25 mA
Typ. input power in no-load operation	0.3 W
In-rush current (peak / duration)	8 A / 350 μ s
THD (at 230 V, 50 Hz, full load) ^①	< 10 %
Output P _{ST_LM} (at full load)	≤ 1
Output SVM (at full load)	≤ 0.4
Starting time (at 230 V, 50 Hz, full load) ^①	< 0.5 s
Turn off time (at 230 V, 50 Hz, full load)	< 0.2 s
Hold on time at power failure (output)	0 s
Output voltage tolerance	± 1 V
Output LF voltage ripple (< 120 Hz)	± 1.5 %
Max. output voltage (U-OUT)	25 V
Burst capability	1 kV
Mains surge capability (between L - N)	1 kV
Mains surge capability (between L/N - PE)	2 kV
Type of protection	IP20
Lifetime	up to 50,000 h
Guarantee (conditions at www.tridonic.com)	5 Year(s)
Dimensions L x W x H	127 x 43 x 30 mm

Approval marks**Standards**

EN 55015, EN 61000-3-2, EN 61000-3-3, EN 61347-1, EN 61347-2-13, EN 62384, EN 61547, EN 60598-1

Specific technical data

Type	Load	Output voltage	Output current	Max. output power	Typ. power consumption	Typ. current consumption	t _c point max.	Ambient temperature t _a
LC 18W 24V SR SNC	30 %	24 V	225 mA	5.4 W	6.5 W	41 mA	65 °C	-25 ... +50 °C
LC 18W 24V SR SNC	40 %	24 V	300 mA	7.2 W	8.4 W	47 mA	65 °C	-25 ... +50 °C
LC 18W 24V SR SNC	50 %	24 V	375 mA	9.0 W	10.4 W	54 mA	65 °C	-25 ... +50 °C
LC 18W 24V SR SNC	60 %	24 V	450 mA	10.8 W	12.5 W	61 mA	65 °C	-25 ... +50 °C
LC 18W 24V SR SNC	70 %	24 V	525 mA	12.6 W	14.5 W	69 mA	65 °C	-25 ... +50 °C
LC 18W 24V SR SNC	80 %	24 V	600 mA	14.4 W	16.5 W	77 mA	65 °C	-25 ... +50 °C
LC 18W 24V SR SNC	90 %	24 V	675 mA	16.2 W	18.5 W	84 mA	65 °C	-25 ... +50 °C
LC 18W 24V SR SNC	100 %	24 V	750 mA	18.0 W	20.5 W	95 mA	65 °C	-25 ... +50 °C
LC 18W 24V SR SNC SP	30 %	24 V	225 mA	5.4 W	6.5 W	41 mA	65 °C	-25 ... +50 °C
LC 18W 24V SR SNC SP	40 %	24 V	300 mA	7.2 W	8.4 W	47 mA	65 °C	-25 ... +50 °C
LC 18W 24V SR SNC SP	50 %	24 V	375 mA	9.0 W	10.4 W	54 mA	65 °C	-25 ... +50 °C
LC 18W 24V SR SNC SP	60 %	24 V	450 mA	10.8 W	12.5 W	61 mA	65 °C	-25 ... +50 °C
LC 18W 24V SR SNC SP	70 %	24 V	525 mA	12.6 W	14.5 W	69 mA	65 °C	-25 ... +50 °C
LC 18W 24V SR SNC SP	80 %	24 V	600 mA	14.4 W	16.5 W	77 mA	65 °C	-25 ... +50 °C
LC 18W 24V SR SNC SP	90 %	24 V	675 mA	16.2 W	18.5 W	84 mA	65 °C	-25 ... +50 °C
LC 18W 24V SR SNC SP	100 %	24 V	750 mA	18.0 W	20.5 W	95 mA	65 °C	-25 ... +50 °C

① Valid at 100 % dimming level.

1. Standards

EN 55015
 EN 61000-3-2
 EN 61000-3-3
 EN 61347-1
 EN 61347-2-13
 EN 62384
 EN 61547
 EN 60598-1

1.1 Glow wire test

according to EN 61347-1 with increased temperature of 850 °C passed.

2. Thermal details and lifetime

2.1 Expected lifetime

Expected lifetime			
Type	ta	40 °C	50 °C
LC 18W 24V SR SNC	tc	55 °C	65 °C
	Lifetime	50,000 h	30,000 h

The LED control gear is designed for a lifetime stated above under reference conditions and with a failure probability of less than 10 %. The relation of tc to ta temperature depends also on the luminaire design. If the measured tc temperature is approx. 5 K below tc max., ta temperature should be checked and eventually critical components (e.g. ELCAP) measured. Detailed information on request.

3. Installation / wiring

3.1 Circuit diagram

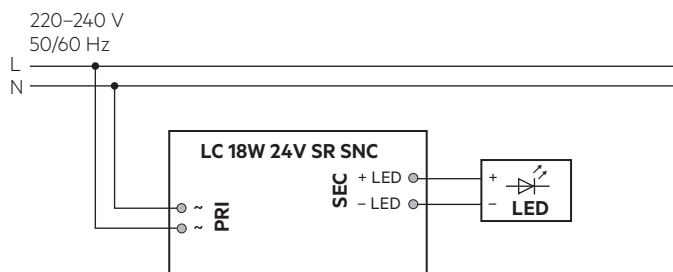

Recommendation to check glowing at standby in combination with class I luminaires.

3.2 Wiring type and cross section

For wiring use stranded wire with ferrules or solid wire from 0.75–1.5 mm² (mains wires) and 0.2–1.5 mm² (secondary wires, LED module). Strip 8.5–9.5 mm of insulation from the cables to ensure perfect operation of the push-wire terminals.

Use one wire for each terminal connector only.

The max. torque at the clamping screw (M3) is 0.3 Nm.

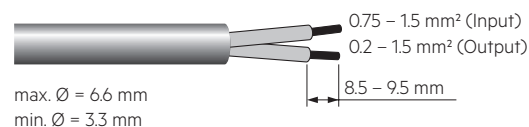

3.3 Loose wiring

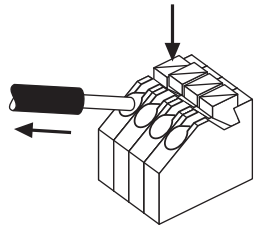

Release of the wiring

Press down the "push button" and remove the cable from front.

3.4 Fixing conditions when using as independent Driver with Clip-On

Dry, acidfree, oilfree, fatfree. It is not allowed to exceed the maximum ambient temperature (t_a) stated on the device. Minimum distances stated below are recommendations and depend on the actual luminaire. Is not suitable for fixing in corner.

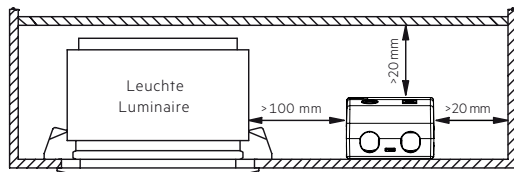

Device not suitable for covering with thermally insulating material according to IEC 60598-1 Ed.9

3.5 Wiring guidelines

- The cables should be run separately from the mains connections and mains cables to ensure good EMC conditions.
- The LED wiring should be kept as short as possible to ensure good EMC. The typical secondary cable length is 0.8 m (1.6 m circuit).
- To comply with the EMC regulations run the secondary wires (LED module) in parallel.
- The LED driver has no inverse-polarity protection on the secondary side. Wrong polarity can damage LED modules with no inverse-polarity protection.
- Wrong wiring of the LED driver can lead to malfunction or irreparable damage.
- To avoid damage of the Driver, the wiring must be protected against short circuits to earth (sharp edged metal parts, metal cable clips, louver, etc.).

3.6 Installation instructions

The LED module and all contact points within the wiring must be sufficiently insulated against 3 kV surge voltage. Air and creepage distance must be maintained.

3.7 Mounting of device

Max. torque for fixing: 0.5 Nm/M4

4. Electrical values

4.1 Efficiency vs. load

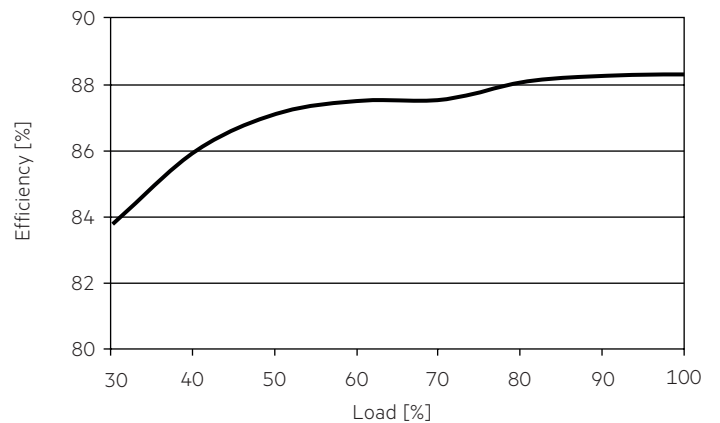

4.2 Power factor vs. Load

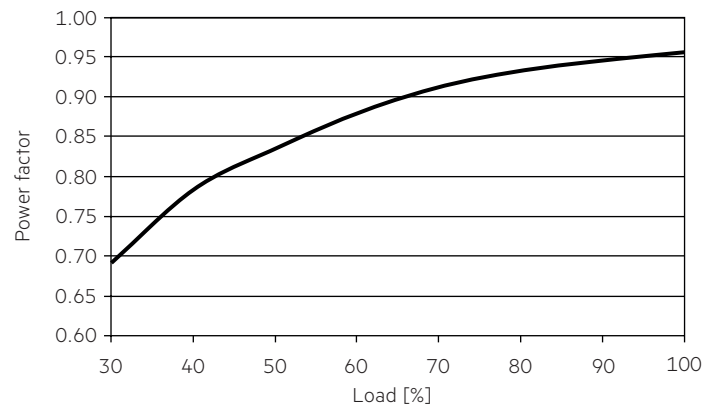

4.3 Input power vs. Load

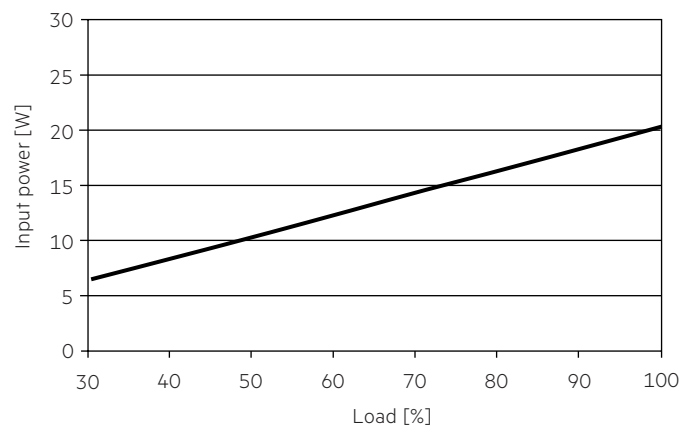

4.4 Input current vs. Load

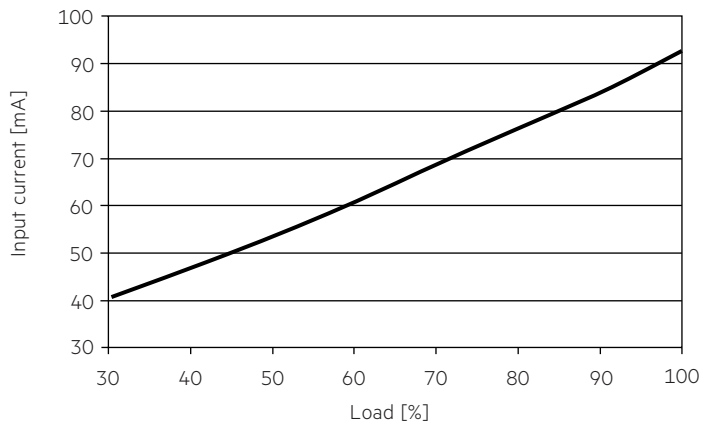

4.5 THD vs. Load

THD without harmonic < 5 mA (0.6 %) of the input current:

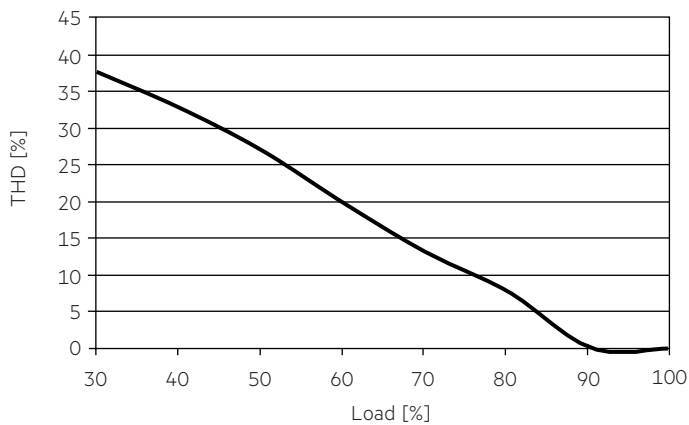

4.6 Maximum loading of automatic circuit breakers in relation to inrush current

Automatic circuit breaker type	C10	C13	C16	C20	B10	B13	B16	B20	Inrush current	
Installation Ø	1.5 mm ²	1.5 mm ²	1.5 mm ²	2.5 mm ²	1.5 mm ²	1.5 mm ²	1.5 mm ²	2.5 mm ²	I _{max}	time
LC 18W 24V SR SNC	38	50	60	71	23	30	36	43	8 A	350 µs

These are max. values calculated out of inrush current! Please consider not to exceed the maximum rated continuous current of the circuit breaker.

Calculation uses typical values from ABB series S200 as a reference.

Actual values may differ due to used circuit breaker types and installation environment.

4.7 Harmonic distortion in the mains supply (at 230 V / 50 Hz and full load) in %

	THD	3.	5.	7.	9.	11.
LC 18W 24V SR SNC	< 10	< 6	< 4	< 3	< 3	< 3

Acc. to 61000-3-2. Harmonics < 5 mA or < 0.6 % (whatever is greater) of the input current are not considered for calculation of THD.

5. Functions

5.1 Overload protection

If the maximum load is exceeded by a defined internal limit, the LED will flicker, and output voltage will be reduced. When fault is removed, the driver can go back to work automatically without resetting input main power.

5.2 Overtemperature protection

The LED driver is protected against temporary thermal overheating. If the temperature limit is exceeded the LED will switch off and restart automatically after the driver cold down. The temperature protection is activated approx. + 20 °C above T_c max.

5.3 Short-circuit behaviour

In case of a short circuit at the LED output the LED output is switched off. When fault is removed, the driver can go back to work automatically without resetting input main power.

5.4 No-load operation

The LED driver will not be damaged in the no-load operation. When the output is floating and doesn't connect the LED modules, the output voltage will keep the max. voltage (< 25 V). After connecting the LED load, the driver works normally without resetting the main power.

5.5 Hot plug-in

Hot plug-in is supported. If a LED load is connected, the device does not need to be restarted before the output will be activated again.

6. Miscellaneous

6.1 Insulation and electric strength testing of luminaires

Electronic devices can be damaged by high voltage. This has to be considered during the routine testing of the luminaires in production.

According to IEC 60598-1 Annex Q (informative only!) or ENEC 303-Annex A, each luminaire should be submitted to an insulation test with 500 V_{DC} for 1 second. This test voltage should be connected between the interconnected phase and neutral terminals and the earth terminal. The insulation resistance must be at least 2 MΩ.

As an alternative, IEC 60598-1 Annex Q describes a test of the electrical strength with 1500 V_{AC} (or 1.414 x 1500 V_{DC}). To avoid damage to the electronic devices this test must not be conducted.

6.2 Conditions of use and storage

Humidity: 5% up to max. 85%,
not condensed
(max. 56 days/year at 85%)

Storage temperature: -40 °C up to max. +80 °C

The devices have to be acclimatised to the specified temperature range (ta) before they can be operated.

6.3 Maximum number of switching cycles

All LED driver are tested with 50,000 switching cycles.

6.4 Additional information

Additional technical information at www.tridonic.com → Technical Data

Lifetime declarations are informative and represent no warranty claim. No warranty if device was opened.