

## Driver LC 75W 350-500mA 167V flexC Ip SNC4

essence series

**Product description**

- \_ LED Constant current LED driver for luminaire installation
- \_ For class I luminaires
- \_ Temperature protection as per EN 61347-2-13 C5e
- \_ Selectable fixed output current 350, 400, 450 and 500 mA (pre-selected current 500 mA)
- \_ Max. output power 75.2 W
- \_ Up to 94 % efficiency
- \_ Nominal lifetime up to 100,000 h
- \_ 5 years guarantee (conditions at <https://www.tridonic.com/en/int/services/manufacturer-guarantee-conditions>)

**Housing properties**

- \_ Casing: metal, white
- \_ Type of protection IP20

**Functions**

- \_ Overload protection
- \_ Short-circuit protection
- \_ No-load protection
- \_ Overtemperature protection

**Website**

<http://www.tridonic.com/8750117>



Linear



High bay



Decorative



Downlights



Spotlights



Free-standing



Area



Floor | Wall



Street

## Driver LC 75W 350-500mA 167V flexC Ip SNC4

essence series

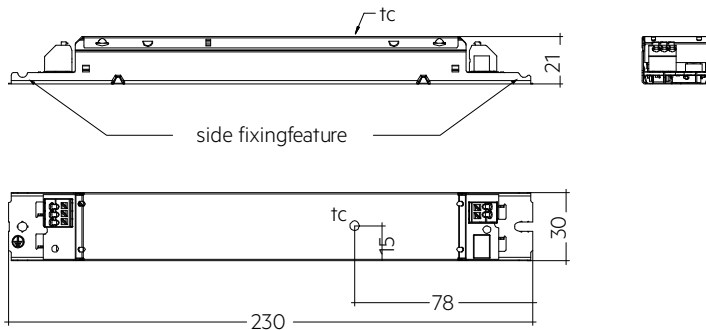

## Ordering data

Type	Article number	Packaging, carton	Packaging, low volume	Packaging, high volume	Weight per pc.
LC 75/350-500/167 flexC Ip SNC4	87501117	50 pc(s).	900 pc(s).	2,700 pc(s).	0.15 kg

## Technical data

Rated supply voltage	220 – 240 V
AC voltage range	198 – 264 V
DC voltage range	176 – 280 V
Max. input current (at 230 V, 50 Hz, full load) <sup>①</sup>	360 mA
Typ. current (220 V, 0 Hz, full load, EOFx dimlevel)	390 mA
Leakage current (at 230 V, 50 Hz, full load)	< 450 µA
Mains frequency	0 / 50 / 60 Hz
Overvoltage protection	320 V AC, 48 h
Output power range	24.5 – 75.2 W
Typ. efficiency (at 230 V, 50 Hz, full load) <sup>①</sup>	94 %
λ (at 230 V, 50 Hz, full load) <sup>①</sup>	0.98
Output current tolerance <sup>②</sup>	± 7.5 %
Max. output voltage (U-OUT)	300 V
THD (at 230 V, 50 Hz, full load) <sup>①</sup>	< 10 %
Max. peak output current at full load <sup>①</sup>	564 mA
Output LF current ripple (< 120 Hz)	± 5 %
Output P_ST_LM (at full load)	≤ 1
Output SVM (at full load)	≤ 0.4
Starting time (at 230 V, 50 Hz, full load)	≤ 0.5 s
Starting time (DC mode)	≤ 0.5 s
Switchover time (AC/DC)	≤ 0.5 s
Turn off time (at 230 V, 50 Hz, full load)	≤ 0.5 s
Hold on time at power failure (output)	0 s
Ambient temperature ta (at lifetime 50,000 h)	60 °C
Storage temperature ts	-40 ... +80 °C
Mains burst capability	1 kV
Mains surge capability (between L - N)	1 kV
Mains surge capability (between L/N - PE)	2 kV
Surge voltage at output side (against PE)	3.5 kV
Lifetime	up to 100,000 h
Guarantee (conditions at www.tridonic.com)	5 Year(s)
Dimensions L x W x H	230 x 30 x 21 mm
Hole spacing D	218 mm

## Approval marks



## Standards

EN 55015, EN 61000-3-2, EN 61000-3-3, EN 61347-1, EN 61347-2-13, EN 61547, EN 62384, according to EN 50172, according to EN 60598-2-22

## Specific technical data

Type	Output current <sup>①</sup>	Min. output voltage	Max. output voltage	Max. output power	Typ. power consumption (at 230 V, 50 Hz, full load)	Typ. current consumption (at 230 V, 50 Hz, full load)	tc point max.	Ambient temperature ta	I-out select
LC 75/350-500/167 flexC Ip SNC4	350 mA	70 V	167 V	58.5 W	78.5 W	270 mA	73 °C	-20 ... +60 °C	1=off / 2=off
LC 75/350-500/167 flexC Ip SNC4	400 mA	70 V	167 V	66.8 W	78.5 W	310 mA	76 °C	-20 ... +60 °C	1=on / 2=off
LC 75/350-500/167 flexC Ip SNC4	450 mA	70 V	167 V	75.2 W	79.5 W	350 mA	78 °C	-20 ... +60 °C	1=off / 2=on
LC 75/350-500/167 flexC Ip SNC4	500 mA	70 V	150 V	75.0 W	80.0 W	360 mA	78 °C	-20 ... +60 °C	1=on / 2=on

① Test result at 500 mA.

② Test result at 25 °C.

③ Output current is mean value.

## 1. Standards

EN 55015  
 EN 61000-3-2  
 EN 61000-3-3  
 EN 61347-1  
 EN 61347-2-13  
 EN 61547  
 EN 62384

According to EN 50172 for use in central battery systems

According to EN 60598-2-22 suitable for emergency lighting installations

## 2. Thermal details and lifetime

### 2.1 Expected lifetime

Expected lifetime					
Type	Output current	ta	50 °C	55 °C	60 °C
LC 75/350-500/167 flexC Ip SNC4	350 mA	tc	63 °C	68 °C	73 °C
		Lifetime	> 100,000 h	90,000 h	70,000 h
	400 mA	tc	66 °C	71 °C	76 °C
		Lifetime	> 100,000 h	90,000 h	60,000 h
	450 mA	tc	68 °C	73 °C	78 °C
		Lifetime	> 100,000 h	70,000 h	50,000 h
	500 mA	tc	68 °C	73 °C	78 °C
		Lifetime	> 100,000 h	70,000 h	50,000 h

The LED driver is designed for a lifetime stated above under reference conditions and with a failure probability of less than 10 %.

The relation of tc to ta temperature depends also on the luminaire design.

If the measured tc temperature is approx. 5 K below tc max., ta temperature should be checked and eventually critical components (e.g. ELCAP) measured.

Detailed information on request.

### 3. Installation / wiring

#### 3.1 Circuit diagram

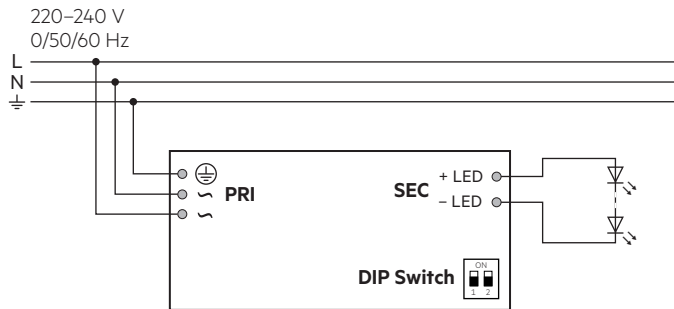

#### 3.2 Wiring type and cross section

For wiring use stranded wire with ferrules or solid wire from 0.5 – 1.5 mm<sup>2</sup>. Strip 8.5 – 9.5 mm of insulation from the cables to ensure perfect operation of the push-wire terminals (WAGO 250).

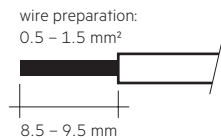

#### 3.3 Release of the wiring

Press down the “push button” and remove the cable from front.

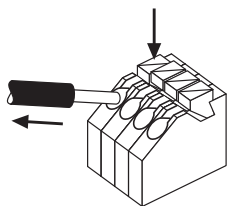

#### 3.4 Wiring guidelines

- All connections must be kept as short as possible to ensure good EMI behaviour.
- Mains leads should be kept apart from LED driver and other leads (ideally 5 – 10 cm distance)
- Max. length of output wires is 2 m.
- Incorrect wiring can damage LED modules.
- To avoid the damage of the Driver, the wiring must be protected against short circuits to earth (sharp edged metal parts, metal cable clips, louver, etc.).

#### 3.5 Earth connection

The earth connection is conducted as protection earth (PE). If the LED Driver will be earthed, protection earth (PE) has to be used. Earth connection is recommended to improve following behaviour:

- Electromagnetic interferences (EMI)
- Transmission of mains transients to the LED output

In general it is recommended to earth the LED driver if the LED module is mounted on earthed luminaire parts respectively heat sinks and thereby representing a high capacity against earth.

#### 3.6 Replace LED module

1. Mains off
2. Remove LED module
3. Wait for 20 seconds
4. Connect LED module again

Hot plug-in or output switching of LEDs is not permitted and may cause a very high current to the LEDs.

#### 3.7 Mounting of device

Max. torque for fixing: 0.5 Nm/M4

#### 3.8 Current setting



Set the current by DIP switch after mains off. Use of DIP switch only after mains off.

**350 mA:** Switch 1 = Off, Switch 2 = Off

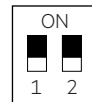

**400 mA:** Switch 1 = On, Switch 2 = Off



**450 mA:** Switch 1 = Off, Switch 2 = On

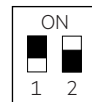

**500 mA:** Switch 1 = On, Switch 2 = On

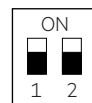

## 4. Electrical values

### 4.1 Efficiency vs load

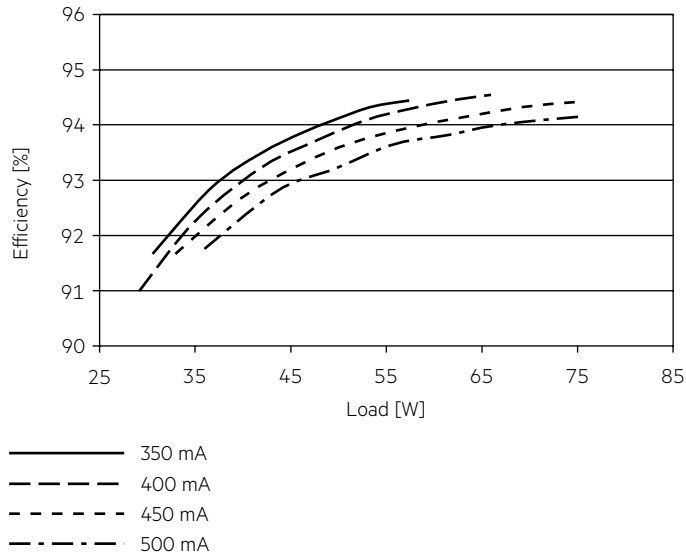

### 4.2 Power factor vs load

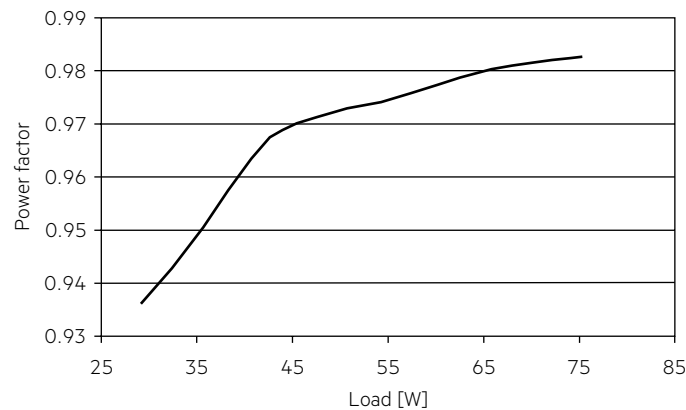

### 4.3 THD vs load

THD without harmonic < 5 mA (0.6 %) of the input current:

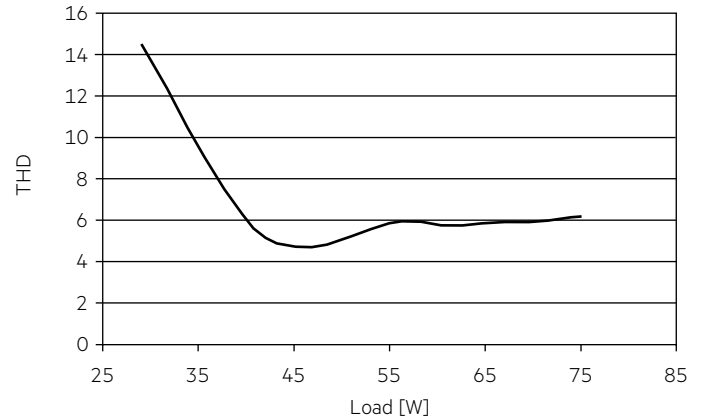

### 4.4 Maximum loading of automatic circuit breakers in relation to inrush current

Automatic circuit breaker type	C10	C13	C16	C20	B10	B13	B16	B20	Inrush current
Installation Ø	1.5 mm <sup>2</sup>	1.5 mm <sup>2</sup>	1.5 mm <sup>2</sup>	2.5 mm <sup>2</sup>	1.5 mm <sup>2</sup>	1.5 mm <sup>2</sup>	1.5 mm <sup>2</sup>	2.5 mm <sup>2</sup>	I <sub>max</sub> Time
<b>LC 75/350-500/167 flexC Ip SNC4</b>	20	27	32	40	12	16	19	24	35 A 220 µs

These are max. values calculated out of inrush current! Please consider not to exceed the maximum rated continuous current of the circuit breaker.

Calculation uses typical values from ABB series S200 as a reference.

Actual values may differ due to used circuit breaker types and installation environment.

### 4.5 Harmonic distortion in the mains supply (at 230 V / 50 Hz and full load) in %

	THD	3.	5.	7.	9.	11.
<b>LC 75/350-500/167 flexC Ip SNC4</b>	< 10	< 8	< 5	< 5	< 5	< 3

Acc. to 61000-3-2. Harmonics < 5 mA or < 0.6 % (whatever is greater) of the input current are not considered for calculation of THD.

## 5. Functions

### 5.1 Short-circuit behaviour

In case of a short circuit on the output side (LED) the LED driver switches off. After elimination of the short-circuit fault the LED driver will recover automatically.

### 5.2 No-load operation

The LED driver works in burst working mode to provide a constant output voltage regulation which allows the application to be able to work safely when LED string opens due to a failure.

### 5.3 Overload protection

If the maximum load is exceeded by a defined internal limit, the LED driver will protect itself and LED may flicker. After elimination of the overload, the nominal operation is restored automatically.

### 5.4 Overtemperature protection

The LED Driver is protected against temporary thermal overheating. If the temperature limit is exceeded the LED Driver will switch off. It restarts automatically.  
The temperature protection is activated typically at 12 °C above  $t_{c \text{ max}}$ .

### 5.5 DC emergency operation

The LED driver is designed to operate on DC voltage and pulsed DC voltage. For a reliable operation, make sure that also in DC emergency operation the LED driver is run within the specified conditions.

Light output level in DC operation ( $EO_{F_{\lambda}}$ ): 98 % (cannot be adjusted)

The voltage-dependent input current of Driver incl. LED module is depending on the used load.

The voltage-dependent no-load current of Driver (without or defect LED module) is for:

AC: < 30 mA

DC: < 15 mA

## 6. Miscellaneous

### 6.1 Insulation and electric strength testing of luminaires

Electronic devices can be damaged by high voltage. This has to be considered during the routine testing of the luminaires in production.

According to IEC 60598-1 Annex Q (informative only!) or ENEC 303-Annex A, each luminaire should be submitted to an insulation test with 500 V<sub>DC</sub> for 1 second. This test voltage should be connected between the interconnected phase and neutral terminals and the earth terminal.  
The insulation resistance must be at least 2 MΩ.

As an alternative, IEC 60598-1 Annex Q describes a test of the electrical strength with 1500 V<sub>AC</sub> (or 1.414 x 1500 V<sub>DC</sub>). To avoid damage to the electronic devices this test must not be conducted.

### 6.2 Conditions of use and storage

Humidity: 5 % up to max. 85 %,  
not condensed  
(max. 56 days/year at 85 %)

Storage temperature: -40 °C up to max. +80 °C

The devices have to be within the specified temperature range ( $t_a$ ) before they can be operated.

The LED driver is declared as inbuilt LED controlgear, meaning it is intended to be used within a luminaire enclosure.

If the product is used outside a luminaire, the installation must provide suitable protection for people and environment (e.g. in illuminated ceilings).

### 6.3 Maximum number of switching cycles

All LED driver are tested with 50,000 switching cycles.

### 6.4 Additional information

Additional technical information at [www.tridonic.com](http://www.tridonic.com) → Technical Data

Lifetime declarations are informative and represent no warranty claim.  
No warranty if device was opened.