

## DALI-2 ROT Touch

Rotary Switch  
with 3 or 5 capacitive touch keys

### Datasheet

Multi Control Device

Rotary knob for controlling  
light level, colour and  
colour temperature

with 3 or 5 additional sensor keys  
for switching between functionalities

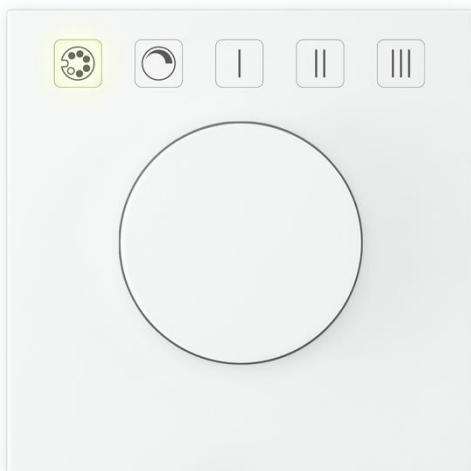



Art. Nr. 86459338-3T

Art. Nr. 86459338-5T



# DALI-2 ROT Touch Control Device

## Overview

- DALI control module for dimming, colour and colour temperature control.
- 3 or 5 capacitive sensor keys to switch between different operating modes or effective ranges
- Several flexible standard layouts - for different applications
- Customized layouts on request
- Individual DALI Commands and operating modes can be assigned to the push and rotary button.
- Multiple Operating modes for dimming and switching
- Operating mode for brightness control  

- Operating mode for control of brightness and colour temperature of DT8 tuneable white luminaires  

- Operating mode for control of light level and colour of DT8 RGB and RGBW luminaires  

- operating mode for control of Lunatone LED-Dimmer in the operating modes Balance&Dim and Colour&Dim.
- Instance mode for sending DALI-2 event messages (D2I) –integration in central control systems
- Multi-master capable, multiple modules can be installed on one DALI-line.
- factory settings allow easy application
- easy configuration via DALI USB interface and DALI-Cockpit software tool
- NFC for simple, wireless configuration with the LUNATONE NFC smartphone app
- the module is supplied directly by the DALI-line, no additional supply required
- double DALI terminals for easy looping of the bus connection
- beeper for localisation
- Versions with integrated bus power supply 70mA, article number addition -PS
- DALI-2 control device according to standard IEC 62386-103.



## Versions – Amount of Sensor Keys

Type	DALI-2 ROT Touch 3	DALI-2 ROT Touch 5
article number	86459338-3T	86459338-5T
amount of capacitive sensor keys	3	5
colour	white (RAL 9016)	white (RAL 9016)

## Version – DALI-2 functionality factory default

Typ	DALI-2 ROT Touch	DALI-2 ROT Touch Integration
article number	86459338- <b>_T-APP</b>	86459338- <b>_T-INT</b>
factory default	Application Controller enabled instances disabled	Application Controller disabled Instances enabled

## Specification, Characteristics

type	DALI-2 ROT Touch
article number	86459338-3T (version with 3 sensor keys) 86459338-5T (version with 5 sensor keys)
NFC	yes

### DALI-Interface, supply

input type	DALI, supply
Marking	DA, DA
input voltage range	9,5V ... 22,5Vdc according to IEC62386
typ. current consumption DALI (at 16,5V)	4,5 mA
current consumption DALI (at 22,5V)	5,6 mA
addresses for control gear	0
addresses for control devices	1

### environmental conditions

storing and transportation temperature	-20°C ... +75°C
operational ambient temperature	-20°C ... +60°C
rel. humidity, none condensing	15% ... 90%

### general data

dimensions	70mm x 70mm x 38mm
shaft diameter	4mm, adapter with 6mm
mounting / intended use	back box
protection class	II in intended use
protection degree	IP20
manual control	rotary knob with integrated pushbutton function
max. start up time	150ms

<b>terminals</b>	
connection type	spring terminal connector
wire size solid core	0,5 ... 1,5 mm <sup>2</sup> (AWG20 ... AWG16)
wire size fine core	0,5 ... 1,5 mm <sup>2</sup> (AWG20 ...AWG16)
wire size using wire end ferrule	0,25 ... 1 mm <sup>2</sup>
stripping length	8,5 ... 9,5 mm / 0,33 ... 0,37 inch
<b>standards</b>	
DALI	IEC62386-101:2014 IEC62386-103:2014
EMV	EN 61547 EN 50015 / IEC CISPR15
safety	EN 61347-2-11 EN 61347-1
markings	DALI-2, CE

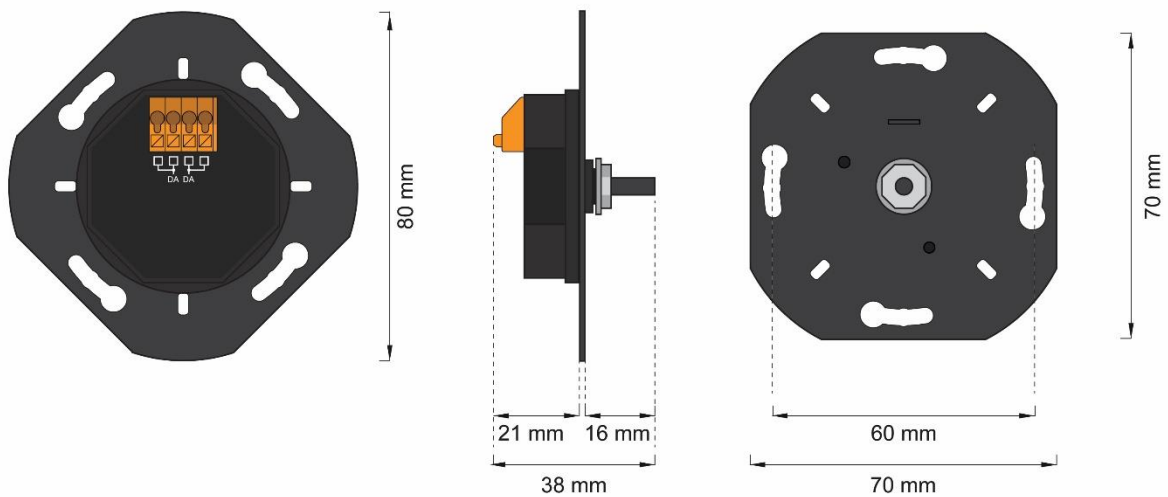

dimensions DALI-2 Rotary Touch

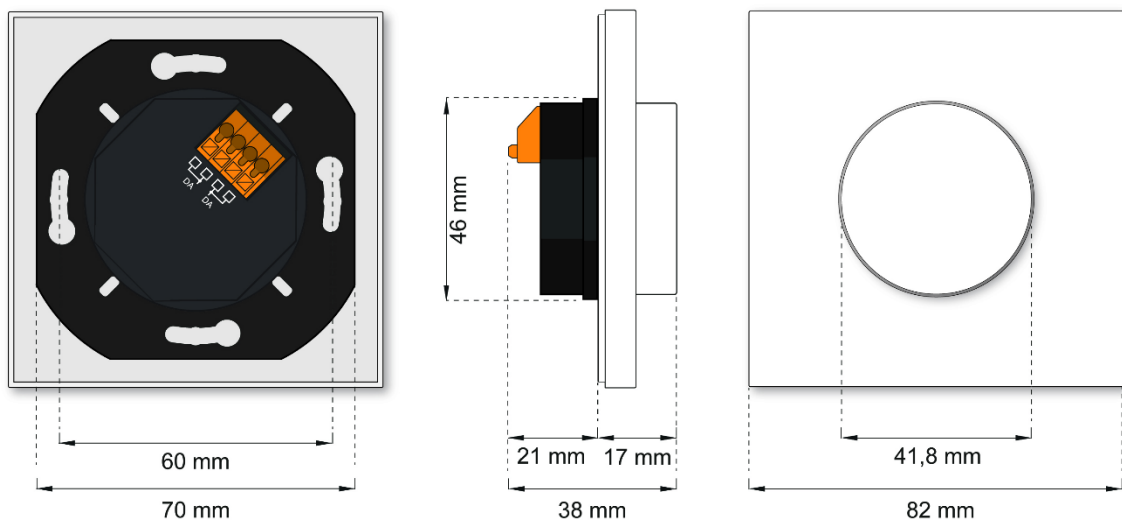

dimensions DALI-2 Rotary Touch with cover

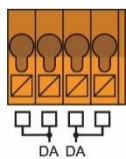

connection plan DALI-2 ROT Touch

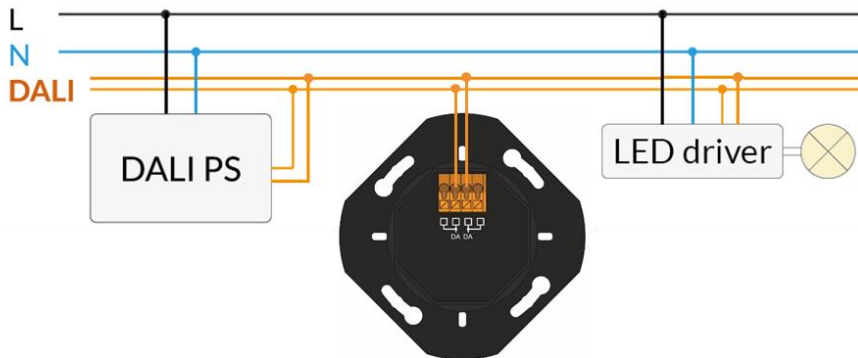

example installation DALI-2 ROT Touch

## Specification, Characteristics – DALI-2 ROT Touch PS: version with integrated Bus Power Supply

Version with integrated bus power supply (70mA). If not stated otherwise in the table below all information for standard version applies – all ROT versions are available with integrated power supply 70mA.

<b>type</b>	<b>DALI-2 ROT Touch-PS</b>
article number	86459338-__T__-PS
<b>input L,N</b>	
input type	supply, mains-voltage
markings	N, L
input voltage range	230V AC
max. input supply current	17 mA
Input supply frequency	50Hz / 60Hz
power consumption max.	2W
start-up time	<250ms
<b>output DA+, DA-</b>	
output type	DALI
markings	DA-, DA+
output voltage range	12Vdc.... 20,5 Vdc
guaranteed DALI supply current	70mA
max. DALI supply current	80mA
Open circuit proof	yes
Short circuit proof	yes
<b>insulation data</b>	
Impulse voltage category	II
Pollution degree	2
Rated insulation voltage	250V
Rated impulse withstanding voltage	4 kV
Insulation DALI / mains	reinforced isolation

Insulation test voltage DALI /mains	3000V a.c.
-------------------------------------	------------

**general data:**

dimensions	70mm x 70mm x 44mm
------------	--------------------

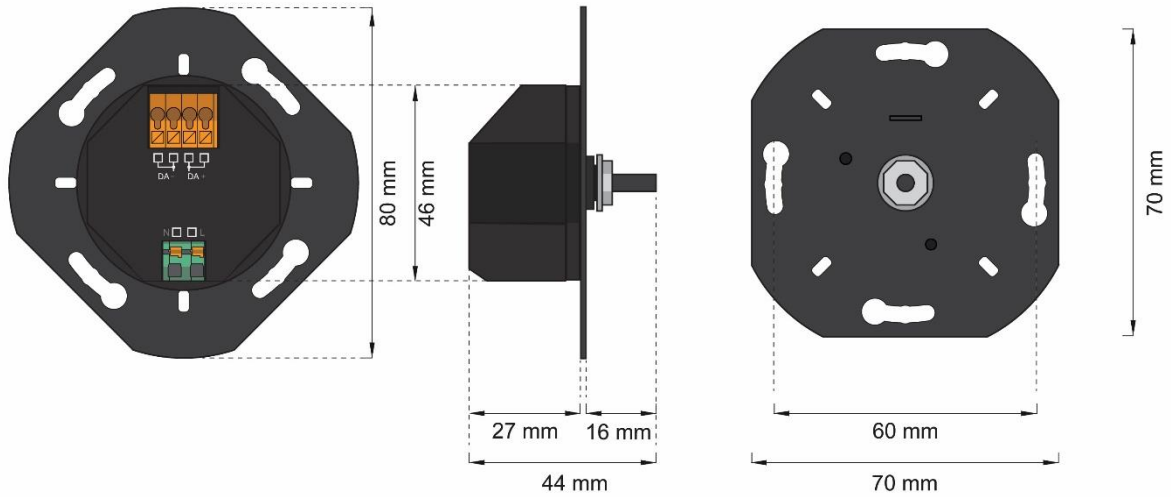

dimensions DALI-2 ROT Touch PS

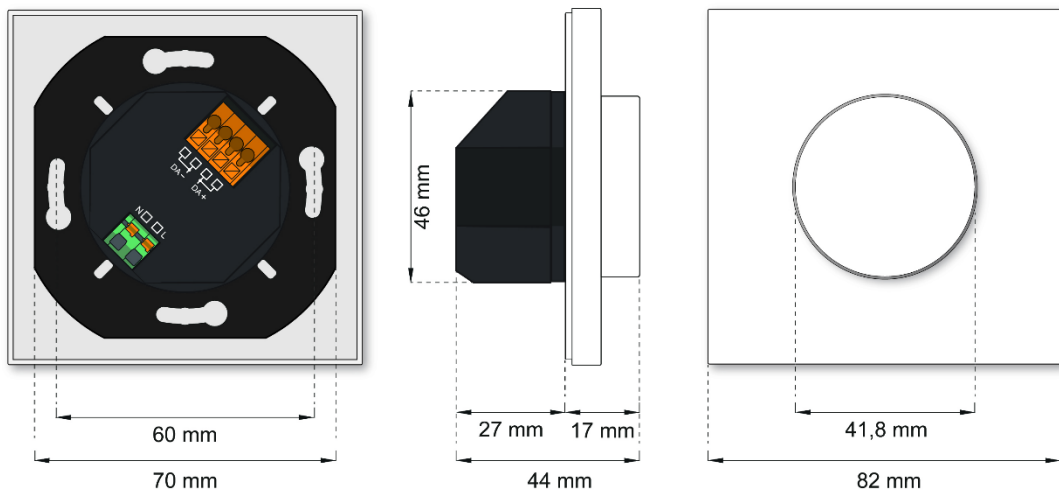

dimensions DALI-2 ROT Touch PS with cover

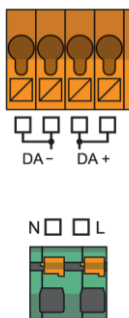

connection plan DALI-2 ROT Touch PS

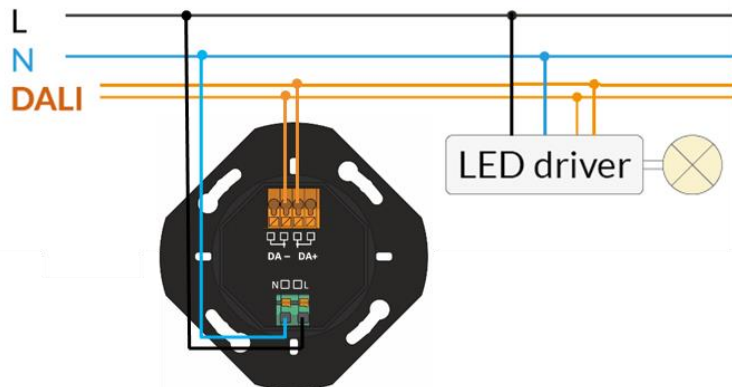

example installation DALI-2 ROT Touch PS

## Installation

- The DALI-2 ROT Touch is intended for mounting on a flush mounted box or on a cavity wall. The shaft diameter is 4 mm (or 6mm with adapter)
- Subsequent simple assembly of the cover with capacitive buttons.
- The DALI-2 ROT Touch module is connected and supplied directly by the DALI-line. If no DALI-2 ROT Touch PS is used a general DALI bus power supply (e.g., DALI PS) is required.
- **DALI-2 ROT Touch PS:** If 2 or more bus power supplies are on the same DALI bus, they need to be connected with the same polarity! (connectors marked with DA+, DA-), see Figure 1 below.
- Installation may only be carried out in a voltage-free state of the system and by qualified specialists.
- National regulations for setting up electrical systems must be followed.
- The DALI wiring can be realised with standard low-voltage installation material. No special cables are required.
- Only 1 wire may be connected to each terminal. When using double wire end ferrules, the connection capacity of the terminal must be considered.
- Multiple DALI-2 ROT Touch and DALI luminaires can be connected to a DALI-line.

 It is possible to connect multiple PS to one DALI line, but **the sum of all maximum supply currents must not exceed 250 mA!**

- **DALI-2 ROT Touch** (and ROT Touch PS with no additional DALI PS): the connection to the DALI terminals can be made regardless of polarity. The bus input is protected against overvoltage (mains voltage).
- The wiring should be carried out as a permanent installation in a dry and clean environment.

 **Attention:** The DALI-signal is not classified as SELV circuit (Safety Extra Low Voltage). Therefore, the installation regulations for low voltage apply.

 **Note:** The cross section: the voltage drop on the DALI line must not exceed 2V at maximum length (300m) and maximum bus load (250mA)

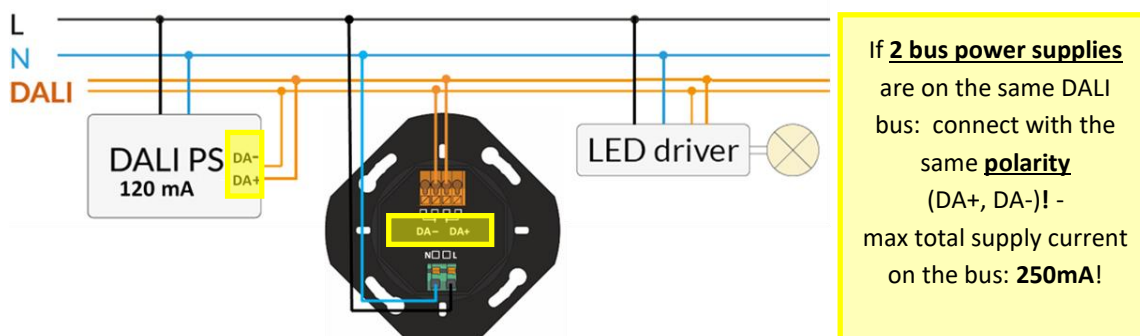
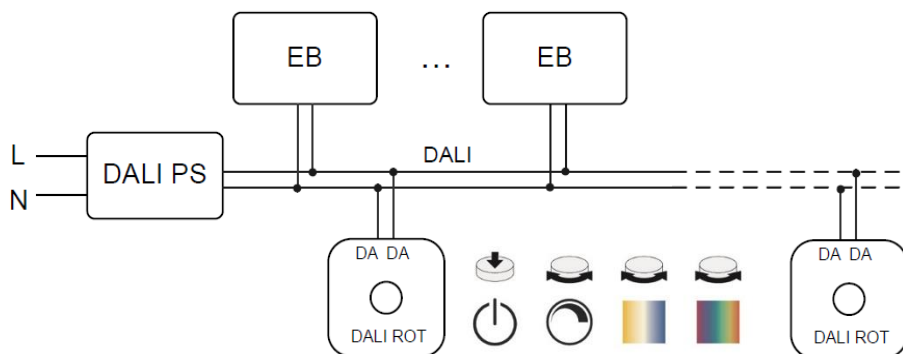

Figure 1. Installation Example DALI-2 ROT Touch PS with additional DALI PS on the DALI Bus

## Typical Application



### Set Up

After installation, the device can be operated with the factory default settings. Factory default settings see page 14.

For simple installations, the basic setting is usually sufficient.

Set up, addressing, changes to the settings such as setting the effective range and functions or configuration of the instances, are possible with the Software tool DALI Cockpit (Windows PC) as well as with the "DALI-NFC" mobile phone app. (Seite 18)

When using the [DALI Cockpit Software](#), the PC must be connected to the DALI bus via a suitable interface module ([DALI-2 USB](#); [DALI USB](#), [DALI-2 WLAN](#), [DALI-2 Display](#), [DALI-2 IoT](#), [DALI 4Net](#), [DALI SCI RS232](#)).

The DALI-2 ROT Touch is automatically recognized by the DALI Cockpit during the addressing process and listed in the device overview.

The addressing is done according to the DALI-2 specification and the device receives a corresponding address.

The device has a buzzer for localization.

Alternatively, the device can also be identified by the serial number on the housing. (The serial number is displayed in the DALI Cockpit in the section "device info" at the top, see also Figure 2, page 9)

### Application and Function

The DALI-2 ROT Touch is a rotary switch and is used to adjust brightness, colour temperature or colour on DALI-compatible luminaries. The function is determined by the selection of the operating mode. Additional capacitive sensor keys enable switching between operating modes, effective ranges and / or DALI commands

**It is necessary to distinguish between application controller and DALI-2 instances.**

**The application controller** gives direct DALI control commands that are immediately executed by the DALI drivers.

**The DALI-2 instances** generate event messages that are interpreted and processed by higher-level control units with DALI connection (e.g. WAGO, Beckhoff, ...).

### DALI-Cockpit

Addressing and device configurations can be done with the [DALI Cockpit Software](#) and a suitable interface module ([DALI-2 USB](#); [DALI USB](#), [DALI-2 WLAN](#), [DALI-2 Display](#), [DALI-2 IoT](#), [DALI 4Net](#), [DALI SCI RS232](#)).

The DALI Cockpit supports:

- addressing (random addressing for DALI-2 control devices, no gear address used)
- device configuration

With the selection of the device in the component tree, the DALI-2 ROT Touch settings page is shown. The settings page is split in three tabs: one for general settings (see Figure 2 below), one for application settings (see Figure 3 on page 16) and one tab for instance settings (Figure 4, page 18).

### General Settings

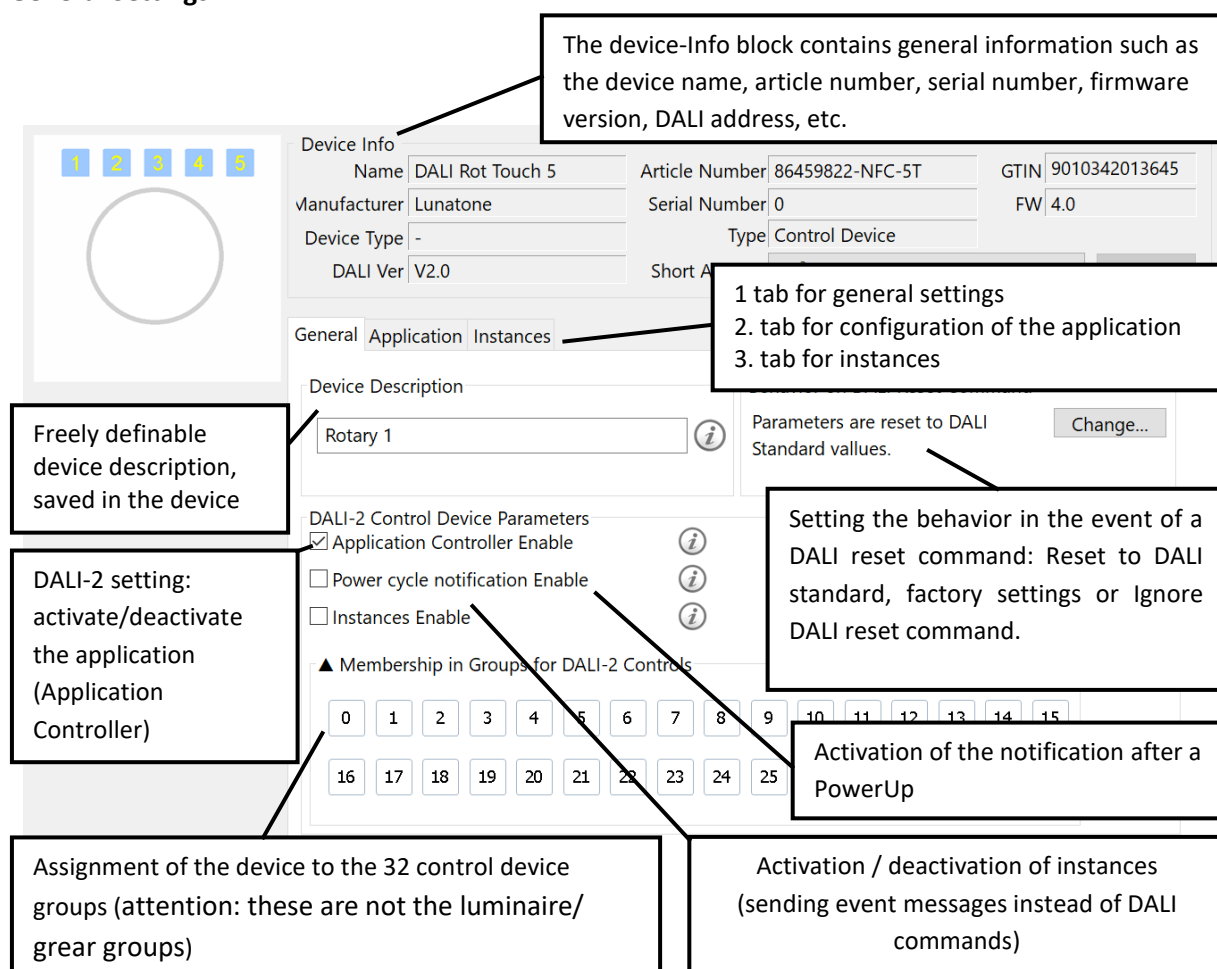

Figure 2. DALI Cockpit: general Configuration options – Tab: “General”

**Configuration of the application**

Application Controller enabled

The currently selected sensor key is illuminated. For each of the 3 or 5 sensor keys

1. a DALI command
2. the functionality (operating mode and toggle functions)
3. and the effective range can be defined

When the sensor key is pressed, the specified DALI command is sent. The defined effective range and the function of the rotary remain active until another sensor key is pressed.

Following **DALI commands** can be set to be sent on selection of a sensor key:

Command	Description
None	send no command
DIRECT ARC POWER	specify the light level in %
RECALL MAX	Recalls light level MAX
RECALL MIN	Recalls light level MIN
GOTO LAST ACTIVE LEVEL	command for DALI2 gears – recalls last active light level
GO TO SCENE __	Recalls respective scene (0-15)

**Destination address / effective range**

defines which devices are affected by the commands sent. Possible destination addresses:

- Broadcast (to all)
- DALI group (0 - 15)
- DALI single address (0 - 63)

Up to 4 different target addresses can be defined for each button input. When the button is pressed the target addresses 1 to 4 will be processed sequentially.

In operating modes 1-4 (Intensity, Tunable White, RGB and RGBW) commands are sent to all destination addresses. However, it is

recommended to use only one address entries for colour control.

**Rotary: Functionality when turning or pressing (Toggle).** The following operating modes can be set for the turning function:

Operating Mode	Description
Brightness (UP-DOWN)	Dimming via UP and DOWN commands
Brightness (DAP: 1%-100%)	Dimming via DAP commands
Colour RGB	Changing colours RGB
Colour White Channel	Change of White channel
Colour&Dim or Balance&Dim	For controlling Lunatone dimmers in the Colour & Dim or Balance & Dim operating mode
Tunable White	Changing colour temperature
Blinds	Control of blinds

When the rotary knob is pressed, a switch-on and a switch-off command is sent depending on the light status (toggle). The following switch-on and switch-off commands are available:

On Commands:

Command	Description
DIRECT ARC POWER	specify the light level in %
RECALL MAX	Recalls light level MAX
RECALL MIN	Recalls light level MIN
GOTO LAST ACTIVE LEVEL	command for DALI2 gears – recalls last active light level
GO TO SCENE __	Recalls respective scene (0-15)

Off Commands:

Command	Description
DIRECT ARC POWER 0	specify the light level 0 %
OFF	turn light off
GO TO SCENE X	Recalls respective scene (0-15)

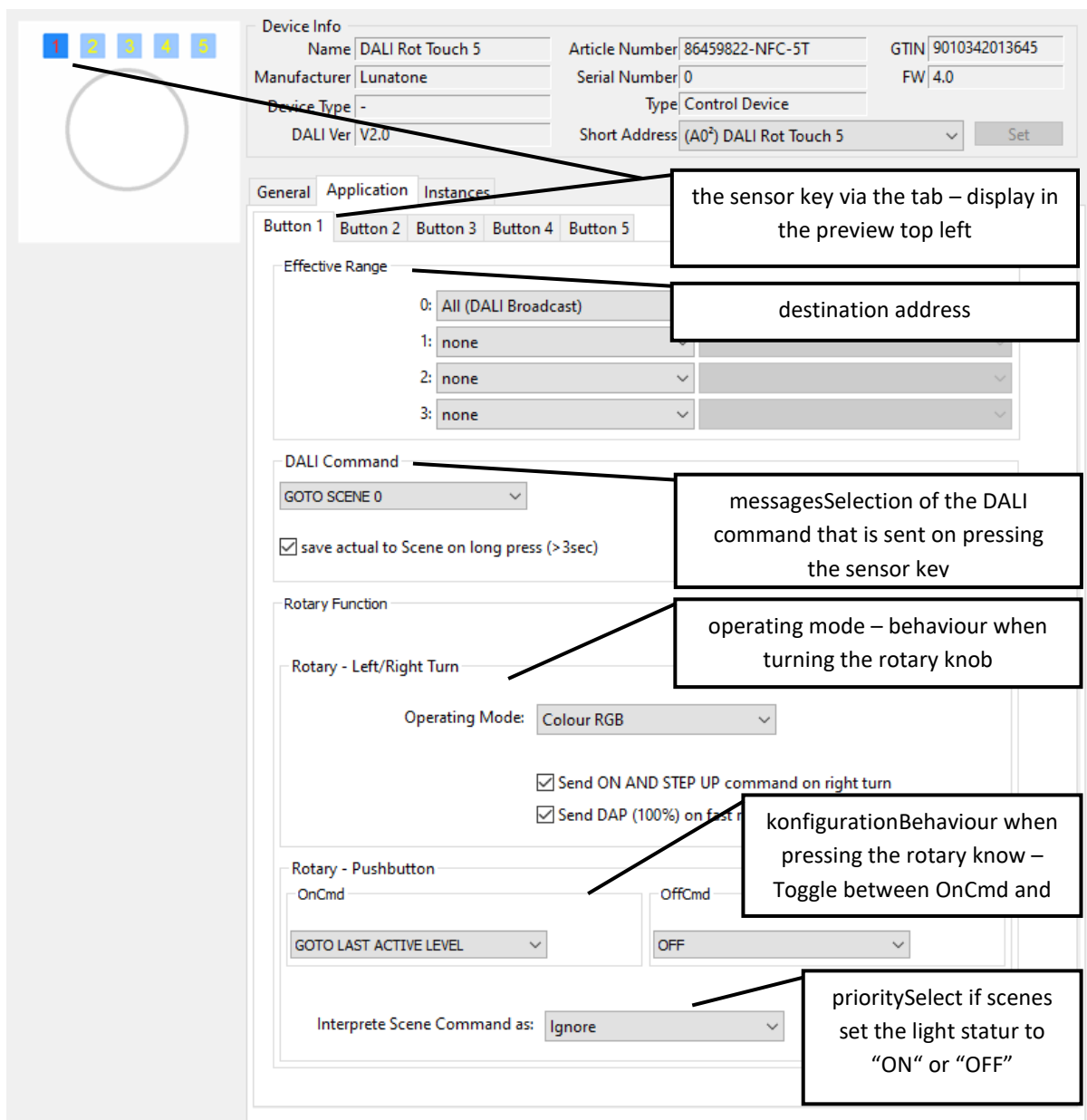
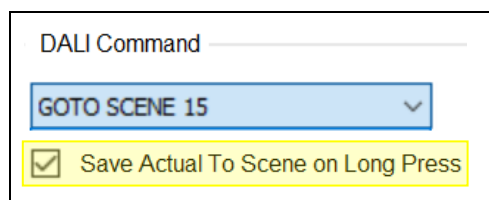

Figure 3. DALI Cockpit: configuration of the application – Tab: “Application”

**Additional Functions**

**Default:** When selecting the checkbox: "Default" for buttons 2 - 5, the settings of button 1 for the respective function (DALI command, effective range, rotary mode) are adopted.

**Save scenes:** when selecting a scene as sensor key command - it can additionally be set that on holding the sensor key for a over 3seconds, the current state of the effective range is saved for the scene.



**ON on a Right Turn:**

- Right Turn Action if State OFF
- Send ON AND STEP UP command on right turn
  - Send DAP(254) on fast right turn

It can be set that a right turn not only dims up when the light is on but also turns on the light if it is currently off. (Send ON and Step Up). Additionally, it can be set that a fast right turn will set the brightness to 100% (maximum light level).

found under

<https://www.lunatone.com/en/product/dali-2-rot-touch/>

**Factory Default settings**

The DALI-2 ROT Touch 3 and DALI-2 ROT Touch 5 are delivered with different standard layouts and presets.



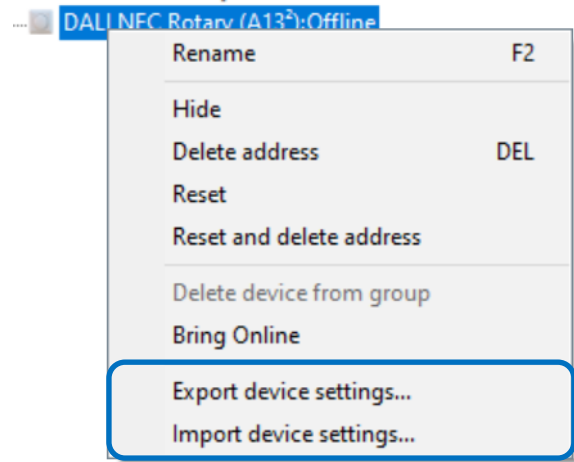

The various delivery states / default settings can also be downloaded and saved or loaded by right-clicking on the device in the device overview. Select the option "Export device settings ..." or "Import device settings ..." to save or load the configuration respectively.







All configuration files and layout descriptions of the Lunatone Standard layouts can be

**STANDARD LAYOUT - ROT Touch 5**





3 Scenes , 2 Groups

					
	Key 1	Key 2	Key 3	Key 4	Key 5
DALI Command	<b>Scene 1</b>	<b>Scene 2</b>	<b>Scene 3</b>	-	-
Effective Range	Broadcast	Broadcast	Broadcast	<b>Group 0</b>	<b>Group 1</b>
Rotary - Mode	Brightness	Brightness	Brightness	Brightness	Brightness
Rotary - On Cmd	max	max	max	max	max
Rotary - Off Cmd	off	off	off	off	off





2 Scenes , 2 Groups, Blinds

					
	Key 1	Key 2	Key 3	Key 4	Key 5
DALI Command	<b>Scene 1</b>	<b>Scene 2</b>	-	-	-
Effective Range	Broadcast	Broadcast	<b>Group 0</b>	<b>Group 1</b>	<b>Group 15</b>
Rotary - Mode	Brightness	Brightness	Brightness	Brightness	<b>blinds up / down</b>
Rotary - On Cmd	max	max	max	max	stop
Rotary - Off Cmd	off	off	off	off	stop

Tunable White , 3 Scenes



					
	Key 1	Key 2	Key 3	Key 4	Key 5
DALI Command	-	-	<b>Scene 1</b>	<b>Scene 2</b>	<b>Scene 3</b>
Effective Range	Broadcast	Broadcast	Broadcast	Broadcast	Broadcast
Rotary - Mode	<b>Tunable White</b>	<b>Brightness</b>	Brightness	Brightness	Brightness
Rotary - On Cmd	max	max	max	max	max
Rotary - Off Cmd	off	off	off	off	off

RGB , 3 Scenes



					
	Key 1	Key 2	Key 3	Key 4	Key 5
DALI Command	-	-	<b>Scene 1</b>	<b>Scene 2</b>	<b>Scene 3</b>
Effective Range	Broadcast	Broadcast	Broadcast	Broadcast	Broadcast
Rotary - Mode	<b>RGB</b>	<b>Brightness</b>	Brightness	Brightness	Brightness
Rotary - On Cmd	max	max	max	max	max
Rotary - Off Cmd	off	off	off	off	off

## STANDARD LAYOUT – ROT Touch 3



### 2 Scenes, 1 Group

			
	Key 1	Key 2	Key 3
DALI Command	<b>Scene 1</b>	<b>Scene 2</b>	-
Effective Range	Broadcast	Broadcast	<b>Group 0</b>
Rotary - Mode	Brightness	Brightness	Brightness
Rotary - On Cmd	max	max	max
Rotary - Off Cmd	off	off	off



### 1 Scene, 1 Group, Blinds

			
	Key 1	Key 2	Key 3
DALI Command	<b>Scene 1</b>	-	-
Effective Range	Broadcast	<b>Group 0</b>	<b>Group 15</b>
Rotary - Mode	Brightness	Brightness	<b>blinds up / down</b>
Rotary - On Cmd	max	max	stop
Rotary - Off Cmd	off	off	stop

### Tunable White, 1 Scene

			
	Key 1	Key 2	Key 3
DALI Command	-	-	<b>Scene 1</b>
Effective Range	Broadcast	Broadcast	Broadcast
Rotary - Mode	<b>Tunable White</b>	<b>Brightness</b>	Brightness
Rotary - On Cmd	max	max	max
Rotary - Off Cmd	off	off	off

Colour, 1 Scene

			
	Key 1	Key 2	Key 3
DALI Command	-	-	<b>Scene 1</b>
Effective Range	Broadcast	Broadcast	Broadcast
Rotary - Mode	<b>RGB</b>	<b>Brightness</b>	Brightness
Rotary - On Cmd	max	max	max
Rotary - Off Cmd	off	off	off

DALI-2 Instances

In this operating mode no DALI control commands are sent on the bus, but DALI-2 event messages for DALI-2 compatible central control systems.

To make the DALI-2 instances available, they must be activated via "enable Instance". (The version DALI-2 ROT-T-INT is already in instance mode as factory default)

The DALI-2 ROT with 3 or 5 sensor keys supports 6 or 8 instances respectively. 4 or 6 of instance type 1 - input device pushbutton IEC62386-301.

1 instance of instance type 0 Generic / General Purpose (IEC62386-103) for evaluating the rotary movement.

And 1 instance of instance type 2, (Absolute input device IEC62386-302), with 8 bit resolution, as an alternative evaluation of the rotary movement.

The following assignment applies:

Instance 0	Type 1	Rotary pushbutton
Instance 1	Type 0	Rotary rotation
Instance 2	Type 2	Rotary rotation
Instance 3	Type 1	Sensor key 1
Instance 4	Type 1	Sensor key 2
Instance 5	Type 1	Sensor key 3

And additionally for the 5 sensor key version:

Instance 6	Type 1	Sensor key 4
Instance 7	Type 1	Sensor key 5

As defined in the standard, the following events are supported and placed on the DALI bus as INPUT NOTIFICATIONS.

**Instance Type 1 – Pushbutton:**

Event name	Event Information	Description
Button released	00 0000 0000b	The button is released
Button pressed	00 0000 0001b	The button is pressed
Short press	00 0000 0010b	The button is pressed and released, without being pressed quickly again (in case of double press enabled), or the button is pressed and quickly released (in case double press is disabled)
Double press	00 0000 0101b	The button is pressed and released, quickly followed by another button press
Long press	00 0000	The button is pressed

start	1001b	without releasing it
Long press repeat	00 0000 1011b	Following a long press start condition the button is still pressed, the event occurs at regular intervals as long as the condition holds
Long press stop	00 0000 1100b	Following a long press start condition, the button is released
Button free	00 0000 1110b	The button has been stuck and is now released
Button stuck	00 0000 1111b	The button has been pressed for a very long time and is assumed stuck.

Tab.4

Instanz Type 0 - General Purpose:

Event name	Event Information	Description
Rotation Clockwise Started	00 0000 0000b	The rotary knob has started to rotate clockwise
Rotation Counter Clockwise Started	00 0000 0001b	The rotary knob has started to rotate counter clockwise
Rotation Stopped	00 0000 0010b	The rotation of the rotary knob has stopped

Tab 5.

Further parameters of instances 0-7 are: event filter, event timer settings (short timer, double timer, repeat timer, stuck timer), which can be configured via the DALI Cockpit software, see Figure 4, below.

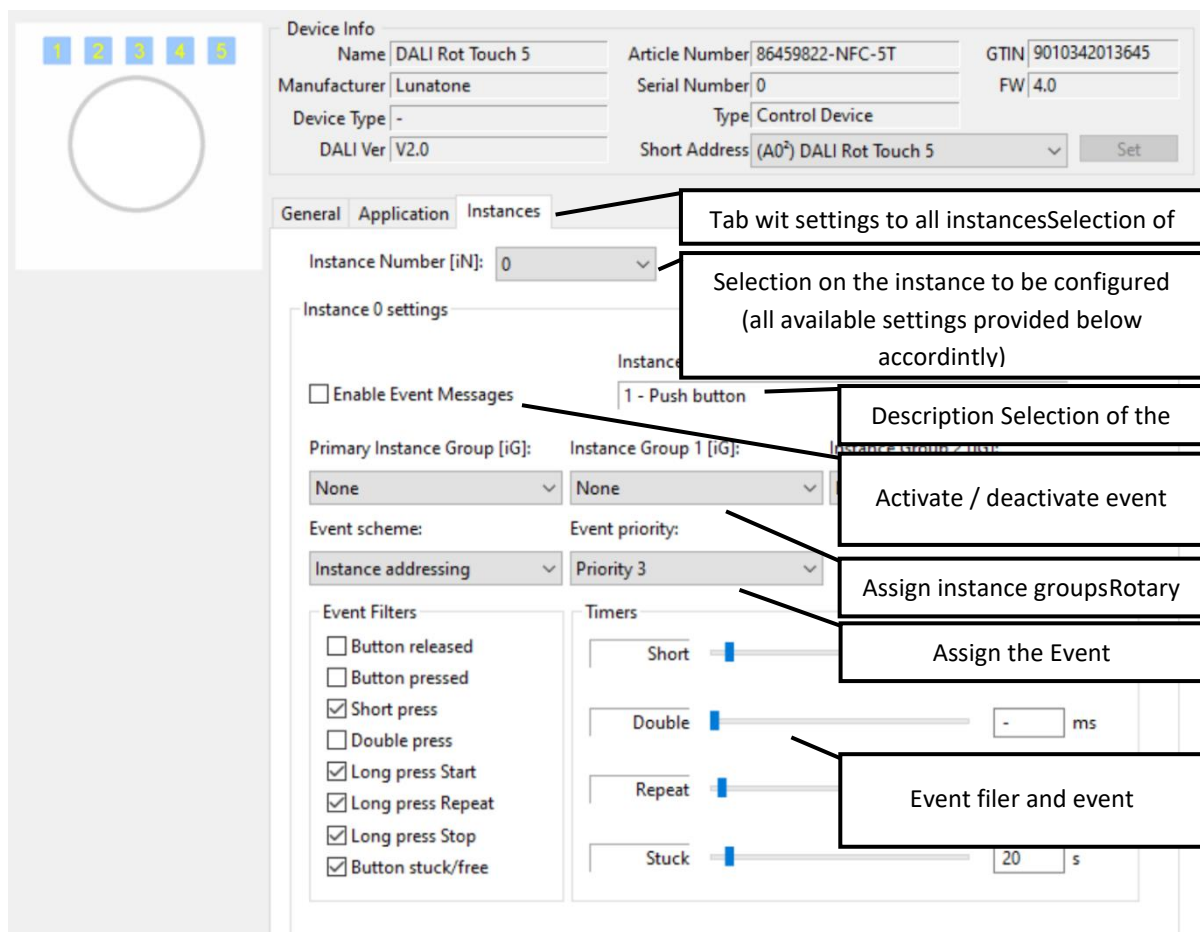

Figure. 4 Configuration of Instances (Tab "Instances")

NFC-Functionality



The DALI-2 ROT Touch includes a nearfield communication interface. This allows easy configuration over the NFC interface with a smartphone app, during installation.

- The DALI-2 ROT Touch does not have to be connected to a DALI power supply for configuration with NFC, it is supplied directly via NFC.
- The functions required to operate the application controller can be configured with the Lunatone DALI NFC App.
- Easy to use smartphone app for quick configuration in the field as well as preparation before installation.
- Fast transfer and copying of device settings

**App Download:**

The Lunatone "DALI NFC" app is available for Android devices on the Play Store.



**Connect:**

- Switch on the NFC function and start the "DALI NFC" app.
- This is followed by the request to pair an "NFC-enabled device".
- As soon as the DALI-2 ROT Touch is within range (indicated by signal tone / vibration) the device is automatically read out and shown on the display.



 It is important that the NFC antennas of the two devices are as close as possible to each other.

 For the application to work your smartphone needs to support NFC. Information on the NFC interface of your smartphone please check the instructions of the device manufacturer.

## Lunatone DALI NFC App

The settings are the same as in the DALI Cockpit

Available configurations:

- Read out and assign DALI-2 control device address
- Assign to control device groups
- Choose the operating mode
- For operating modes 1-4 and 6: Effective range,
  - ON commands:
    - DAP,
    - RECALL MAX,
    - RECALL MIN,
    - GOTO SCENE X,
    - GOTO LAST ACTIVE LEVEL
  - OFF commands:
    - DAP0,
    - OFF,
    - GOTO SCENE X
- On with Dimming” Feature: Turns light ON with a right turn if the light status is currently OFF

*Settings for instances cannot be made with the DALI NFC mobile app.*

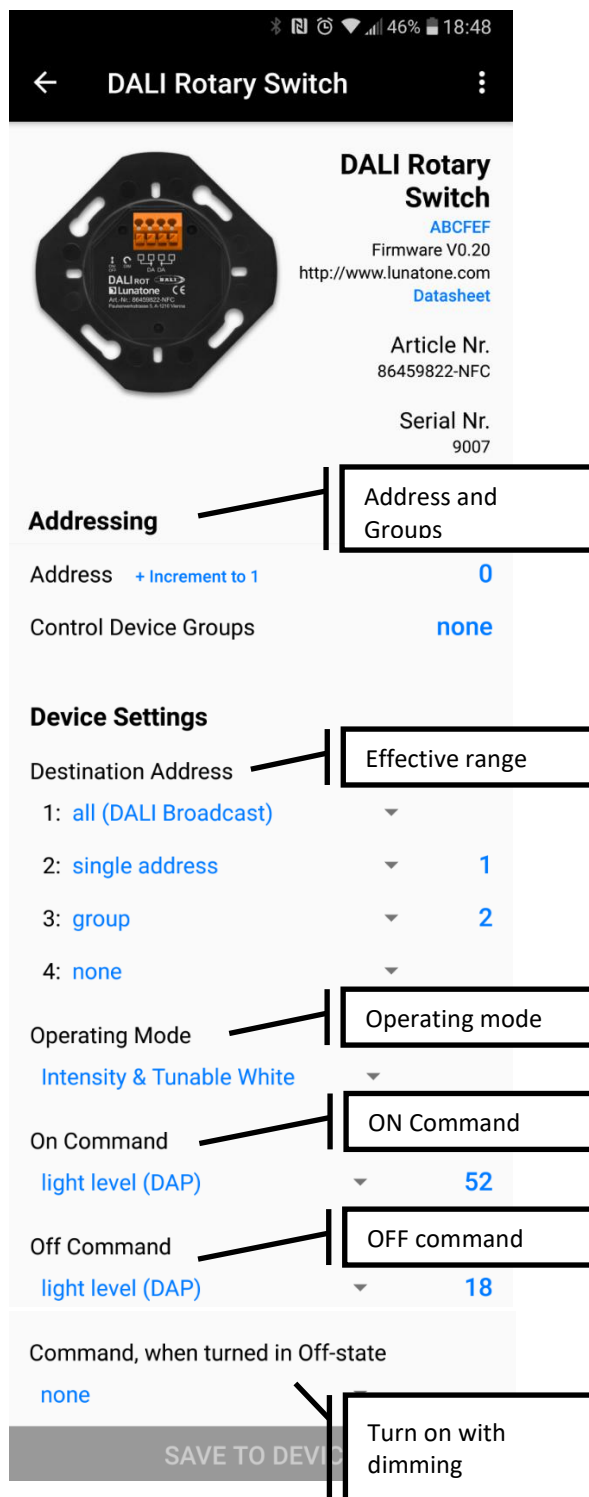

## Purchase Information

### Version 3 Sensor Keys:

Art. Nr. 86459338-3T-APP-\_\_

Factorydefault: Application-Controller enabled

Standard layout article number addition:

2 Scenes, 1 Group: **-L1**

1 Scene, 1 Group, Blinds: **-L2**

Tunable White **-L3**

Colour **-L4**

Art. Nr. 86459338-3T-INT-\_\_

Factorydefault: Instance mode enabled

Standard layout article number addition:

2 Scenes, 1 Group: **-L1**

1 Scene, 1 Group, Blinds: **-L2**

Tunable White **-L3**

Colour **-L4**

Version with integrated PS 70mA

Art. Nr. 86459338-3T-\_\_-PS-\_\_

### Version 5 Sensor Keys:

Art. Nr. 86459338-5T-APP-\_\_

Factorydefault: Application-Controller enabled

Standard layout article number addition:

3 Scenes, 2 Groups: **-L1**

2 Scenes, 2 Groups, Blinds: **-L2**

Tunable White **-L3**

Colour **-L4**

Art. Nr. 86459338-5T-INT-\_\_

Factorydefault: Instance mode enabled

Standard layout article number addition:

3 Scenes, 2 Groups: **-L1**

2 Scenes, 2 Groups, Blinds: **-L2**

Tunable White **-L3**

Colour **-L4**

Version with integrated PS 70mA

Art. Nr. 86459338-5T-\_\_-PS-\_\_

## Additional Information and Equipment

DALI-Cockpit – DALI system configuration tool, free when using a Lunatone interface device

<http://lunatone.at/en/downloads/Lunatone-DALI-Cockpit.zip>

Lunatone DALI products

<http://www.lunatone.at/en/>

Lunatone datasheets and manuals

<http://lunatone.at/en/downloads/>

## Contact

Technical Support: [support@lunatone.com](mailto:support@lunatone.com)

Requests: [sales@lunatone.com](mailto:sales@lunatone.com)

[www.lunatone.com](http://www.lunatone.com)



## Disclaimer

Subject to change. Information provided without guarantee. The datasheet refers to the current delivery.

The compatibility with other devices must be tested in advance to the installation.