

Sure Seal - Teknisk info

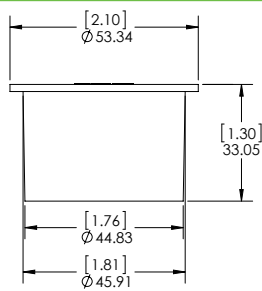

Waterless.dk



HOUSING (NO GASKET)

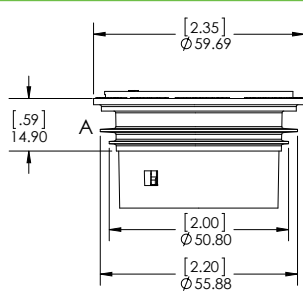

HOUSING & GASKET

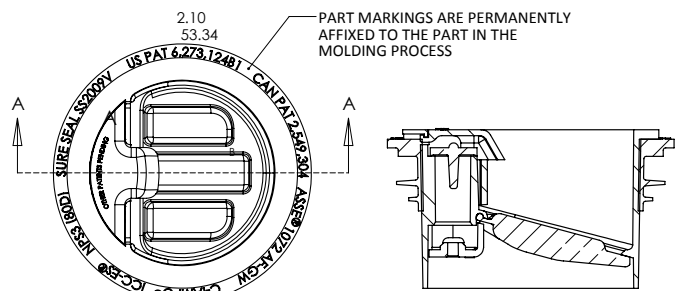

SECTION A-A

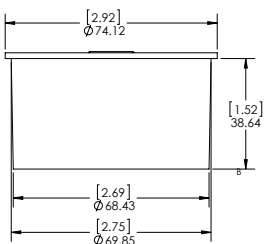

HOUSING (NO GASKET)

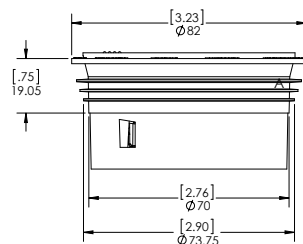

HOUSING & GASKET

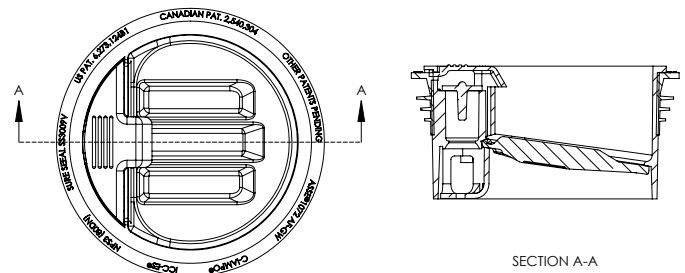

SECTION A-A

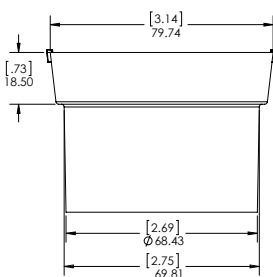

HOUSING (NO GASKET)

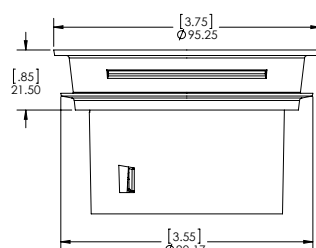

HOUSING & GASKET

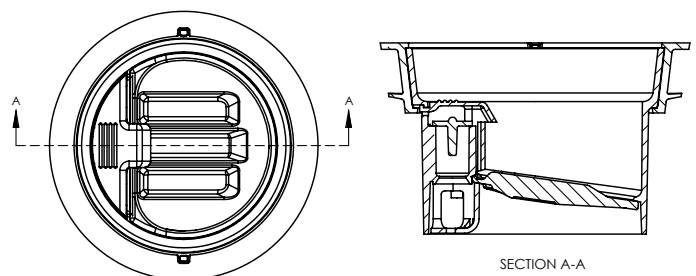

SECTION A-A

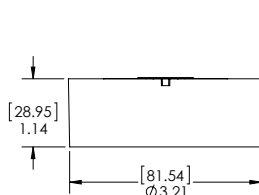

HOUSING (NO GASKET)

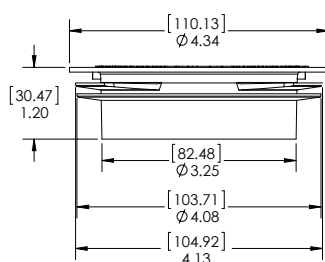

HOUSING & GASKET

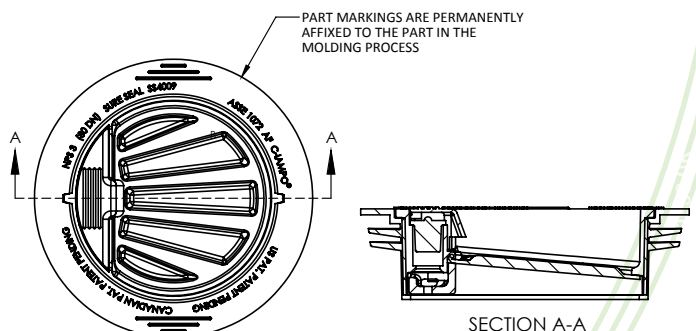

SECTION A-A

PART MARKINGS ARE PERMANENTLY AFFIXED TO THE PART IN THE MOLDING PROCESS