



Installation and Maintenance Guide

Oras Nova



Water Is Worth Loving.

- GB** Thank you for selecting an Oras product. This installation and maintenance guide will introduce you to the installation, functions, and use of the faucet. Please read the guide carefully before installation, and keep it on hand for any potential future maintenance. If an operating malfunction or fault appears in your faucet, a plumbing professional is your best source of assistance. Information on cleaning the faucet, conditions of use, and warranty terms is available in the brochure that came with your product: "Important notes on Oras products".
- CZ** Děkujeme za výběr produktu Oras. Tento návod pro instalaci a údržbu Váš provede montáží, funkcí a použitím vodovodní baterie. Prosíme čtěté návod pozorně ještě před montáží samotné baterie a uschovejte pro případ možné další údržby. V případě výskytu jakýchkoli problémů s Vaší baterií je profesionální instalatér nejlepší možnou volbou pro asistenci při řešení těchto problémů. Informace jak čistit, používat vodovodní baterii a záruční podmínky jsou uvedeny v brožuře „Important notes on Oras products“, která Vám je dodána zároveň s výrobkem Oras.
- DE** Vielen Dank, dass Sie sich für ein Oras Produkt entschieden haben. Dieser Wartungs- und Installationshandbuch gibt Ihnen Informationen über die Installation, Funktion und Handhabung der Armatur. Bitte lesen Sie sich vor der Installation der Armatur diese Anleitung genau durch und verwahren Sie diese für evtl. zukünftige Wartungen auf. Bei einer Fehlfunktion der Armatur ist Ihr Fachhandwerker der beste Ansprechpartner. Informationen zur Reinigung, Handhabung sowie Garantie können Sie dem Prospekt „Important notes on Oras products“ (Wichtige Informationen über Oras Produkte) entnehmen, der Ihrer Armatur beiliegt.
- DK** Tak fordi du valgte et Oras produkt. Denne installations- og vedligeholdelses guide vil guide dig gennem installationen, funktionerne og brugen af armaturet. Læs venligst denne guide igennem inden installationen og gem den til senere brug. Hvis der mod forventning skulle opstå problemer med armaturet, er den bedste løsning at kontakte en autoriseret VVS installatør. Information om rengøring og brug af armaturet samt garantivilkår findes i brochuren der fulgte med dit armatur: "Important notes on Oras products".
- EE** Täname, et valisite Orase toote. Käesolev paigaldus- ja hooldusjuhend tutvustab Teile segisti paigaldamist, tööpõhimõtteid ning kasutamist. Palume Teil enne segisti paigaldamist käesoleva juhendiga hoolikalt tutvuda ning säilitada see võimalike tulevaste hoolduste tarbeks. Häirete korral segisti töös soovitage Teil pöörduda ala asjatundja poole. Info segisti puhastamise, kasutamise ja garantiitingimuste kohta leiate segistiga kaasasolevast brošüürist "Important notes on Oras products".
- ES** Gracias por seleccionar un producto de Oras. Esta guía de instalación y de mantenimiento le dará a conocer la instalación, las funciones y el uso de la grifería. Por favor, lea la guía cuidadosamente antes de la instalación, y téngala a mano para cualquier mantenimiento que tuviera que realizar en un futuro potencial. Si un mal funcionamiento o defecto de funcionamiento apareciera en su grifo, un profesional instalador es su mejor fuente de asistencia. Información sobre la limpieza del grifo, las condiciones de uso y condiciones de la garantía está disponible en el folleto que acompaña al producto: "Notas importantes sobre los productos Oras".
- FI** Kiitos, että valitsitte Oras tuotteen. Tämä asennus- ja huolto-ohje tutustuttaa teidät hanan asennukseen, toimintaan ja käyttöön. Lukekaa ohje huolellisesti ennen asennusta. Säästäkää ohje mahdollisia myöhempiä huoltotoimenpiteitä varten. Mikäli hanassanne ilmenee jokin toimintahäiriö tai vika, LVI-asiantuntija pystyy antamaan parhaan mahdollisen avun. Hanan puhdistuksesta, käyttöolosuhteista ja takuuehdoista voit lukea tuotteen mukana tulleesta "Important notes on Oras products"-vihkosesta.
- FR** Merci d'avoir choisi un produit Oras. Veuillez lire attentivement cette notice, afin de vous familiariser avec l'utilisation et les fonctions de l'appareil. Conservez ce document, afin, le cas échéant, de pouvoir à nouveau le consulter. En cas de problème, votre plombier est votre meilleur atout. Vous trouverez dans la brochure des informations pour le nettoyage du produit, les garanties, sous la rubrique « notice importante sur les produits Oras ».
- IT** Grazie per aver scelto un prodotto Oras. Il manuale di installazione e manutenzione vi introdurrà all'installazione, alle funzioni, ed all'uso del rubinetto. Si prega di leggere attentamente il manuale prima dell'installazione, e tenerlo a portata di mano per qualsiasi intervento di manutenzione futura. Se si manifesta un malfunzionamento di esercizio o difetto sul vostro rubinetto, un idraulico professionista è la migliore fonte di assistenza. Informazioni sulla pulizia del rubinetto, le condizioni d'uso e condizioni di garanzia sono disponibili nella brochure in dotazione con il prodotto: "Note importanti per i prodotti Oras".

- LT** Ačiū, kad pasirinkote "Oras" gaminį. Šis instaliavimo ir eksploataavimo vadovas supažindins jus su maišytuvo instaliavimu, funkcijomis ir naudojimo ypatybėmis. Prašome dėmesingai perskaityti šį vadovą prieš gaminio instaliavimą ir laikyti jį prieinamoje vietoje galimam aptarnavimui atvejui. Jeigu eksploatacijos metu atsirastų gaminio sutrikimų ar defektų geriausias jūsų patarėjas būtų profesionalus santechnikas. Informaciją apie gaminio valymą, naudojimą ir garantinio aptarnavimo sąlygas atrasite prie gaminio pridėtoje brošiūroje „Svarbūs „Oras“ gaminių priežiūros nurodymai“.
- LV** Paldies, ka izvēlējāties Oras produktus. Šis uzstādīšanas un apkopes ceļvedis iepazīstina ar jaucējkrānu uzstādīšanu, darbību un lietojamību. Lūdzu uzmanīgi izlasiet ceļvedi pirms darbu uzsākšanas un saglabājiet to kā izziņas avotu apkopes darbu veikšanai nākotnē. Profesionāls santehtniks būtu labākais atbalsts gadījumos, ja jaucējkrānā rodas funkcionāli traucējumi. Jaucējkrāna tīrīšanas un lietošanas norādījumi, garantijas noteikumi ir pieejami jūsu produktam pievienotā brošūrā „Svarīgi norādījumi par Oras jaucējkrānu apkopi“.
- NL** Dank u wel voor het kiezen van een Oras product. Deze installatie- en onderhoudsgids zal u de weg wijzen voor installatie, functies en gebruik van de kraan. Gelieve de handleiding aandachtig te lezen alvorens installatie, en houdt het bij de hand voor toekomstig onderhoud. Wanneer er een gebruiksprobleem of fout in uw kraan merkbaar wordt, dan is een professionele loodgieter de aangewezen hulp. Informatie over hoe de kraan te poetsen, gebruiksvoorwaarden, en garantievoorwaarden is terug te vinden in de brochure die met uw kraan werd opgestuurd: "belangrijke nota's over Oras producten".
- NO** Tusen takk for at du valgte et produkt fra Oras. Denne installasjons- og monteringsveilederen forteller deg hvordan dette produktet installeres, fungerer og brukes. Vær vennlig å les veilederen før du installerer produktet. Ta vare på veiledningen til evt. senere bruk. Hvis du oppdager feil ved produktet, bør du tilkalle rørlegger. Informasjon om rengjøring av produktet, bruksområder og garanti er tilgjengelig i heftet som lå sammen med produktet: "Viktige bemerkninger om Orasprodukter"
- PL** Dziękujemy za wybór produktów Oras. Przedstawiamy instrukcję instalacji i konserwacji, która zawiera wskazówki odnośnie instalacji, funkcjonalności oraz użytkowania baterii Oras. Prosimy przeczytać uważnie instrukcję przed instalacją i zachować ją dla potrzeb przyszłej konserwacji. W razie awarii podczas użytkowania lub pojawienia się wady baterii najlepszym źródłem pomocy jest profesjonalny serwis Oras. Informacje dotyczące czyszczenia baterii, sposobu użytkowania oraz warunków gwarancji są dostępne w załączonej do baterii broszurce "Important notes on Oras products".
- RO** Vă mulțumim pentru alegerea unui produs Oras. Acest ghid de instalare și întreținere vă prezintă modalitatea de instalare, funcțiile și modul de exploatare a bateriei. Parcurgeți cu atenție acest ghid înainte de instalare și păstrați-l la îndemână pentru efectuarea potențialelor operațiuni ulterioare de întreținere. În situația în care, pe parcursul exploatarii bateriei, apare o disfuncționalitate sau o defecțiune, cea mai bună sursă de asistență o reprezintă un instalator profesionist. Informații referitoare la curățirea bateriei, condițiile de exploatare și termenii de garanție puteți consulta în broșura "Note importante referitoare la produsele Oras", care v-a fost livrată împreună cu produsul pe care l-ați achiziționat.
- RU** Благодарим Вас за выбор продукции Oras. Из этой инструкции Вы узнаете о функциях смесителя и о порядке его установки и эксплуатации. Пожалуйста, внимательно прочитайте эту инструкцию перед установкой смесителя, и держите её под рукой на случай возникновения вопросов или необходимости обслуживания смесителя. В случае нарушения работы смесителя рекомендуем Вам обращаться к квалифицированным специалистам. Информация об уходе за смесителем, рекомендациях по его эксплуатации и условиях гарантии изложена в прилагаемой брошюре «Important notes on Oras products».
- SE** Tack för att du valt en produkt från Oras. Den här installations- och skötselanvisningen kommer att guida dig igenom blandarens installation, funktion och användande. Läs igenom anvisningen noggrant innan installation av blandaren och spara den för eventuella framtida servicebehov. Om ett funktionsfel uppstår bör du vända dig till en professionell hantverkare för hjälp. Allmänna råd angående installation samt information om blandarens användning, rengöring och dess garantivillkor finner du i foldern "important notes on Oras products" som följer med din produkt.
- SK** Ďakujeme za výber produktu Oras. Tento návod pre inštaláciu a údržbu Vás prevedie montážou, funkciou a použitím vodovodnej batérie. Prosíme čítajte návod pozorne ešte pred montážou samotnej batérie a uschovajte pre prípad možnej ďalšej údržby. V prípade výskytu akýchkoľvek problémov s Vašou batériou je profesionálny inštalatér najlepšou možnou voľbou pre asistenciu pri riešení týchto problémov. Informácie ako čistiť, používať vodovodnú batériu a záručné podmienky sú uvedené v brožúre „Important notes on Oras products“, ktorá Vám je dodaná zároveň s výrobkom Oras.

7442CX

EN 1111
 II (ISO 3822) Oras lab.
 100 - 1000 kPa
 0.31 l/s (300 kPa)
 250 kPa (0.3 l/s)
 max. +80°C

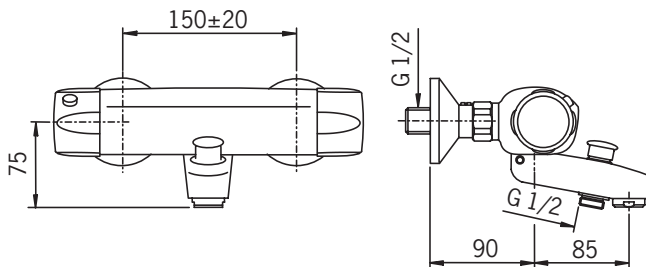

7442CY

EN 1111
 II (ISO 3822) Oras lab.
 100 - 1000 kPa
 0.31 l/s (300 kPa)
 250 kPa (0.3 l/s)
 max. +80°C

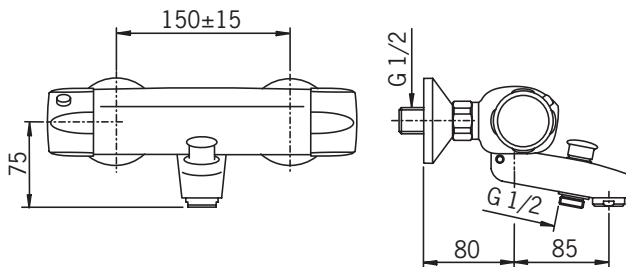

7442X

EN 1111
 II (ISO 3822) Oras lab.
 100 - 1000 kPa
 0.33 l/s (300 kPa)
 250 kPa (0.3 l/s)
 max. +80°C

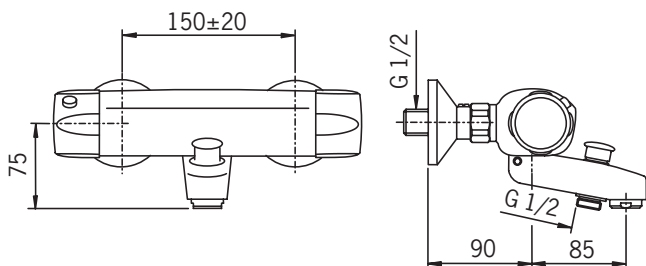

7442Y

EN 1111

II (ISO 3822) Oras lab.

100 - 1000 kPa

0.33 l/s (300 kPa)

250 kPa (0.3 l/s)

max. +80°C

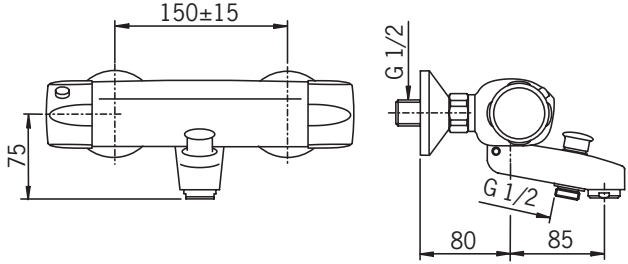

7443

EN 1111

II (ISO 3822) Oras lab.

100 - 1000 kPa

0.33 l/s (300 kPa)

2 kPa (0.3 l/s)

max. +80°C

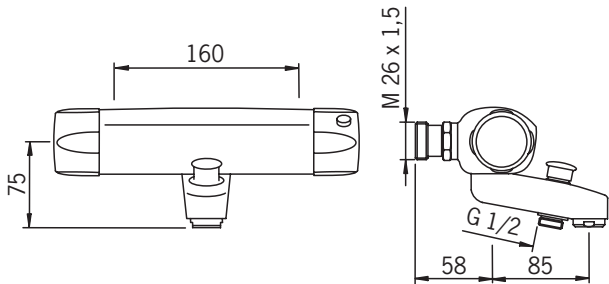

7445

EN 1111

II (ISO 3822) Oras lab.

100 - 1000 kPa

0.32 l/s (300 kPa)

265 kPa (0.3 l/s)

max. +80°C

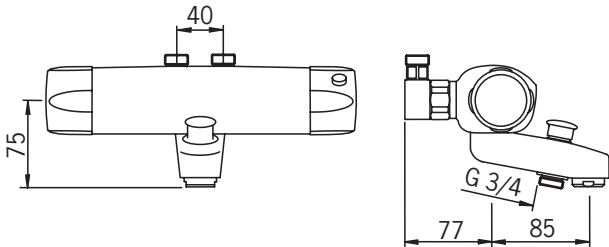

7446X

EN 1111
 I (ISO 3822) Oras lab.
 100 - 1000 kPa
 0.24 l/s (300 kPa)
 200 kPa (0.2 l/s)
 max. +80°C

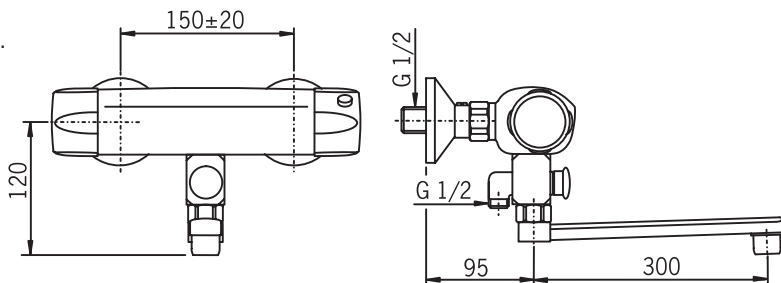

7447X

EN 1111
 I (ISO 3822) Oras lab.
 100 - 1000 kPa
 0.24 l/s (300 kPa)
 200 kPa (0.2 l/s)
 max. +80°C

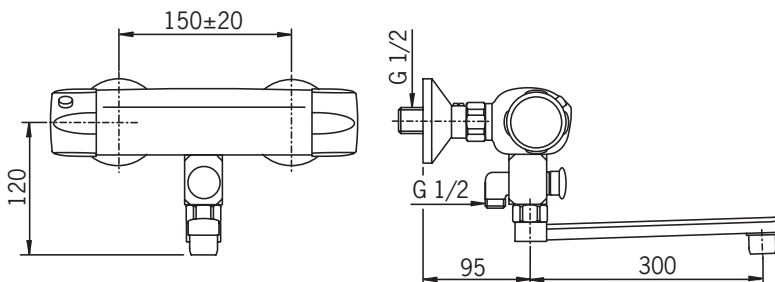

7460

EN 1111
 I (ISO 3822)
 100 - 1000 kPa
 0.28 l/s (300 kPa)
 150 kPa (0.2 l/s)
 max. +80°C

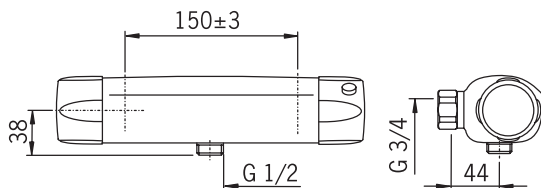

VA VA 1.43/19652

7460CX

EN 1111

I (ISO 3822)

100 - 1000 kPa

0.28 l/s (300 kPa)

150 kPa (0.2 l/s)

max. +80°C

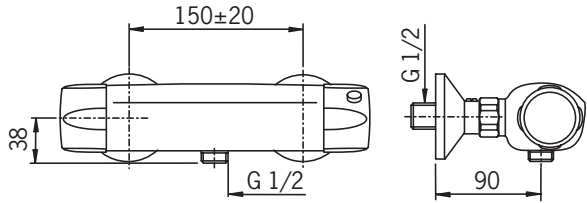

7460CY

EN 1111

I (ISO 3822)

100 - 1000 kPa

0.28 l/s (300 kPa)

150 kPa (0.2 l/s)

max. +80°C

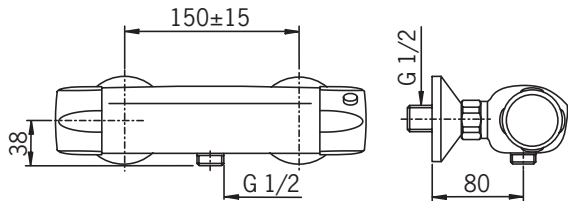

7460X

EN 1111

I (ISO 3822)

100 - 1000 kPa

0.28 l/s (300 kPa)

150 kPa (0.2 l/s)

max. +80°C

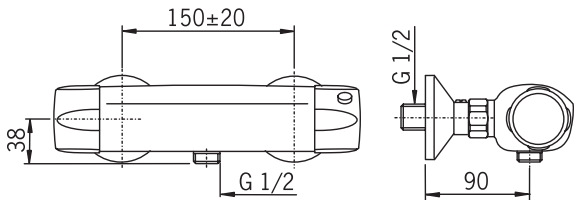

VA 1.43/19652

7460Y

EN 1111
I (ISO 3822)
100 - 1000 kPa
0.28 l/s (300 kPa)
150 kPa (0.2 l/s)
max. +80°C

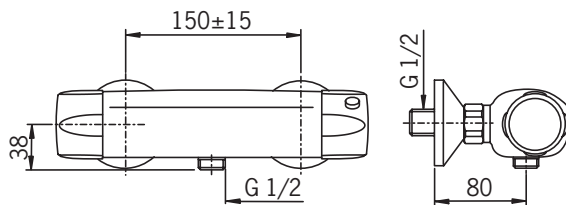

VA 1.43/19652
KIWA K13876/03

7461

EN 1111
I (ISO 3822)
100 - 1000 kPa
0.28 l/s (300 kPa)
150 kPa (0.2 l/s)
max. +80°C

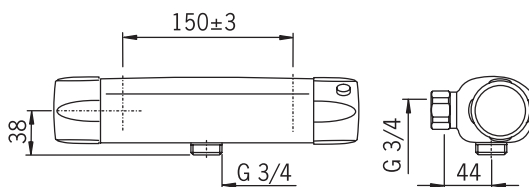

VA 1.43/19652
STF VTT-RTH-00084-10
Sintef Nr. 1548

7461CY

EN 1111
I (ISO 3822) Oras lab.
100 - 1000 kPa
0.28 l/s (300 kPa)
150 kPa (0.2 l/s)
max. +80°C

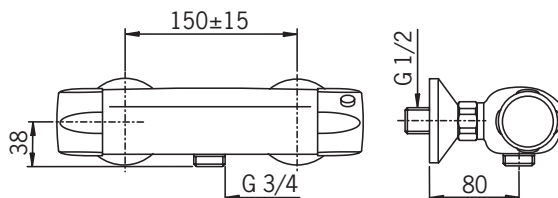

7461X

EN 1111
I (ISO 3822)
100 - 1000 kPa
0.28 l/s (300 kPa)
150 kPa (0.2 l/s)
max. +80°C

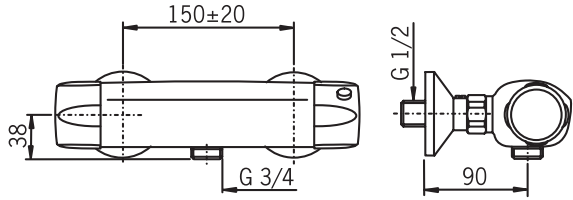

VA 1.43/19652
Sintef Nr. 1548

7462

EN 1111
II (ISO 3822)
100 - 1000 kPa
0.33 l/s (300 kPa)
250 kPa (0.3 l/s)
max. +80°C

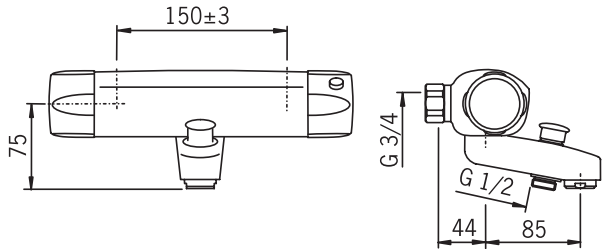

Sintef Nr. 1549

7462CX

EN 1111
II (ISO 3822) Oras lab.
100 - 1000 kPa
0.31 l/s (300 kPa)
250 kPa (0.3 l/s)
max. +80°C

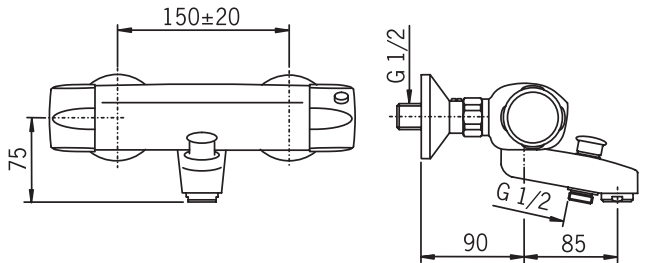

7462CY

EN 1111
 II (ISO 3822)
 100 - 1000 kPa
 0.31 l/s (300 kPa)
 250 kPa (0.3 l/s)
 max. +80°C

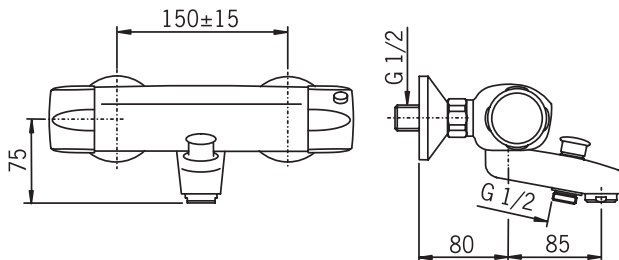

LGA P-IX 19364/IDB

7462X

EN 1111
 II (ISO 3822)
 100 - 1000 kPa
 0.33 l/s (300 kPa)
 250 kPa (0.3 l/s)
 max. +80°C

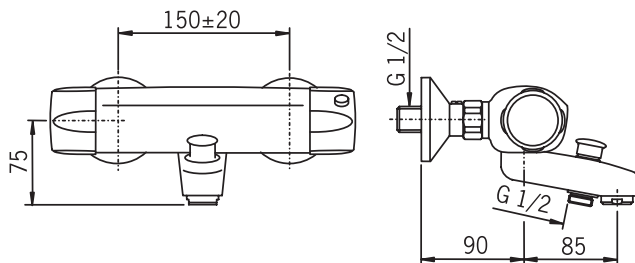

Sintef Nr. 1549

7462Y

EN 1111
 II (ISO 3822)
 100 - 1000 kPa
 0.33 l/s (300 kPa)
 250 kPa (0.3 l/s)
 max. +80°C

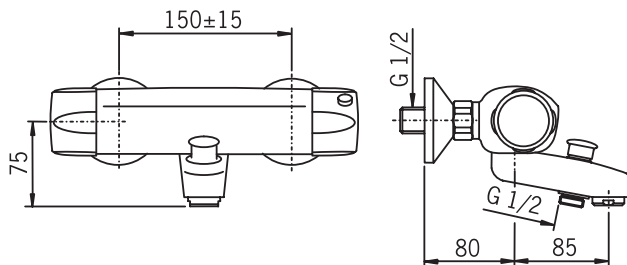

KIWA K13876/03
 Sintef Nr. 1549

7463

EN 1111
 I (ISO 3822) Oras lab.
 100 - 1000 kPa
 0.28 l/s (300 kPa)
 150 kPa (0.2 l/s)
 max. +80°C

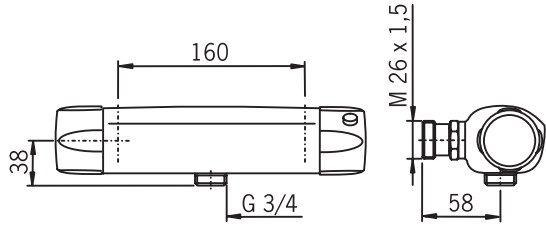

7464

EN 1111
 I (ISO 3822) Oras lab.
 100 - 1000 kPa
 0.28 l/s (300 kPa)
 150 kPa (0.2 l/s)
 max. +80°C

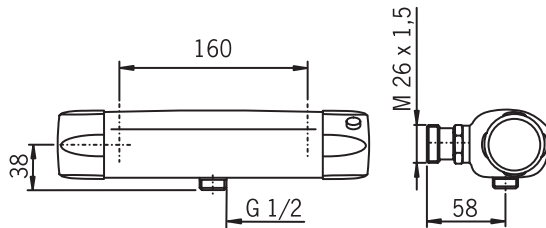

7465

EN 1111
 I (ISO 3822) Oras lab.
 100 - 1000 kPa
 0.27 l/s (300 kPa)
 160 kPa (0.2 l/s)
 max. +80°C

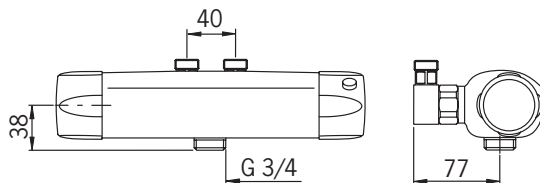

7466

EN 1111

I (ISO 3822) Oras lab.

100 - 1000 kPa

0.27 l/s (300 kPa)

160 kPa (0.2 l/s)

max. +80°C

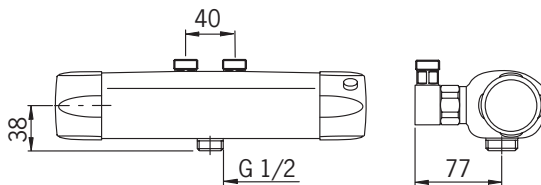

7456

EN 1111

I (ISO 3822) Oras lab.

100 - 1000 kPa

0.28 l/s (300 kPa)

150 kPa (0.2 l/s)

max. +80°C

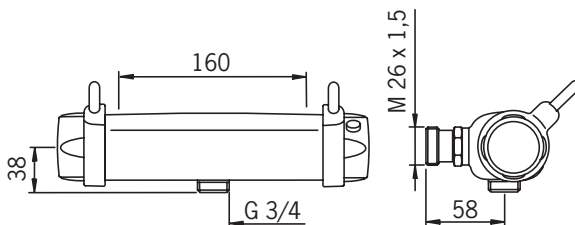

7467

EN 1111

I (ISO 3822) Oras lab.

100 - 1000 kPa

0.28 l/s (300 kPa)

150 kPa (0.2 l/s)

max. +80°C

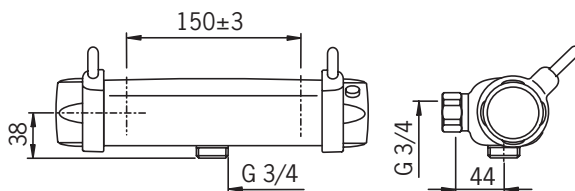

VA VA 1.43/19652

STF VTT-RTH-00084-10

7467CY

EN 1111
I (ISO 3822)
100 - 1000 kPa
0.28 l/s (300 kPa)
150 kPa (0.2 l/s)
max. +80°C

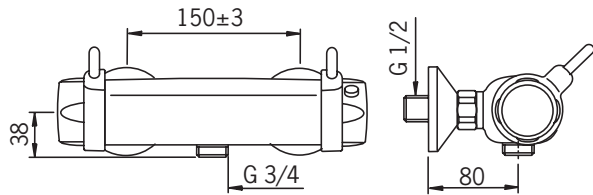

VA 1.43/19652

7468

EN 1111
I (ISO 3822) Oras lab.
100 - 1000 kPa
0.26 l/s (300 kPa)
180 kPa (0.2 l/s)
max. +80°C

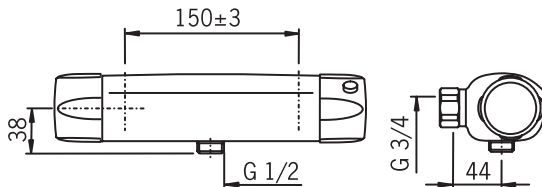

7468CX

EN 1111
I (ISO 3822) Oras lab.
100 - 1000 kPa
0.26 l/s (300 kPa)
180 kPa (0.2 l/s)
max. +80°C

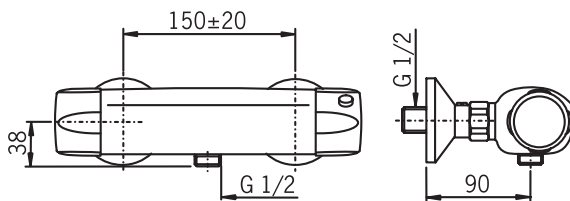

7468CY

EN 1111
I (ISO 3822)
100 - 1000 kPa
0.26 l/s (300 kPa)
180 kPa (0.2 l/s)
max. +80°C

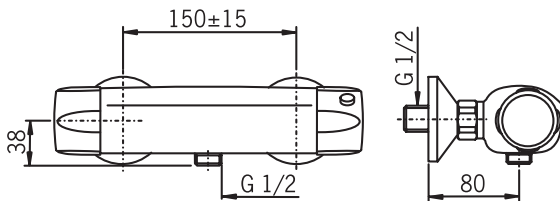

LGA P-IX 19364/IDB

7469

EN 1111
I (ISO 3822) Oras lab.
100 - 1000 kPa
0.28 l/s (300 kPa)
150 kPa (0.2 l/s)
max. +80°C

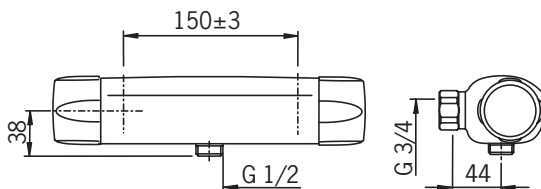

MCA-C-5

7470

EN 1111
I (ISO 3822) Oras lab.
100 - 1000 kPa
0.28 l/s (300 kPa)
150 kPa (0.2 l/s)
max. +80°C

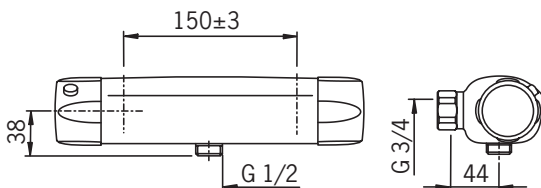

7470CX

EN 1111

I (ISO 3822) Oras lab.

100 - 1000 kPa

0.28 l/s (300 kPa)

150 kPa (0.2 l/s)

max. +80°C

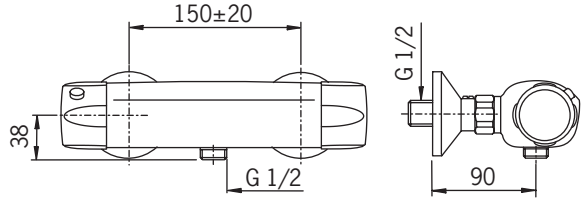

7470CY

EN 1111

I (ISO 3822) Oras lab.

100 - 1000 kPa

0.28 l/s (300 kPa)

150 kPa (0.2 l/s)

max. +80°C

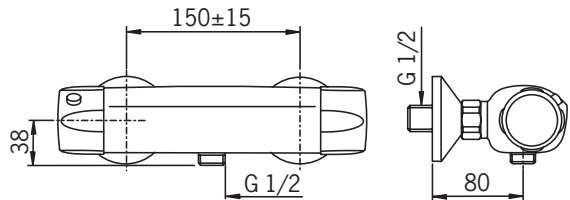

7470X

EN 1111

I (ISO 3822) Oras lab.

100 - 1000 kPa

0.28 l/s (300 kPa)

150 kPa (0.2 l/s)

max. +80°C

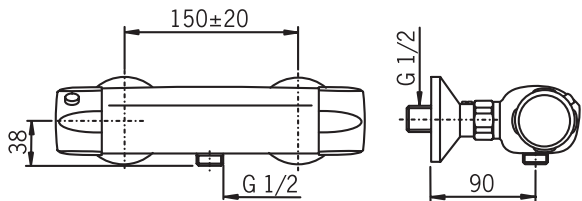

7470Y

EN 1111
I (ISO 3822) Oras lab.
100 - 1000 kPa
0.28 l/s (300 kPa)
150 kPa (0.2 l/s)
max. +80°C

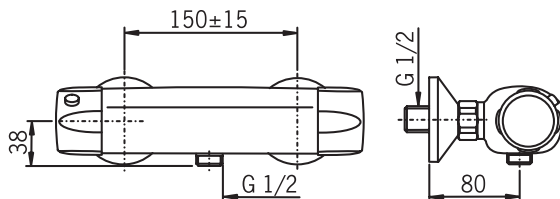

KIWA K13876/03

7471

EN 1111
I (ISO 3822)
100 - 1000 kPa
0.28 l/s (300 kPa)
150 kPa (0.2 l/s)
max. +80°C

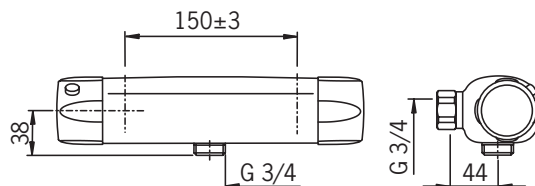

VA VA 1.43/19652
STF VTT-RTH-00084-10

7471Y

EN 1111
I (ISO 3822)
100 - 1000 kPa
0.28 l/s (300 kPa)
150 kPa (0.2 l/s)
max. +80°C

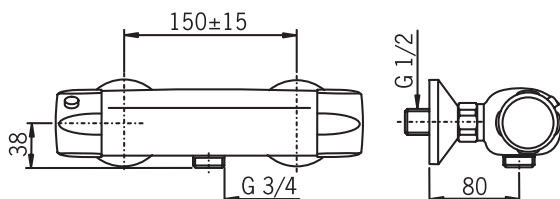

VA VA 1.43/19652
KIWA K13876/03

7478CY

EN 1111
I (ISO 3822) Oras lab.
100 - 1000 kPa
0.26 l/s (300 kPa)
180 kPa (0.3 l/s)
max. +80°C

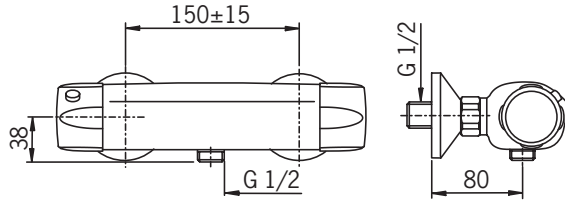

7484

EN 1111
I (ISO 3822) Oras lab.
100 - 1000 kPa
0.26 l/s (300 kPa)
175 kPa (0.2 l/s)
max. +80°C

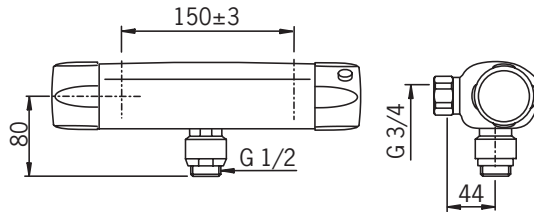

STF VTT-RTH-00084-10

7485

EN 1111
I (ISO 3822)
100 - 1000 kPa
0.26 l/s (300 kPa)
175 kPa (0.2 l/s)
max. +80°C

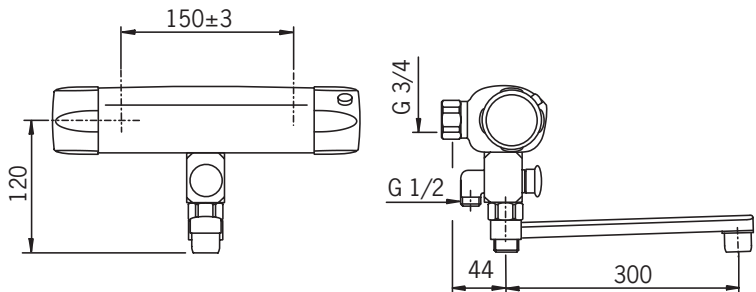

STF VTT-RTH-00084-10

Installation

CZ Montáž
DE Montage
DK Installation
EE Paigaldus
ES Montaje

FI Asennus
FR Installation
IT Montaggio
LT Montavimas

LV Montāža
NL Installatie
NO Montering
PL Instalacja

RO Instalare
RU Установка
SE Installation
SK Inštalácia

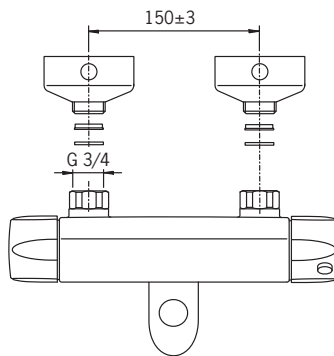
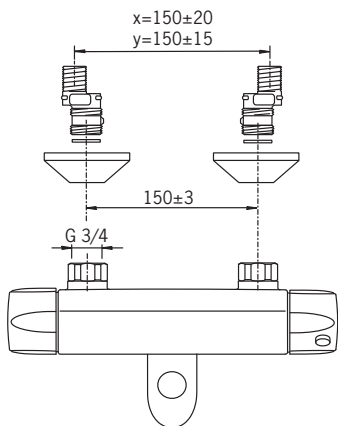
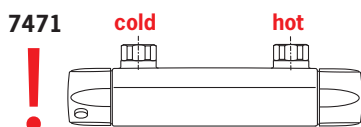
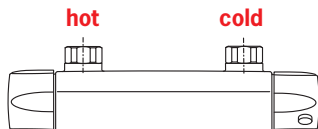

(SE)

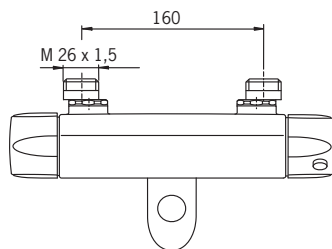

(SE)

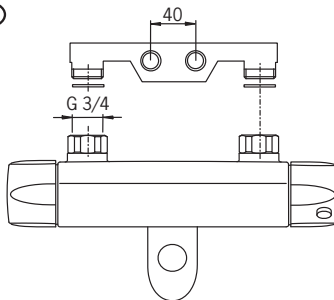

Installation

CZ Montáž	FI Asennus	LV Montāža	RO Instalare
DE Montage	FR Installation	NL Installatie	RU Установка
DK Installation	IT Montaggio	NO Montering	SE Installation
EE Paigaldus	LT Montavimas	PL Instalacja	SK Inštalácia
ES Montaje			

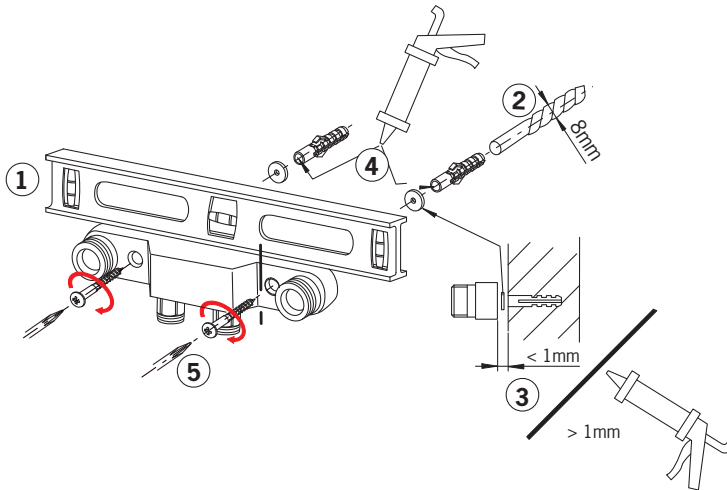
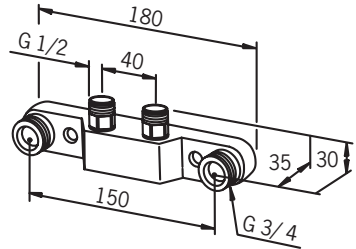

Denna produkt är anpassad till Branschregler Säker Vatteninstallation. Oras garanterar produktens funktion om branschreglerna och produktens monteringsanvisningar följs.

Cleaning the faucet

CZ Čištění baterie

DE Reinigung der Armatur

DK Rengøring af armaturet

EE Puhastamine

ES Limpieza de la grifería

FI Puhdistus

FR Nettoyage du robinet

IT Pulizia della rubinetteria

LT Maišytuvo valymas

LV Krāna tīrīšana

NL Reinigen van de kraan

NO Rengjøring av kranen

PL Czyszczenie baterii

RO Curățire

RU Чистка смесителя

SE Rengöring av blandarna

SK Čistenie vodovodnej batérie

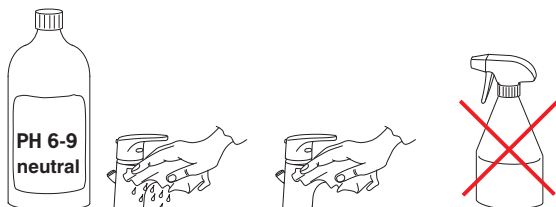

Operation

CZ Funkce

DE Funktion

DK Betjening

EE Toimimine

ES Servicio

FI Toiminta

FR Utilisation

IT Funzionamento

LT Veikimo principas

LV Darbības princips

NL Bediening

NO Funksjon

PL Działanie

RO Funcționare

RU Принцип действия

SE Funktion

SK Prevádzka

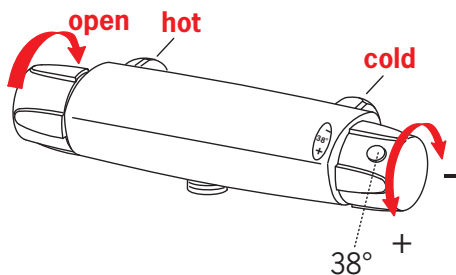

SERVICE 1: Temperature adjustment

CZ Regulátor teploty	LT Temperatūros reguliavimas
DE Temperatureinstellung am Montageort	LV Temperatūras iestādīšana
DK Justering af temperaturen på installationsstedet	NL Temperatuursinstelling
EE Temperatuuri seadmine vajadusel	NO Justering av temperaturen ved sperreknappens
ES Ajuste de la temperatura en el lugar de montaje	PL Regulacja temperatury
FI Lämpötilan säätö tarvittaessa	RO Reglarea temperaturii
FR Limitation de la température	RU Регулировка температуры
IT Regolazione della temperatura sul luogo del montaggio	SE Justering av blandningstemperatur
	SK Nastavenie teploty

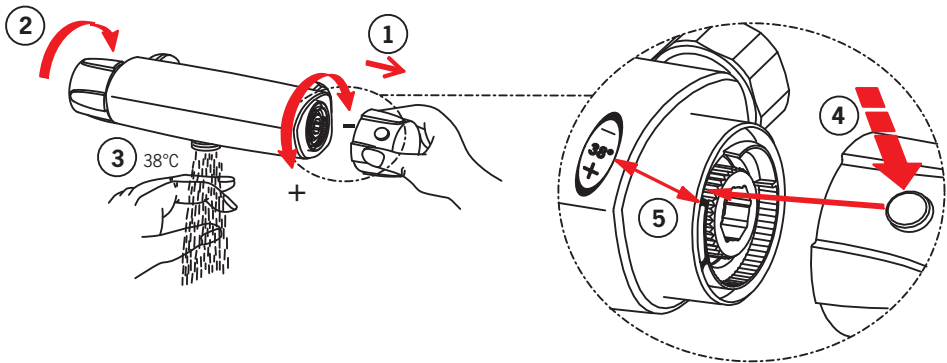

Cleaning/changing the litter filters

CZ Čištění/Výměna filtrů	LV Dubļu filtru tīrīšana/maiņa
DE Reinigung/Wechsel der Filter	NL Reinigen/veranderen van de filters
DK Rensning/udskiftning af filtre	NO Rensing/bytting av filter
EE Prügipüüdu puhastamine/vahetamine	PL Czyszczenie/wymiana filtra
ES Limpieza/cambio de los filtros	RO Curățirea/inlocuirea filtrelor
FI Roskasiivilöiden puhdistaminen/vaihtaminen	RU Очистка и замена уплотнительных фильтро
FR Nettoyage/changement des filtres	SE Rengöring/byte av smutsfilter
IT Pulizia/sostituzione dei filtri	SK Čistenie/výmena odpadových filtrov
LT Filtrų valymas ir pakeitimas	

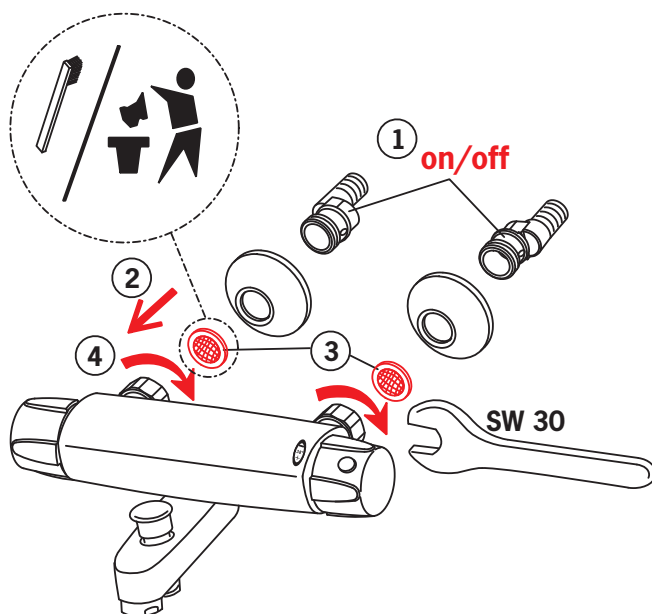

To change the cartridge

CZ Výměna kartuše

DE Ein- und Ausbau der Kartusche

DK Udskiftning af reguleringskassette (unit)

EE Seadeosa vahetus

ES Montaje del cartucho

FI Säätöosan vaihto

FR Montage et démontage de la cartouche

IT Montaggio della cartuccia

LT Valdančiosios kasetės pakeitimas

LV Regulēšanas mehānisma kasetes maiņa

NL Vervangen van het keramische binnenwerk

NO Skifting av kassett

PL Wymiana modułu sterującego

RO Înlocuirea cartușului

RU Замена регулировочного блока

SE Byte av kassett

SK Výměna kartuše

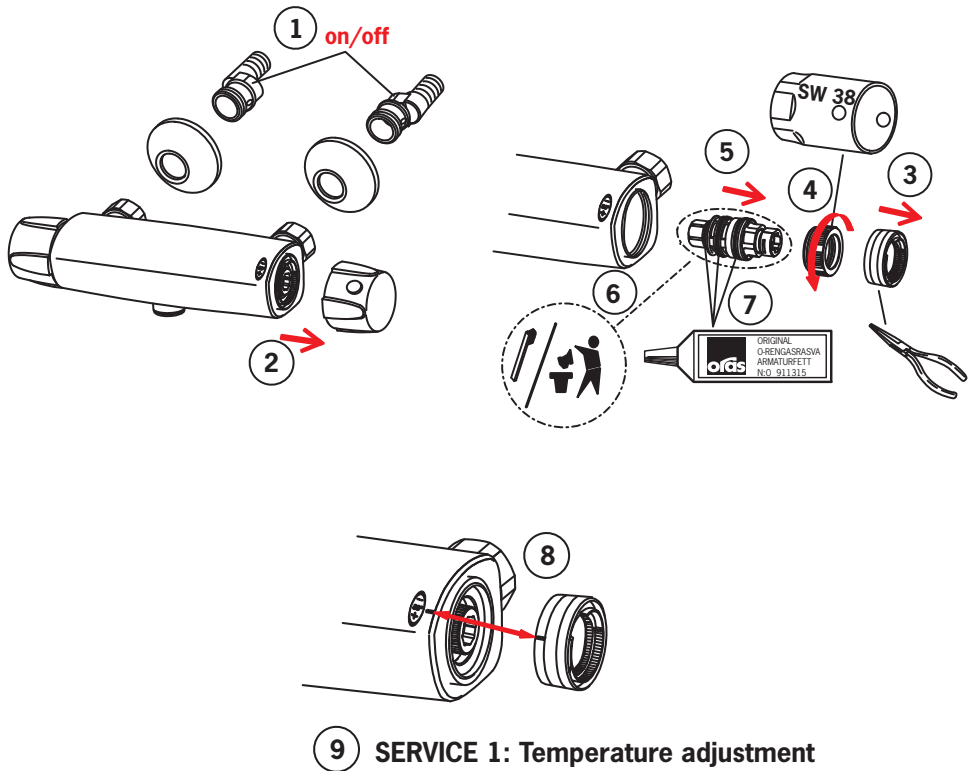

Changing the operating valve

CZ Výměna pracovního ventilu	LT Vandens srauto reguliavimo ventilio pakeitimas
DE Auswechseln der keramischen Oberteile	LV Ūdens plūsmas ventīļa maiņa
DK Udskiftning af topstykker	NL Vervangen van de werkingsklep
EE Seadeventiili vahetus	NO Bytting av overdel
ES Recambio del cartucho del monoblock	PL Wymiana zaworu regulacyjnego
FI Käyttöventtiilin vaihto	RO Înlocuirea ventilului de operare
FR Changement de la tête ceramique eau chaude ou eau froide du grand bec	RU Замена узла управления потоком воды
IT Sostituzione dei vitoni in ceramica	SE Byte av kranöverdel
	SK Výmena prevádzkového ventilu

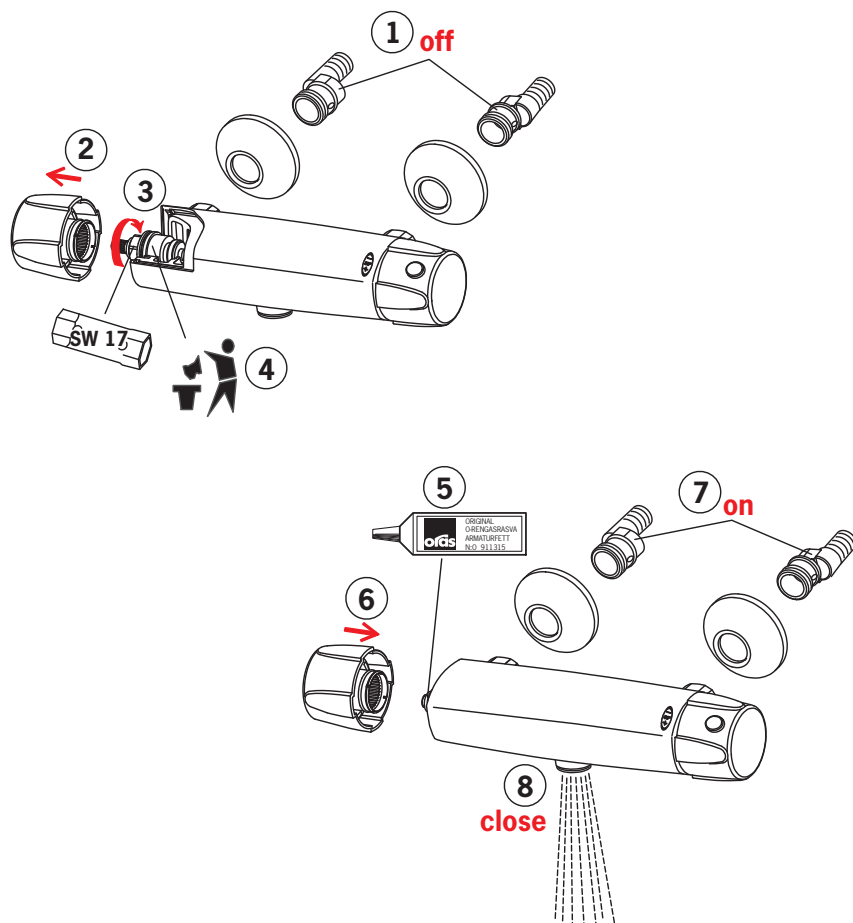

Spare parts

CZ Náhradní díly	FI Varaosat	LV Rezerves daļas	RO Piese de schimb
DE Ersatzteile	FR Pièces détachées	NL Reserve-onderdelen	RU Запасные части
DK Reservedele	IT Pezzi di ricambio	NO Reservedeler	SE Reservdelar
EE Varuosad	LT Atsarginės dalys	PL Części zamienne	SK Náhradné diely
ES Piezas de recambio			

**7442X, 7442Y, 7445, 7446X, 7447X,
7448, 7449, 7460, 7460X, 7460Y,
7461, 7461X, 7462, 7462Y, 7462X,
7465, 7466, 7468, 7470, 7470X, 7470Y,
7471, 7471Y, 7484, 7485, 7495**

- 1 109089V
- 2 178780V
- 3 178783V
- 4 178794V
- 5 178796V
- 6 178375V

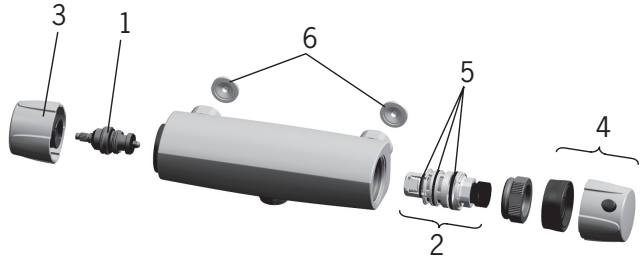

**7442CX, 7442CY, 7460CX, 7460CY,
7461CY, 7462CX, 7462CY, 7468CX,
7468CY, 7470CX, 7470CY, 7478CY**

- 1 109898
- 2 178780V
- 3 178783V
- 4 178794V
- 5 178796V
- 6 178375V

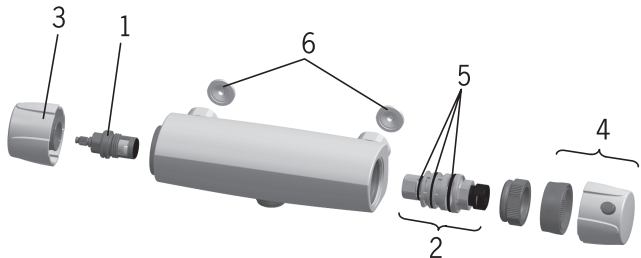

Spare parts

CZ Náhradní díly	FI Varaosat	LV Rezerves daļas	RO Piese de schimb
DE Ersatzteile	FR Pièces détachées	NL Reserve-onderdelen	RU Запасные части
DK Reservedele	IT Pezzi di ricambio	NO Reservedeler	SE Reservdelar
EE Varuosad	LT Atsarginės dalys	PL Części zamienne	SK Náhradné diely
ES Piezas de recambio			

7443, 7463, 7464

- 1 109089V
- 2 178780V
- 3 178783V
- 4 178794V
- 5 178796V
- 6 198094/2

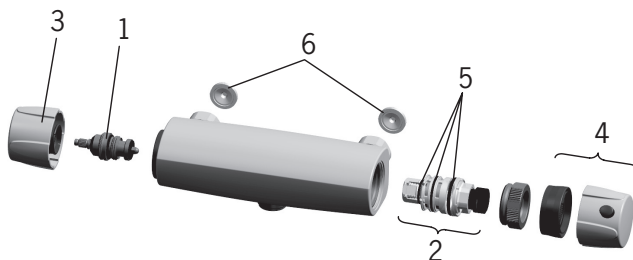

7467CY, 7467, 7456

- 1 109898
- 2 178780V
- 3 178783V
- 4 178794V
- 5 178796V
- 6 178375V
- 6 198094/2 (7456)
- 7 600268V

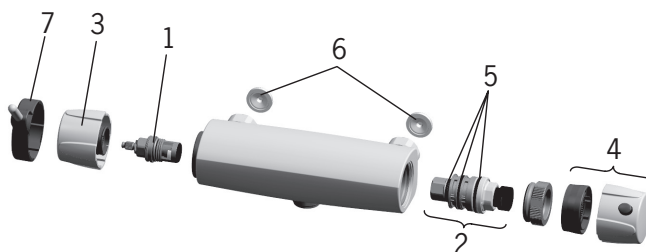

Spare parts

CZ Náhradní díly
DE Ersatzteile
DK Reservedele
EE Varuosad
ES Piezas de recambio

FI Varaosat
FR Pièces détachées
IT Pezzi di ricambio
LT Atsarginės dalys

LV Rezerves daļas
NL Reserve-onderdelen
NO Reservedeler
PL Części zamienne

RO Piese de schimb
RU Запасные части
SE Reservdelar
SK Náhradné diely

7469

- 1 109898
- 2 178780V
- 3 178783V
- 4 178797V
- 5 178796V
- 6 178375V

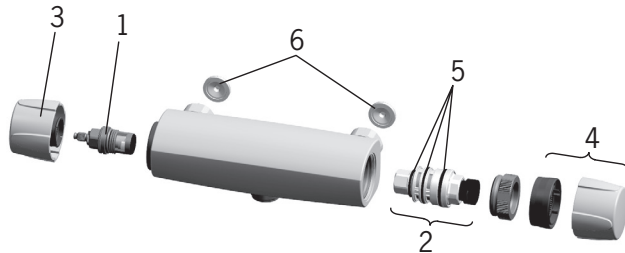

Oras is a significant developer, manufacturer and marketer of sanitary fittings. Since its founding in 1945 the company has introduced high-quality design products featuring user-friendly technical solutions that contribute to savings of water and energy. As early as in the in the 1990s, Oras introduced the first touchless electronic faucets in the market.

Oras is owned by Oras Invest, a family company. In September 2013 Oras acquired Hansa Metallwerke AG, a German faucet manufacturer, with its subsidiaries, and together the companies form the new Oras Group. The head office of the Group is located in Rauma, Finland, and the company's factories are located in Rauma, Burglengenfeld (Germany), Kralovice (Czech Republic) and Olesno (Poland). The Group employs about 1 400 people.

Det Norske Veritas Certification OY/AB certifies that the Quality Management System of Oras Oy in Rauma Finland, conforms to the ISO 9001, the Environmental Management System to the ISO 14001 standard and the Occupational Health and Safety System to the OHSAS 18001 standard. The certificates are valid for development, manufacture, marketing, sales and after sales services of faucets, accessories and valves.

The TÜV CERT Certification Body of TÜV NORD Zertifizierungs- und Umweltgutachter Gesellschaft mbH certifies that the Quality Management System of Oras Olesno Sp. z o.o. in Olesno Poland, conforms to the ISO 9001, the Environmental Management System to the ISO 14001 standard and the Occupational Health and Safety System to the OHSAS 18001 standard. The certificates are valid for manufacture, storage, marketing, sales and after sales services of faucets, valves and accessories.



ORAS GROUP
Isometsäntie 2, P.O. Box 40
FI-26101 Rauma
Finland
Tel. +358 2 83 161
Fax +358 2 831 6300
Info.Finland@oras.com



www.oras.com

945933/05/14