

Sim Flex™ selvregulerende cirkulationspumper

Energiforbrug
helt ned til
4 watt

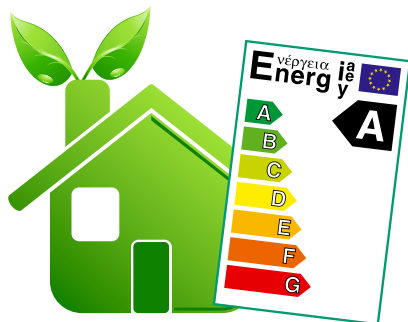

VVS nr.

SimFlex 15-40C 3Q 38 0320 140

SimFlex 25-40C 3Q 38 0320 241

SimFlex 32-40C 3Q 38 0320 341

1x230 V, 50Hz, IEC38	PI [W]	I [A]
Auto min.	4,5	0,063
Auto max.	23,1	0,23
Speed Min - Max	6,9-23,5	0,084-0,263
Medium Temperature	+2°C	+95°C
Kg (netto)	2,8	

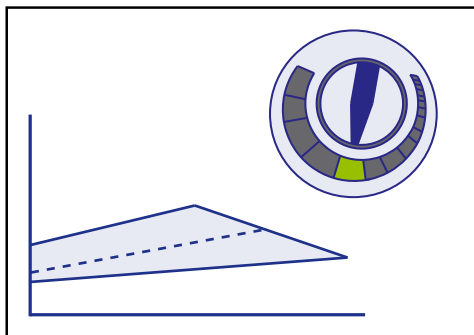
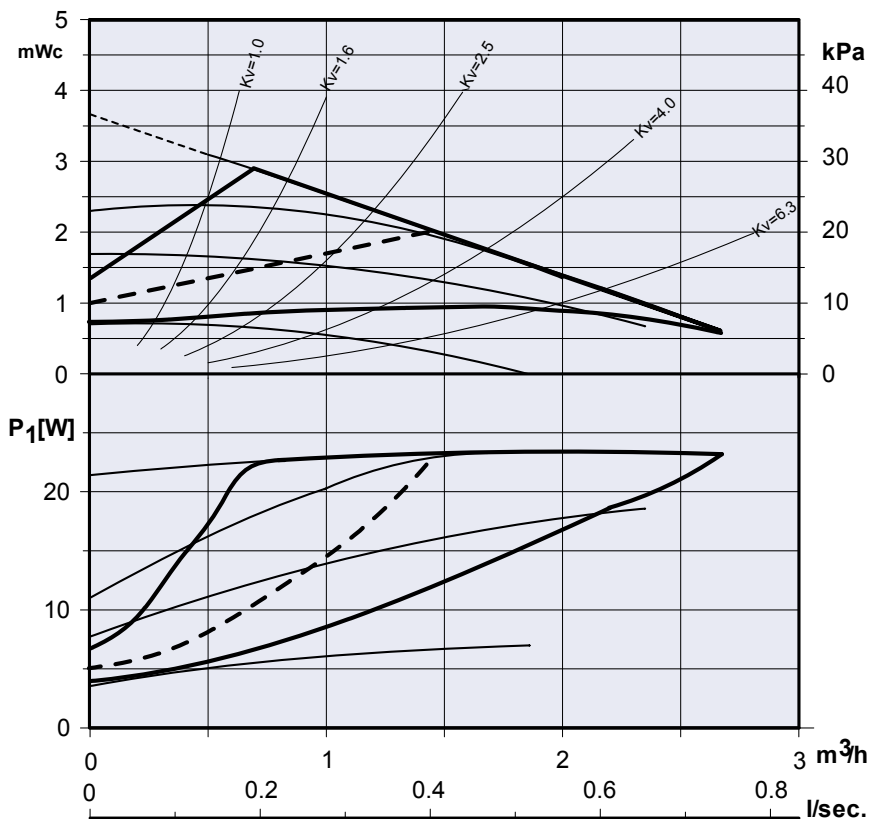

Elektrisk tilslutning

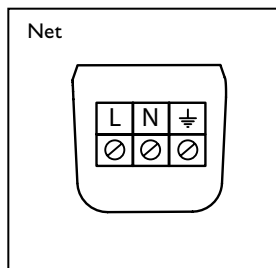

Model	H (mm)	RP/BSPF
15-40C-3Q	130	1/2"
25-40C-3Q	130/180	1"
32-40C-3Q	180	1 1/4"

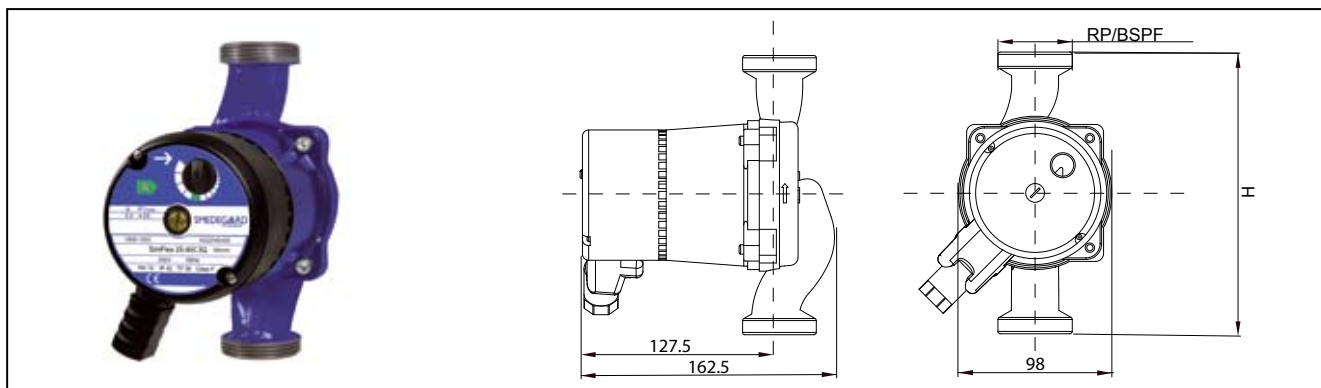
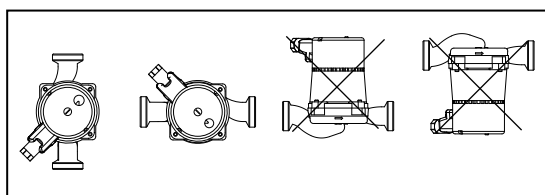

Sim Flex™ selvregulerende cirkulationspumper

Energiforbrug
helt ned til
4 watt

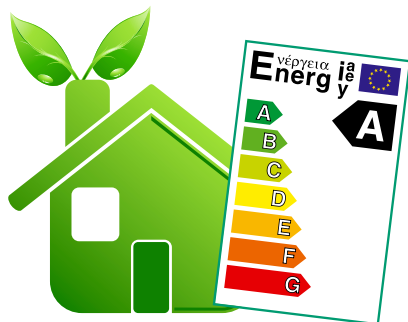

VVS nr.

SimFlex 15-60C 3Q 38 0320 160

SimFlex 25-60C 3Q 38 0320 261

SimFlex 32-60C 3Q 38 0320 361

Ix230 V, 50Hz, IEC38	PI [W]	I [A]
Auto min.	3,86	0,0525
Auto max.	47,4	0,483
Speed Min - Max	6,66-45,2	0,08-0,442
Medium Temperature	+2°C	+95°C
Kg (netto)	2,8	

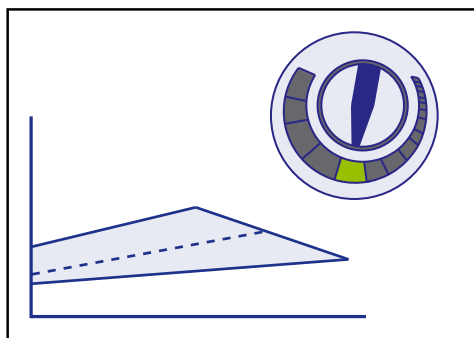
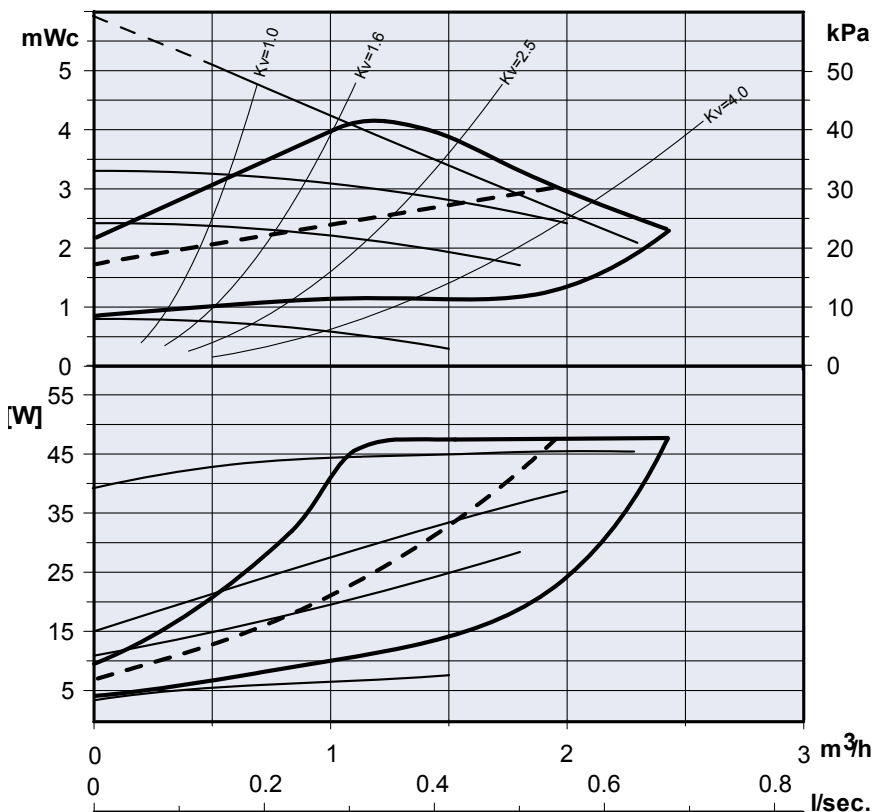

Elektrisk tilslutning

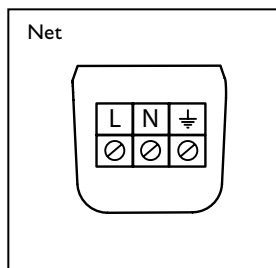

Model	H (mm)	RP/BSPF
15-60C-3Q	130	1/2"
25-60C-3Q	130/180	1"
32-60C-3Q	180	1 1/4"

