

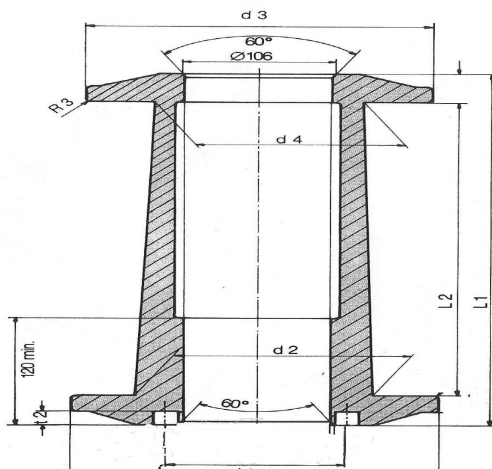

BOBINA TRONCOCONICA IN PLASTICA - 200 KG



Portata: 200 Kg circa

Ø esterno = 400

Ø interno = 100

h = 630

(U.M. = mm)