



CATALOGO | CATALOGUE

INSERTI FILETTATI RIVET NUTS

 RIVIT.IT 



L'AZIENDA THE COMPANY

Rivit è conosciuta in Italia come una delle aziende leader nella produzione e distribuzione di sistemi per il fissaggio e utensili per l'assemblaggio e la lavorazione della lamiera.

Nata nel 1973, è arrivata a sviluppare due macro divisioni: industria ed edilizia, con particolare attenzione ai settori carrozzeria industriale, elettronica, elettrodomestici, lavorazione lamiera, arredamenti metallici, lattoneria, coperture metalliche, condizionamento, infissi metallici.

L'azienda punta oggi con decisione al mercato internazionale, per misurarsi con nuove sfide e ampliare le proprie strategie di partnership e di mercato. A questi nuovi progetti Rivit si è preparata dotandosi di un magazzino automatico che garantisce e supporta un sistema logistico all'avanguardia, con l'obiettivo di far fronte alle esigenze di un mercato in espansione e con sempre maggiori esigenze.

Rivit is an Italian leading Company for what concerns production and distribution of fastening systems and relevant tools, for sheet metal working and assembling. Founded in 1973, Rivit has come to set the Company core business in two separate macro-divisions: industry and building, with particular attention to the fields of industrial body shop, electronics, household appliances, sheet metal working, metal furnishings, roofing, metal roofing, air conditioning and metal frames.

Nowadays Rivit strongly aims to the international market, to challenge new situations and to widen its own strategies of partnership and marketing. To be able to develop these ambitious projects, Rivit prepared itself with an advanced logistics including an automatic warehouse; this new setting grants and supports a state-of-the-art logistic system, and allows Rivit to meet all the requirements of the Customers, which are getting more and more demanding.



Sede Company



Vista dall'alto Aerial view



Lato shop Shop side



Entrata Entrance

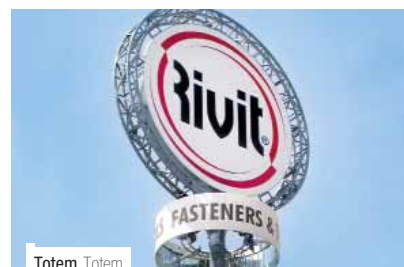

Totem Totem



CERTIFICAZIONI CERTIFICATIONS

Rivit assicura alla propria clientela elevati standard qualitativi dei propri prodotti e servizi, impegno che le ha consentito di ottenere la certificazione del Sistema di Gestione Qualità in conformità alla norma UNI EN ISO 9001:2008. Certificazione che viene annualmente verificata dal Cermet, ente certificatore italiano, membro del gruppo Kiwa.

Rivit inoltre ha voluto certificare volontariamente attraverso l'ECM, ente specializzato nelle validazioni degli utensili, che tutte le sue rivettatrici siano conformi alle direttive europee, in modo particolare alla Direttiva Macchine 2006/42/CE.

In ottemperanza al processo di controllo qualità dei prodotti in entrata, Rivit esegue i test nel suo laboratorio prove meccaniche interno, dove personale specializzato si assicura che gli standard richiesti siano soddisfatti.

Rivit assures its customers high quality standards of its products and services, a commitment that has enabled it to obtain the certification of the Quality Management System in compliance with UNI EN ISO 9001:2008. Certification which is annually verified by Cermet, Italian certification body, member of the Kiwa group.

Rivit also wanted to voluntarily certify through the ECM, an organization specialized in the validation of the tools, that all his riveting comply with the European Directives, in particular Directive 2006/42/EC.

In accordance with the process of quality control of incoming products, Rivit runs the tests in his laboratory mechanical tests inside, where specialized staff will ensure that the required standards are met.



Laboratorio prove Test lab



Test prodotti Products tests



Selezionatrice Sorting machine



Controlli meccanici Mechanical testing



Certificazione Certification



Certificazione Certification



Certificazione Certification



SODDISFAZIONE DEL CLIENTE

CUSTOMER SATISFACTION

Rivit crede fortemente nei servizi di assistenza vendita e post vendita dedicati ai clienti. Tutte le sue aree sono state progettate per offrire supporto tecnico ai clienti in ogni momento dell'attività lavorativa, con personale qualificato e competente.

Rivit si pone come obiettivo strategico la soddisfazione dei propri clienti, ecco perchè le persone che ne fanno parte sono impegnate, tutti i giorni, nel miglioramento dei prodotti e dei servizi, non dimenticando mai che è la qualità che rende soddisfatto il cliente.

Rivit strongly believes in pre and post sales support services dedicated to the Customer. Our Company structure is organised in order to offer technical support to our Customers in every phase of their work, thanks to our very qualified staff.

Rivit's goal is the satisfaction of our Customers, therefore all our members are occupied every day in the developing of the products and services, never forgetting that high quality keeps Customer satisfied.



Reception Reception



Sala meeting Meeting room



Ufficio marketing Marketing office



Uffici Offices





MAGAZZINO AUTOMATICO AUTOMATIC WAREHOUSE

Ma il cuore nevralgico dell'azienda è rappresentato dal magazzino automatico, ospitato in una torre di 18 metri di altezza e 90 metri di lunghezza dove operano i due traslo-elevatori. All'interno sono collocati 24.000 vassoi, suddivisi in due corridoi, che possono contenere fino a 100.000 referenze. Dal momento che oggi Rivit movimentata oltre trentamila articoli, le prospettive di crescita e la varietà degli articoli a stock sono considerate obiettivi irrinunciabili dall'azienda, che ha scelto un magazzino automatico a vassoi multireferenza per ottimizzare le attività di picking.

La rapida e precisa gestione logistica degli articoli a magazzino si inserisce nella logica di una politica commerciale che si pone come obiettivo la maggior velocità e precisione nella gestione degli ordini, per poter garantire esternamente tempi di evasione di 48 ore.

But the nerve centre of the Company is the automatic warehouse with its two trasloelevatori, located in a 18 meter high and 90 meter long tower. Inside there are 24,000 trays, divided along two corridors, that can contain up to 100,000 references. As today Rivit is already managing over 30,000 items, the perspectives of growth and the variety of stock items are considered very important targets by the Company, that has chosen an automatic warehouse with trays to optimize the activities of picking.

The quick and precise logistic management of the stock items is part of the commercial policy of the Company, which aims to the most precise and speediest management of the orders, so that they can be executed within 48 hours.



Magazzino Automatic warehouse



Spedizioni Shipments



Confezionamento Packaging



Spedizioni Shipments

RIVIT SHOP E SHOWROOM RIVIT SHOP AND SHOWROOM

Al centro della missione aziendale, resta saldo l'obiettivo della piena soddisfazione delle esigenze del cliente, che diventa per Rivit uno stimolo per crescere e proporsi come vero partner dei propri clienti. Per questo motivo sono state realizzate un'ampia area di vendita, denominata "RIVIT SHOP" e un'altrettanto vasta zona showroom.

In questo spazio i clienti professionisti hanno modo di toccare con mano gli articoli esposti, provarne il funzionamento e valutarne le caratteristiche. Inoltre, per venire incontro alle esigenze tecniche più specifiche, Rivit mette a disposizione personale tecnico specializzato in grado di poter offrire un servizio di consulenza a 360°.

L'area di vendita si propone, quindi, come un vero centro del fissaggio, un punto di riferimento per tutto quello che riguarda il mondo dell'assemblaggio e della deformazione della lamiera.

The core mission of the Company is the full satisfaction of the demands of the Customer, which turns for Rivit into an incentive to grow and become a real partner for its Customers. For this reason a wide area of the building has been dedicated to sales, giving birth to the RIVIT SHOP and the RIVIT SHOWROOM. Inside this space the professional Customers have the opportunity of touching with hand the goods on display, of trying them and of appraising their features. Besides, to meet the more specific technical demands, a 360° specialized technical support is offered by the staff of the shop.

The area of sales can be therefore considered a real centre for fastening systems, and a place of reference for anything concerning the world of sheet metal working.



Showroom Showroom



Rivit shop Rivit shop



PRODUZIONE PRODUCTION

L'area produttiva di Rivit raggruppa vari reparti dedicati alla produzione: stampaggio, assemblaggio, maschiatura e montaggio tools.

The production department of Rivit is divided in different technical areas: stamping, assembling, tapping and tools manufacturing.



Assemblaggio Assembling



Montaggio tools Tools assembling



Assemblaggio Assembling



Lavorazione tools Tools manufacturing



Produzione Production



Stampaggio Stamping



Maschiatura Tapping



RIVIT NEL MONDO

RIVIT AROUND THE WORLD

Rivit nel mondo, con sedi:
RIVIT ITALIA, RIVIT INDIA, RIVIT MAROCCO



Attraverso la rete di distributori in:

Albania, Arabia Saudita, Argentina, Australia, Austria, Belgio, Bosnia Herzegovina, Brasile, Bulgaria, Canada, Cina, Cipro, Colombia, Corea del Sud, Costa Rica, Croazia, Danimarca, Egitto, Emirati Arabi Uniti, Estonia, Finlandia, Francia, Georgia, Germania, Gran Bretagna, Grecia, India, Iran, Israele, Kuwait, Lettonia, Libano, Lituania, Malesia, Malta, Marocco, Messico, Norvegia, Nuova Zelanda, Olanda, Polonia, Portogallo, Qatar, Repubblica Ceca, Romania, Russia, Serbia, Slovacchia, Slovenia, Spagna, Sud Africa, Svezia, Svizzera, Taiwan, Thailandia, Tunisia, Turchia, Ucraina, Ungheria, USA.

Rivit in the world, with offices:

RIVIT ITALIA - RIVIT INDIA - RIVIT MOROCCO

Thru distributors network:

Albania, Argentina, Australia, Austria, Belgium, Bosnia Herzegovina, Brazil, Bulgaria, Canada, China, Cyprus, Colombia, Costa Rica, Croatia, Czech Republic, Denmark, Egypt, Estonia, Finland, France, Georgia, Germany, Greece, Hungary, India, Iran, Israel, Kuwait, Latvia, Lebanon, Lithuania, Malaysia, Malta, Mexico, Morocco, Netherlands, New Zeland, Norway, Poland, Portugal, Qatar, Romania, Russia, Saudi Arabia, Serbia, Slovakia, Slovenia, South Africa, South Korea, Spain, Sweden, Switzerland, Taiwan, Thailand, Tunisia, Turkey, UK, Ukraine, United Arab Emirates, USA.



FIERE EXHIBITIONS

Rivit punta ad incrementare in maniera significativa i contatti e le relazioni di partnership, per cui ha sempre investito molto nella partecipazione a fiere di settore, in Italia e all'estero. In questo modo Rivit ha potuto rendere ancora più manifesti i propri punti di forza: ampiezza e completezza della gamma, qualità dei prodotti, costante innovazione e sviluppo di nuove soluzioni, ampia disponibilità a stock, efficace supporto post vendita.

Every day Rivit focuses on increasing contacts and partnership relations, and to this purpose the Company has always invested in the participation to dedicated exhibitions, both in Italy and abroad.

In this way Rivit made even more manifest its points of strength: wideness and completeness of the range of products, their high quality, constant innovation and development of new solutions, wide stock availability, and effective after-sales service.



HOME AZIENDA

LOGIN

Benvenuto nel portale Rivit.
Contattaci per qualsiasi pro

Indirizzo e-mail*

Password*

Password dimenticata

Non sei ancora regis

Il portale pubblico consente di conoscere Rivit e la sua storia, di essere sempre aggiornati sulle novità e i prodotti relativi a ciascuna delle sue divisioni (lattoneria, industria, infissi, rivendita), di conoscere le fiere a cui partecipa e le offerte speciali in corso.

Navigate quindi sul nostro catalogo virtuale, facendovi guidare dai percorsi fotografici per una ricerca facile e immediata e scoprire la ricca e diversificata gamma dei prodotti Rivit. Le schede prodotto potranno essere corredate di numerose immagini e allegati (video, testi, file pdf ecc.). Nella sezione Area download si possono scaricare i cataloghi in formato pdf, senza che sia necessaria alcuna forma di registrazione.

L'area riservata da accesso all'area B2B, dove è possibile ordinare immediatamente tutti gli articoli presenti sul sito attraverso un carrello semplice e di immediato utilizzo. Ciascun cliente può controllare i propri ordini, visualizzare lo stato delle spedizioni e scaricare documentazione tecnica, schede e manuali nell'apposita area documentale.

Venite ad esplorare il mondo di Rivit!

The web site allows you to get in touch with the Rivit world and its history, to be constantly updated on news and products related to each division (roofing, industry, frames, dealers), on exhibitions and on special offers in progress.

Visit our virtual catalogue, let you drive yourself into our photographic journey and with just a click discover the wide Rivit products range. Products data sheets may be downloaded with several pictures and attachments (videos, texts, pdf files etc.).

In the "Download Area" you can download pdf catalogues with no need for registration.

The restricted area guides you into B2B area, where you can place orders by means of a very easy-to-use and immediate Cart. Each Customer can manage his orders, view the status of shipments and download technical documentation, forms and manuals.





Come and visit the Rivit world!



Inserti filettati fusto liscio aperto - acciaio | Rivet nuts plain shank - steel

Inserti RIVSERT | RIVSERT rivet nuts

Sconto
Discount

	FTC	Acciaio - Fusto cilindrico aperto - Testa tonda Steel - Open cylindrical shank - Dome head	27	
	FRC	Acciaio - Fusto cilindrico aperto - Testa ridotta Steel - Open cylindrical shank - Reduced head	28	
	FRC-P	Acciaio - Fusto cilindrico aperto - Testa ridotta - Foro in pollici Steel - Open cylindrical shank - Reduced head - Inch hole	29	
	FSC	Acciaio - Fusto cilindrico aperto - Testa svasata Steel - Open cylindrical shank - Countersunk head	30	



Inserti filettati fusto zigrinato aperto - acciaio | Rivet nuts knurled shank - steel

Inserti RIVSERT | RIVSERT rivet nuts

	FTC-Z	Acciaio - Fusto cilindrico zigrinato aperto - Testa tonda Steel - Open knurled cylindrical shank - Dome head	31	
	FRC-Z	Acciaio - Fusto cilindrico zigrinato aperto - Testa ridotta Steel - Open knurled cylindrical shank - Reduced head	32	
	FSC-Z	Acciaio - Fusto cilindrico zigrinato aperto - Testa svasata Steel - Open knurled cylindrical shank - Countersunk head	33	



Inserti filettati fusto semiesagonale aperto - acciaio | Rivet nuts semi-hexagonal shank - steel

Inserti RIVSERT | RIVSERT rivet nuts

	FTEP	Acciaio - Fusto semiesagonale aperto - Testa tonda Steel - Open semi-hexagonal shank - Dome head	34	
	FREP	Acciaio - Fusto semiesagonale aperto - Testa ridotta Steel - Open semi-hexagonal shank - Reduced head	35	
	FREP-P	Acciaio - Fusto semiesagonale aperto - Testa ridotta - Esagono in pollici Steel - Open semi-hexagonal shank - Reduced head - Inch hexagon	36	

Inserti filettati fusto esagonale aperto - acciaio | Rivet nuts hexagonal shank - steel



Inserti RIVSERT | RIVSERT rivet nuts

	FTE	Acciaio - Fusto esagonale aperto - Testa tonda Steel - Open hexagonal shank - Dome head	37	
	FRE	Acciaio - Fusto esagonale aperto - Testa ridotta Steel - Open hexagonal shank - Reduced head	38	

Inserti filettati fusto liscio ciechi - acciaio | Closed end rivet nuts plain shank - steel

Inserti RIVSERT | RIVSERT rivet nuts

Sconto
Discount

	SFTC	Acciaio - Fusto cilindrico cieco - Testa tonda Steel - Closed end cylindrical shank - Dome head	39	
	SFSC	Acciaio - Fusto cilindrico cieco - Testa svasata Steel - Closed end cylindrical shank - Countersunk head	40	



Inserti filettati fusto zigrinato ciechi - acciaio | Closed end rivet nuts knurled shank - steel

Inserti RIVSERT | RIVSERT rivet nuts

	SFTC-Z	Acciaio - Fusto cilindrico zigrinato cieco - Testa tonda Steel - Closed end knurled cylindrical shank - Dome head	41	
	SFRC-Z	Acciaio - Fusto cilindrico zigrinato cieco - Testa ridotta Steel - Closed end knurled cylindrical shank - Reduced head	42	
	SFSC-Z	Acciaio - Fusto cilindrico zigrinato cieco - Testa svasata Steel - Closed end knurled cylindrical shank - Countersunk head	43	



Inserti filettati fusto esagonale ciechi - acciaio | Closed end rivet nuts hexagonal shank - steel

Inserti RIVSERT | RIVSERT rivet nuts

	SFTE	Acciaio - Fusto esagonale cieco - Testa tonda Steel - Closed end hexagonal shank - Dome head	44	
	SFRE	Acciaio - Fusto esagonale cieco - Testa ridotta Steel - Closed end hexagonal shank - Reduced head	45	

Inserti filettati fusto liscio aperto - inox A2 | Rivet nuts plain shank - A2 stainless steel

Inserti RIVSERT | RIVSERT rivet nuts

	ITC/A2	Acciaio inox A2 - Fusto cilindrico aperto - Testa tonda A2 s/steel - Open cylindrical shank - Dome head	46	
	IRC/A2	Acciaio inox A2 - Fusto cilindrico aperto - Testa ridotta A2 s/steel - Open cylindrical shank - Reduced head	47	
	IRC-P/A2	Acciaio inox A2 - Fusto cilindrico aperto - Testa ridotta - Foro in pollici A2 s/steel - Open cylindrical shank - Reduced head - Inch hole	48	

Inserti filettati fusto liscio aperto - inox A4 | Rivet nuts plain shank - A4 stainless steel



Inserti RIVSERT | RIVSERT rivet nuts

Sconto
Discount

	ITC/A4	Acciaio inox A4 - Fusto cilindrico aperto - Testa tonda A4 stainless steel - Open cylindrical shank - Dome head	49	
	IRC/A4	Acciaio inox A4 - Fusto cilindrico aperto - Testa ridotta A4 stainless steel - Open cylindrical shank - Reduced head	49	



Inserti filettati fusto zigrinato aperto - inox A2 | Rivet nuts knurled shank - A2 stainless steel

Inserti RIVSERT | RIVSERT rivet nuts

	ITC-Z/A2	Acciaio inox A2 - Fusto cilindrico zigrinato aperto - Testa tonda A2 stainless steel - Open knurled cylindrical shank - Dome head	50	
	IRC-Z/A2	Acciaio inox A2 - Fusto cilindrico zigrinato aperto - Testa ridotta A2 stainless steel - Open knurled cylindrical shank - Reduced head	51	
	ISC-Z/A2	Acciaio inox A2 - Fusto cilindrico zigrinato aperto - Testa svasata A2 stainless steel - Open knurled cylindrical shank - Countersunk head	52	



Inserti filettati fusto semiesagonale aperto - inox A2 | Rivet nuts semi-hexagonal shank - A2 stainless steel

Inserti RIVSERT | RIVSERT rivet nuts

	ITEP/A2	Acciaio inox A2 - Fusto semiesagonale aperto - Testa tonda A2 stainless steel - Open semi-hexagonal shank - Dome head	53	
	IREP/A2	Acciaio inox A2 - Fusto semiesagonale aperto - Testa ridotta A2 stainless steel - Open semi-hexagonal shank - Reduced head	54	

Inserti filettati fusto semiesagonale aperto - inox A4 | Rivet nuts semi-hexagonal shank - A4 stainless steel

Inserti RIVSERT | RIVSERT rivet nuts

	ITEP/A4	Acciaio inox A4 - Fusto semiesagonale aperto - Testa tonda A4 stainless steel - Open semi-hexagonal shank - Dome head	55	
	IREP/A4	Acciaio inox A4 - Fusto semiesagonale aperto - Testa ridotta A4 stainless steel - Open semi-hexagonal shank - Reduced head	55	

Inserti filettati fusto liscio ciechi - inox A2 | Closed end rivet nuts plain shank - A2 stainless steel



Inserti RIVSERT | RIVSERT rivet nuts

	SITC/A2	Acciaio inox A2 - Fusto cilindrico cieco - Testa tonda A2 stainless steel - Closed end cylindrical shank - Dome head	56	
---	----------------	---	-----------	--

Inserti filettati fusto zigrinato ciechi - inox A2 | Closed end rivet nuts knurled shank - A2 s/steel

Inserti RIVSERT | RIVSERT rivet nuts

Sconto
Discount

	SITC-Z/A2	Acciaio inox A2 - Fusto cilindrico zigrinato cieco - Testa tonda A2 stainless steel - Closed end knurled cylindrical shank - Dome head	57	
	SIRC-Z/A2	Acciaio inox A2 - Fusto cilindrico zigrinato cieco - Testa ridotta A2 stainless steel - Closed end knurled cylindrical shank - Reduced head	58	



Inserti filettati fusto semiesagonale ciechi - inox A2 | Closed end rivet nuts semi-hexagonal shank - A2 s/steel

Inserti RIVSERT | RIVSERT rivet nuts

	SITEP/A2	Acciaio inox A2 - Fusto semiesagonale cieco - Testa tonda A2 stainless steel - Closed end semi-hexagonal shank - Dome head	59	
	SIREP/A2	Acciaio inox A2 - Fusto semiesagonale cieco - Testa ridotta A2 stainless steel - Closed end semi-hexagonal shank - Reduced head	60	

Inserti filettati fusto semiesagonale ciechi - inox A4 | Closed end rivet nuts semi-hexagonal shank - A4 s/steel

Inserti RIVSERT | RIVSERT rivet nuts

	SIREP/A4	Acciaio inox A4 - Fusto semiesagonale cieco - Testa ridotta A4 stainless steel - Closed end semi-hexagonal shank - Reduced head	60	
	STREP-G	Acciaio inox A4 - Fusto semiesagonale cieco - Testa tonda - con guarnizione A4 s/steel - Closed end semi-hexagonal shank - Dome head - with underhead	61	

Inserti filettati fusto liscio aperto - alluminio | Rivet nuts plain shank - aluminium

Inserti RIVSERT | RIVSERT rivet nuts

	ATC	Alluminio - Fusto cilindrico aperto - Testa tonda Aluminium - Open cylindrical shank - Dome head	62	
	ARC	Alluminio - Fusto cilindrico aperto - Testa ridotta Aluminium - Open cylindrical shank - Reduced head	63	
	ASC	Alluminio - Fusto cilindrico aperto - Testa svasata Aluminium - Open cylindrical shank - Countersunk head	64	

Inserti filettati fusto liscio ciechi - alluminio | Closed end rivet nuts plain shank - aluminium

Inserti RIVSERT | RIVSERT rivet nuts

	SATC	Alluminio - Fusto cilindrico cieco - Testa tonda Aluminium - Closed end cylindrical shank - Dome head	65	
---	-------------	--	-----------	--

Inserti filettati fusto liscio aperto - ottone | Rivet nuts plain shank - brass

Inserti RIVSERT | RIVSERT rivet nuts

Sconto
Discount



OTC

Ottone - Fusto cilindrico aperto - Testa tonda
Brass - Open cylindrical shank - Dome head

66

Inserti filettati ridotti | Reduced rivet nuts

Inserti THINSERT | THINSERT rivet nuts



FRTH

Acciaio - Fusto cilindrico aperto - Testa ridotta
Steel - Open cylindrical shank - Reduced head

67

Inserti filettati quadri | Square rivet nuts

Inserti SQUARIV | SQUARIV rivet nuts



SQF

Acciaio - Fusto quadrato aperto - Testa tonda
Steel - Open square shank - Dome head

68

Inserti filettati per materiali soft | Soft material rivet nuts

Inserti JACKRIV | JACKRIV rivet nuts



JKF

Acciaio - Fusto cilindrico aperto - Testa tonda
Steel - Open cylindrical shank - Dome head

69



JKI/A4

Acciaio inox Aisi 316 - Fusto cilindrico aperto - Testa tonda
Aisi 316 stainless steel - Open cylindrical shank - Dome head

70

Inserti tubolari | Tubular rivet nuts

Inserti TUBRIV | TUBRIV rivet nuts



TBF

Acciaio - Fusto cilindrico aperto
Steel - Open cylindrical shank

71

Inserti maschi | Male rivet nuts

Inserti RIVBOLT | RIVBOLT rivet nuts



BFTC

Acciaio - Fusto cilindrico - Testa tonda
Steel - Cylindrical shank - Dome head

72



BFTE

Acciaio - Fusto esagonale - Testa tonda
Steel - Hexagonal shank - Dome head

72



BITC-Z/A2

Acciaio inox A2 - Fusto cilindrico zigrinato - Testa tonda
A2 stainless steel - Knurled cylindrical shank - Dome head

73



BITEP/A2

Acciaio inox A2 - Fusto semiesagonale - Testa tonda
A2 stainless steel - Semi-hexagonal shank - Dome head

73

Inserti distanziali | Spacer rivet nuts

Inserti DISERT | DISERT rivet nuts

Sconto
Discount



FTCD

Acciaio - Fusto cilindrico - Testa tonda distanziale
Steel - Cylindrical shank - Dome spacing head

74



Inserti filettati antivibranti | Anti-chatter rivet nuts

Inserti PRENSERT | PRENSERT rivet nuts



NPTC

Neoprene - Insetto filettato in ottone - Testa tonda
Neoprene - Brass rivet nut - Dome head

75



Inserti filettati in nylon | Nylon rivet nuts

Inserti NYLONSERT | NYLONSERT rivet nuts



NBRC

Nylon - Insetto filettato in alluminio - Testa tonda
Nylon - Aluminium rivet nut - Dome head

76

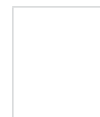

Inserti filettati speciali | Special rivet nuts

Inserti SPECIALI | SPECIAL rivet nuts



Inserti filettati speciali
Special rivet nuts

77

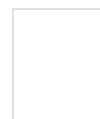

Piastra dimostrativa | Demo plate

Su piastra in lamiera | On metal plate



PIARIV

Assortimento di fissaggi applicati su piastra in lamiera
Assortment of fasteners applied on metal plate

78



Rondelle dimostrative per rivetti ed inserti | Demonstrative washers for blind rivets and rivet nuts

In lamiera zincata nera | Black galvanized sheet



RONDRIV

Per rivetti, inserti, rivetti in cartuccia e perni a saldare
For blind rivets, rivet nuts, speed rivets in cartridge, welding studs





79





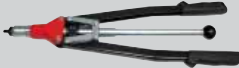

Rivettatrici per inserti | Tools for rivet nuts

Rivettatrici manuali per inserti | Hand tools for rivet nuts

Sconto
Discount

	RIV900	Per inserti da M3 a M5 in alluminio, acciaio e inox, in busta di plastica To place rivet nuts from M3 to M5 in aluminium, steel and stainless steel, supplied in a plastic bag	83	
	RIV901	Per inserti da M3 a M6 in alluminio, acciaio e inox, in busta di plastica To place rivet nuts from M3 to M6 in aluminium, steel and stainless steel, supplied in a plastic bag	83	
	RIV903C	Per inserti da M3 a M10 in alluminio, acciaio e inox, in cassetta To place rivet nuts from M3 to M10 in aluminium, steel and stainless steel, supplied in a box	83	
	RIV98	Per inserti da M3 a M5 in alluminio, acciaio e inox (M6 solo in alluminio e acciaio) To place rivet nuts from M3 to M5 in aluminium, steel and stainless steel (M6 aluminium and steel only)	83	

Rivettatrici manuali per inserti in cassetta | Hand tools for rivet nuts in box

	RIV900C	Con inserti da M3 a M5 in acciaio, in cassetta Supplied with steel rivet nuts from M3 to M5 in a box	84	
	RIV901C	Con inserti da M3 a M6 in acciaio, in cassetta Supplied with steel rivet nuts from M3 to M6 in a box	84	
	RIV901CX	Con inserti da M3 a M6 in acciaio inox, in cassetta Supplied with stainless steel rivet nuts from M3 to M6 in a box	84	
	CASSM	Cassetta in polipropilene trasparente con divisori mobili Transparent polypropylene box with movable dividers	84	

Rivettatrici ad olio manuali per inserti | Hydraulic hand tools for rivet nuts

	RIV905	Per inserti filettati femmine RIVSERT da M3 a M12 e inserti filettati maschi RIVBOLT da M4 a M10 To place RIVSERT female rivet nuts from M3 to M12 and RIVBOLT male rivet nuts, from M4 to M10	85	
---	---------------	---	-----------	--

Rivettatrici manuali a cricchetto per inserti | Ratchet hand tools for rivet nuts

	RIV906	Per inserti filettati femmine RIVSERT da M5 a M12 e inserti filettati maschi RIVBOLT da M5 a M8 To place RIVSERT female rivet nuts from M5 to M12 and RIVBOLT male rivet nuts, from M5 to M18	86	
---	---------------	--	-----------	--

Rivettatrici per inserti | Tools for rivet nuts

Rivettatrici manuali per inserti JACKRIV | Hand tools for JACKRIV rivet nuts

Sconto
Discount

	RIV918	Per inserti JACKRIV da M4, M5, M6, M8 To place M4, M5, M6, M8 JACKRIV rivet nuts	87	
	RIV918C	Con inserti JACKRIV da M4, M5, M6, M8 in acciaio, in cassetta Supplied with M4, M5, M6, M8 steel JACKRIV rivet nuts, in a box	87	
	RIV918CX	Con inserti JACKRIV da M4, M5, M6, M8 in acciaio inox, in cassetta Supplied with M4, M5, M6, M8 stainless steel JACKRIV rivet nuts, in a box	87	

Rivettatrici oleopneumatiche per inserti | Hydropneumatic tools for rivet nuts

	RIV998	Per inserti filettati femmine RIVSERT da M3 a M12 in alluminio e acciaio (inox fino a M10) e inserti filettati maschi RIVBOLT da M4 a M8 To place RIVSERT female rivet nuts in aluminium and steel from M3 to M12 (stainless steel up to M10) and RIVBOLT male rivet nuts, from M4 to M8	88	
	RIV912	Per inserti filettati femmine RIVSERT da M3 a M12 e inserti filettati maschi RIVBOLT da M4 a M10 To place RIVSERT female rivet nuts from M3 to M12 and RIVBOLT male rivet nuts, from M4 to M10	89	
	RIV912CP	Con pedaliera per inserti filettati femmine RIVSERT da M3 a M12 e inserti filettati maschi RIVBOLT da M4 a M10 With pedal for RIVSERT female rivet nuts from M3 to M12 and RIVBOLT male rivet nuts, from M4 to M10	90	
	RIV938	Per inserti filettati femmine RIVSERT da M3 a M10 e inserti filettati maschi RIVBOLT da M4 a M10 To place RIVSERT female rivet nuts from M3 to M10 and RIVBOLT male rivet nuts, from M4 to M10	91	
	RIV938CP	Con pedaliera per inserti filettati femmine RIVSERT da M3 a M10 e inserti filettati maschi RIVBOLT da M4 a M10 With pedal for RIVSERT female rivet nuts from M3 to M10 and RIVBOLT male rivet nuts, from M4 to M10	92	
	RIV938S	Per inserti filettati da M3 a M6, utilizzando la regolazione dell'olio (forza) To place rivet nuts from M3 to M6, using the adjustment of the oil pressure (force)	93	
	RIV939	Per inserti filettati femmine RIVSERT da M3 a M12 e inserti filettati maschi RIVBOLT da M4 a M10 To place RIVSERT female rivet nuts from M3 to M12 and RIVBOLT male rivet nuts, from M4 to M10	94	
	RIV941	Per inserti filettati femmine RIVSERT da M3 a M10 e inserti filettati maschi RIVBOLT da M4 a M10 To place RIVSERT female rivet nuts from M3 to M10 and RIVBOLT male rivet nut, from M4 to M10	95	



Rivettatrici per inserti | Tools for rivet nuts

Rivettatrici oleopneumatiche per inserti | Hydropneumatic tools for rivet nuts

Sconto
Discount

	RIV942	Per inserti filettati femmine RIVSERT da M4 a M12 e inserti filettati maschi RIVBOLT da M4 a M10 To place RIVSERT female rivet nuts from M4 to M12 and RIVBOLT male rivet nuts from M4 to M10	96	
	RIV949	Per inserti filettati femmine RIVSERT da M3 a M12 e inserti filettati maschi RIVBOLT da M4 a M10 To place RIVSERT female rivet nuts from M3 to M12 and RIVBOLT male rivet nuts, from M4 to M10	97	
	RIV916	Per inserti TUBRIV e JACKRIV da M4 a M10 To place TUBRIV and JACKRIV rivet nuts from M4 to M10	98	
	RIV916B	Per inserti RIVSERT da M8 a M20 To place RIVSERT rivet nuts from M8 to M20	99	
	RIV990	Per inserti esagonali RIVSERT da M4 a M10 To place hexagonal RIVSERT rivet nuts from M4 to M10	100	
	RIV991	Per inserti esagonali RIVSERT a M5 a M12 To place hexagonal RIVSERT rivet nuts from M5 to M12	101	

Rivettatrici aria a pistola per inserti | Air gun tool for rivet nuts

	RIV806	Per inserti da M3 a M5 (M6 solo alluminio) To place rivet nuts from M3 to M5 (M6 aluminium only)	102	
	RIV810	Per inserti da M6 a M10 To place rivet nuts from M6 to M10	102	

Rivettatrici a batteria per inserti | Battery tools for rivet nuts

	RIV790	Per inserti da M3 a M8 (M10 solo in alluminio) To place rivet nuts from M3 to M8 (M10 for aluminium only)	103	
---	---------------	--	------------	--

Sistemi automatici | Automatic system

Rivettatrici automatiche per inserti | Automatic feeding tools for rivet nuts

Sconto
Discount



RIV616

Per inserti da M3 a M8
To place rivet nuts from M3 to M8

104

Sistemi di controllo | Control systems

Per posa inserti con rivettatrice | For placing rivet nuts with tool



**CONTROL
RIV**

Modello Basic (RIV938CB, RIV939CB, RIV949CB)
Basic Model (RIV938CB, RIV939CB, RIV949CB)

105



**CONTROL
RIV**

Modello Wireless (RIV938CW, RIV939CW, RIV949CW)
Wireless Model (RIV938CW, RIV939CW, RIV949CW)

105

Testate e moduli | Heads and modules

Moduli per sistema multitesta | Modules for multi head system



RIV600

Banco multitesta per rivettatura
Multi head riveting system

107



RIV603

Modulo per inserti da M3 a M12
Module for rivet nuts from M3 to M12

108

Testine prolungate | Extended heads

Per inserti RIVSERT | For RIVSERT rivet nuts



Testine prolungate per RIVSERT
Extended heads for RIVSERT

109

Bilanciatori | Balancers

A molla | Spring



**RSL
RSP**

Bilanciatori a molla
Spring balancers

110

Tabella per la scelta dell'attrezzo | Guide to the most appropriate installation tool

Tabella riassuntiva per facilitare la scelta dell'attrezzo
Summary table which helps to choose the most appropriate installation tool

111



INFORMAZIONI GENERALI

GENERAL INFORMATION

Come ordinare

How to order







Indicare il codice breve e la descrizione composta da sigla, passo dell'inserto (d) e spessore serrabile (SS).
Always state the item code and the description including abbreviation, rivet nut pitch (d) and grip range (SS).

Esempio:
Example:

Codice	Tipo	Passo inserto (d)	Spessore serrabile (SS)
Item code	Model	Rivet nut pitch (d)	Grip range (SS)
0299400	FTCM03009	M3	0.5 ÷ 2.0

Legenda

Legend

d	Passo dell'inserto Rivet nut pitch	L₂	Lunghezza del fusto dopo l'applicazione Fused length		Quantità per confezione industriale Quantity in each bulk package
	Diametro di foratura Hole diameter	Tipo Model	Sigla del prodotto Product model		Box blister Blister box
T	Larghezza della testa Head width	Codice Item code	Codice del prodotto Product item code		Sacchetto blister Blister pouch
k	Spessore della testa Head thickness		Carico di rottura a trazione in Kg (N) Tensile strength, kgs (N)	€	Prezzo di listino Price list
SS	Spessore serrabile Grip range		Forza max serraggio in Kgm (Nm) Max clamping force Kgm (Nm)		
L	Lunghezza dell'inserto Rivet nut length		Quantità per confezione rivendita e tipo di scatola Quantity in each retail box and model of box		

Confezioni

Packaging

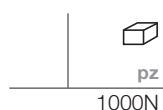

La lettera a fianco della quantità "imballo minimo" indica il tipo di confezione (vedi sotto).
The letter near the quantity "minimal packaging" indicates the kind of the packaging (see below).

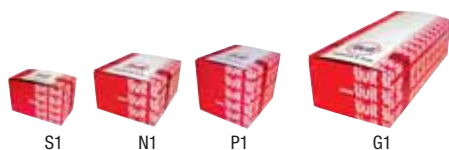

Precisazioni

Specifications

I disegni sono indicativi rispetto alle informazioni e illustrano l'impiego dei prodotti.
I valori inseriti nelle tabelle tecniche possono essere soggetti a modifiche, per i dati aggiornati consultare il portale.
I colori relativi ai prodotti e alle loro applicazioni sono approssimativi e possono non corrispondere alle tonalità dei prodotti.
Rivit si riserva la possibilità di cambiare, modificare o eliminare prodotti da questo catalogo senza preavviso.
The pictures are connected to the information texts and they explain the use of the products.
The data in the technical tables are subject to changes, for up to date data refer to the website.
The colours of the illustrated products are similar to the real ones, therefore they could not correspond perfectly.
Rivit can change or remove products from this catalogue without any notice.



INFORMAZIONI GENERALI

GENERAL INFORMATION

Come si legge la sigla dell'inserto

How to read the rivet nut abbreviation

La sigla è composta da:
The abbreviation is made up of:

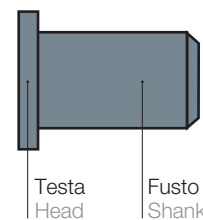

Legenda

Legend



- | | | |
|--|---------------------------------|--|
| A Alluminio
Aluminium | T Tonda
Dome | C Cilindrico
Cylindrical |
| F Acciaio
Steel | S Svasata
Countersunk | C-Z Cilindrico zigrinato
Knurled cylindrical |
| I Acciaio inox
Stainless steel | R Ridotta
Reduced | E Esagonale
Hexagonal |
| O Ottone
Brass | | E-P Semiesagonale
Semi-hexagonal |

Tabella fori

Table of holes



Passo Pitch	Fusto cilindrico Cylindrical shank	Fusto esagonale Hexagonal shank
	Foro (+0.1/-0) Hole (+0.1/-0)e	Esagono Hexagon
M3	5	5
M4	6	6
M5	7	7
M6	9	9
M8	11	11
M10	12	12
M10	13	13
M12	15	-
M12	16	16

Filettatura metrica ISO 6H.
Metric thread ISO 6H

Legenda colori materiale

List of material colours

Alluminio Aluminium	Ottone Brass	Acciaio inox A4 (Aisi 316) A4 stainless steel (Aisi 316)
Acciaio Steel	Acciaio inox A2 (Aisi 304) A2 stainless steel (Aisi 304)	

QR Code



Il simbolo del QR CODE segnala la presenza di contenuti extra, che si possono visualizzare con smartphone o tablet. Se si è in possesso dell'apposita applicazione, puntare la fotocamera del tablet o dello smartphone in modo da inquadrare il QR CODE. Immediatamente verrà riconosciuto dall'applicazione che aprirà il video del prodotto.
The symbol of the QR CODE indicates the presence of extra content that can be viewed with a smartphone or tablet. If you have the application, point the camera of the tablet or smartphone to frame the QR CODE. This will be immediately recognized by the application and the video of the product will start.



INFORMAZIONI GENERALI

GENERAL INFORMATION

Vantaggi dell'inserto filettato

Advantages offered by rivet nuts

Gli inserti filettati permettono di creare filettature su lamiere preforate non accessibili posteriormente. Il loro uso non provoca danni né deformazioni sui materiali trattati superficialmente. Realizzati in acciaio zincato, inox, alluminio, ottone; a testa tonda, svasata, ridotta e nelle misure da M3 a M16. Sono disponibili a fusto cilindrico, semiesagonale, esagono totale, aperti e stagni.

Threaded rivet nut is a fastener that allows making of threads on pre-holed plates, having no access from back blind side. Its use does not cause damages or deformations of superficially coated materials.

Made of steel, stainless steel, aluminium or brass, rivet nuts can have dome, countersunk or reduced head, and are available from M3 to M16.

They can be cylindrical, semi-hexagonal or hexagonal, open or closed end.

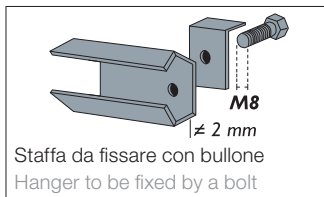

Staffa da fissare con bullone
Hanger to be fixed by a bolt

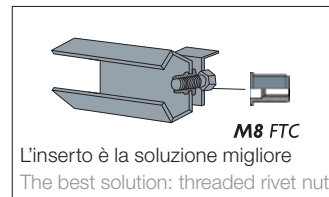

L'inserto è la soluzione migliore
The best solution: threaded rivet nut



Il fissaggio con metodo tradizionale non è sufficiente
Fastening by traditional system: inadequate



Il fissaggio con dado a saldare è costoso
Fastening by welded nut: is expensive!

Applicazione

Application

- 1 Avvitare l'inserto sul tirante della rivettatrice.
 - 2 Introdurre l'inserto nell'alloggiamento del supporto. La tolleranza massima è di 0,1 mm.
 - 3 Il tirante sviluppa una forza di trazione in modo che il fusto si comprime deformandosi sotto il supporto.
 - 4 Svitare il tirante dell'inserto ormai applicato.
 - 5 L'inserto è pronto, si possono avvitare ora gli appositi elementi di fissaggio.
- 1 Screw the rivet nut on the tie rod of the tool.
 - 2 Put the rivet nut inside the hole. Maximum tolerance is 0.1 mm.
 - 3 The tensile stress developed by the tie rod, compresses and deforms the bottom part of the rivet nut against the working piece.
 - 4 Unscrew the tie rod from the installed rivet nut.
 - 5 Rivet nut is now ready, you can screw the suitable fixing elements.

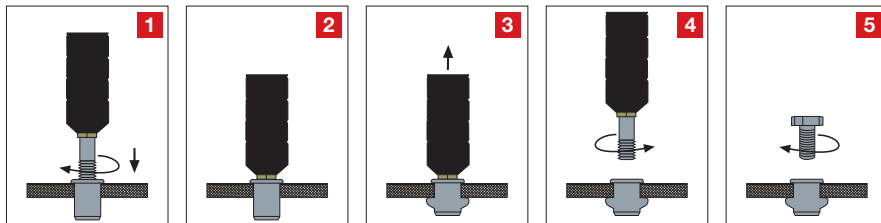

Campi di utilizzo

Fields of application

- 1 Maschiatura resistente a carichi importanti e all'usura, utilizzazione su lamiere sottili.
 - 2 Rivettatura di vari elementi con inoltre possibilità di avvitare un elemento riportato.
 - 3 Assemblaggio a tenuta stagna contro i liquidi utilizzando RIVSERT chiusi.
 - 4 Maschiatura alla "cieca" di profili e superfici accessibili da un lato solo.
 - 5 Fissaggio di elementi di costruzione con funzione di distanziale.
- 1 Tapping resistant to heavy loads and wear, to use on thin sheet metal.
 - 2 Riveting of various elements with the possibility of screwing a back element.
 - 3 Sealed assembly against liquids using closed RIVSERT.
 - 4 "Blind" tapping of profiles and surfaces accessible from one side only.
 - 5 Fixing of building elements with the function of spacers.

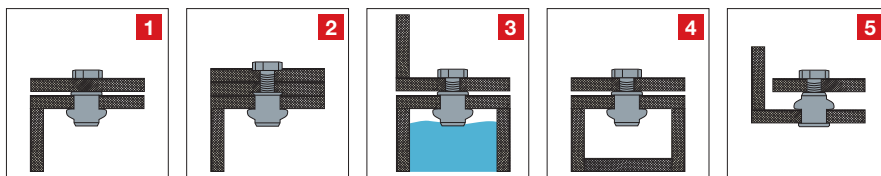

ETICHETTA PRODOTTI PRODUCT LABEL



NB. In caso di difetto del prodotto comunicare a Rivot lotto e codice articolo.
NB. In case of product defect please communicate to Rivot production lot and article number.



Legenda del codice a barre Legend of the barcode

L'insieme delle cifre che compongono il codice sono successivamente riservate:

- I primi 2 numeri identificano la nazione.
- I successivi 5 numeri identificano il proprietario del marchio.
- I 5 numeri seguenti identificano il codice del prodotto.
- L'ultimo numero identifica la cifra di controllo.

The numbers in the barcode are so divided:

- The first 2 digits identify the country.
- The following 5 digits identify the brand owner.
- The next 5 digits identify the product item code.
- The last digit is a control number.

Il codice a barre utilizzato "EAN13" è il sistema di numerazione per identificare i prodotti nelle transazioni commerciali tra aziende. Ha una validità internazionale e contraddistingue uno ed un solo prodotto. Questo significa che ogni prodotto viene identificato da un solo codice e ad ogni codice corrisponde un solo prodotto in tutto il mondo.

EAN 13 barcode is used to identify products in commercial transactions among companies. It is internationally accepted and it identifies one single product, that means that each product corresponds to one single item code and each item code corresponds to one single product all over the world.



IMBALLAGGIO PACKAGING

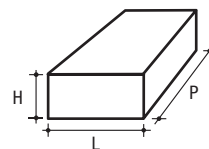

Confezioni rivendita Retail packages

Tipo di scatola Type of box	L	P	H	Descrizione Type of box	Codice Item code
S1	68	118	75	Supermignon Extra-extra small	3516400
N1	118	136	75	Mignon Extra small	3516000
P1	118	136	113	Piccola Small	3516100
G1	118	272	75	Grande Large	3516300
L1	236	272	113	Extra large	3516200



Confezioni industriali Bulk boxes

Tipo di scatola Type of box	L	P	H	Uso Usage	Codice Item code
01	245	295	155	Per merce sfusa For bulk goods	3583100



Confezioni per imballaggio Packages

Tipo di scatola Type of box	L	P	H	Uso Usage	Codice Item code
01	245	295	155	Per merce sfusa For bulk goods Per 12 scatole S1 Contains 12 boxes S1 Per 6 scatole N1 Contains 6 boxes N1 Per 4 scatole P1 Contains 4 boxes P1 Per 3 scatole G1 Contains 3 boxes G1	3583100
21	295	263	250	Per 24 scatole S1 Contains 24 boxes S1 Per 12 scatole N1 Contains 12 boxes N1 Per 8 scatole P1 Contains 3 boxes P1 Per 6 scatole G1 Contains 6 boxes G1 Per 2 scatole L1 Contains 2 boxes L1 Per 2 scatole B1 Contains 2 boxes B1	3519400
31	383	295	250	Per 36 scatole S1 Contains 36 boxes S1 Per 18 scatole N1 Contains 18 boxes N1 Per 12 scatole P1 Contains 12 boxes P1 Per 9 scatole G1 Contains 9 boxes G1 Per 3 scatole L1 Contains 3 boxes L1 Per 3 scatole B1 Contains 3 boxes B1	3519500
B1	280	215	110	Per sacchetti blister For blisters	1955400
51	510	140	205	Per utensili Rivit For Rivit tools	4274400
05	510	140	410	Per utensili Rivit For Rivit tools	3129600
CARTONPALLET	1050	760	550	Per spedizioni voluminose For voluminous shipments	2771800



Tipo pedane Pallet

Tipo di pallet Type of pallet	L	P	Uso Usage	Codice Item code
EU	800	1200	Pallet EUR EUR pallet	2551700
P2	800	600	Pallet a perdere Non-returnable pallet	2779200
P1	800	1200	Pallet a perdere Non-returnable pallet	2446500
K2	800	600	EUR sterilizzato palsimeur Fumigated EUR pallet	3745100
K1	800	1200	EUR sterilizzato palsimeur Fumigated EUR pallet	3124700

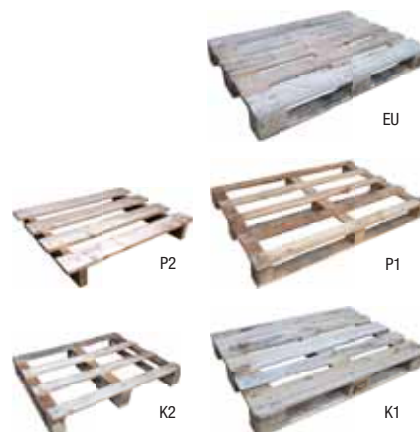

Inserti filettati RIVSERT

RIVSERT rivet nuts

FTC

34000

■ Acciaio

Steel



Fusto cilindrico aperto

Open cylindrical shank

Testa tonda

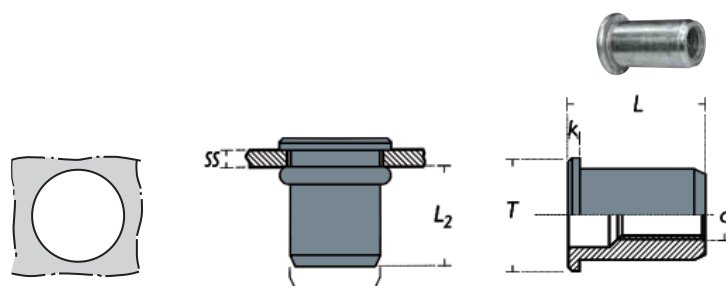
Dome head





d		T	k	SS	L	L ₂	Tipo	Codice		
mm	mm	mm	max	mm	mm	min ÷ max	Model	Item code	pz	pz
M3	5.0	7.0	0.8	0.5 ÷ 1.5	8.5	4.2 ÷ 4.6	FTC0301505	0299400	1000S	20000
				1.5 ÷ 2.5	10.5		FTC0302505	1758100	1000S	20000
M4	6.0	9.0	1.0	0.5 ÷ 2.0	10.5	5.5 ÷ 6.0	FTC0402006	0299900	1000N	10000
				2.0 ÷ 3.5	12.0		FTC0403506	0300200	1000N	10000
M5	7.0	10.0	1.2	0.5 ÷ 2.5	13.0	7.2 ÷ 7.7	FTC0502507	0300500	500N	8000
				3.0 ÷ 5.0	17.0		FTC0505007	0300700	500N	8000
				5.5 ÷ 8.0	21.0		FTC0508007	0300800	500N	8000
M6	9.0	12.0	1.5	0.5 ÷ 3.0	15.5	7.6 ÷ 8.2	FTC0603009	0300900	500N	4000
				3.0 ÷ 5.5	18.0		FTC0605509	0301100	500P	3000
M8	11.0	15.0	1.5	0.5 ÷ 3.5	18.5	9.5 ÷ 10.1	FTC0803511	2270000	250N	2500
				3.5 ÷ 6.0	21.0		FTC0806011	2270100	250N	2000
				6.0 ÷ 9.0	23.0		FTC0809011	0302000	250N	2000
M10	12.0	16.0	1.7	1.0 ÷ 3.0	19.0	10.7 ÷ 11.5	FTC1003012	0072100	200N	1500
				3.5 ÷ 6.0	22.0		FTC1006012	2645400	100N	1000
M10	13.0	17.0	1.7	1.0 ÷ 3.5	21.0	12.5 ÷ 13.5	FTC1003513	0308000	100N	1500
				3.5 ÷ 6.0	24.0		FTC1006013	0302300	100N	1000
M12	15.0	18.0	2.0	1.0 ÷ 4.0	22.0	13.3 ÷ 14.5	FTC1204015	1608800	100N	800
M12	16.0	22.0	2.0	1.0 ÷ 4.0	25.0	18.2 ÷ 19.0	FTC1204016	0302800	100N	800
				3.5 ÷ 6.5	29.0		FTC1206516	1529500	50N	500
M16	21.0	26.0	2.5	2.0 ÷ 7.0	33.0	21.0 ÷ 21.5	FTC1607021	4155500	50P	400



Applicazione
Application



d			Kg	N	Kgm	Nm
mm	mm	mm				
M3		5.0	430	4300	0.1	1
M4		6.0	740	7300	0.4	4
M5		7.0	1160	11450	0.7	7
M6		9.0	1720	16900	1.5	15
M8		11.0	2460	24200	2.6	26
M10		12.0	2920	28650	4.5	45
M10		13.0	3160	31000	4.5	45
M12		15.0	3640	35700	7.0	70
M12		16.0	4840	47500	7.6	76
M16		21.0	7650	75000	18.0	180

Inserti filettati RIVSERT

RIVSERT rivet nuts

FRC

34020

■ Acciaio

Steel



Fusto cilindrico aperto

Open cylindrical shank

Testa ridotta

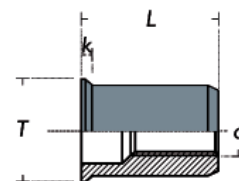
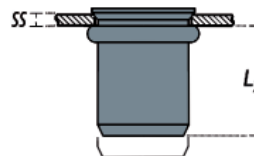
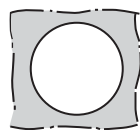
Reduced head





d		T	k	SS	L	L ₂	Tipo	Codice		
mm	mm	mm	max	mm	mm	min ÷ max	Model	Item code	pz	pz
M3	5.0	5.5	0.5	0.5 ÷ 2.0	9.0	5.5 ÷ 6.5	FRC0302005	0306100	1000S	20000
M4	6.0	7.0	0.5	0.5 ÷ 2.0	10.5	6.5 ÷ 7.0	FRC0402006	0306500	1000N	16000
				2.0 ÷ 4.0	13.0		FRC0404060	0306700	1000N	13000
M5	7.0	8.0	0.5	0.5 ÷ 2.0	12.0	7.5 ÷ 8.0	FRC0502007	0306800	1000N	10000
				2.0 ÷ 4.0	13.0		FRC0504007	0307100	500N	8000
M6	9.0	10.0	0.6	0.5 ÷ 2.5	14.0	8.5 ÷ 9.5	FRC0602509	0307200	500N	5000
				2.5 ÷ 5.0	17.0		FRC0605009	0307500	500N	4000
M8	11.0	12.0	0.6	1.0 ÷ 3.0	16.5	10.0 ÷ 11.5	FRC0803011	0307600	250N	3000
				3.0 ÷ 5.0	18.5		FRC0805011	0307900	250N	2500
M10	12.0	13.5	0.7	1.0 ÷ 3.0	18.0	12.0 ÷ 13.0	FRC1003012	3245200	200N	1500
				2.5 ÷ 4.0	19.5		FRC1004012	0308100	200N	1500
M10	13.0	14.0	0.7	1.0 ÷ 3.0	21.0	12.0 ÷ 13.0	FRC1003013	0071900	200N	1500
				3.0 ÷ 6.0	22.5		FRC1006013	0071800	200N	1500
M12	15.0	17.0	0.7	1.0 ÷ 3.5	21.5	13.5 ÷ 14.5	FRC1203515	0308200	100N	1000
				3.0 ÷ 6.5	24.0		FRC1206515	1609600	100N	800

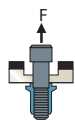

Applicazione

Application



d			Kg	N	Kgm	Nm
mm	mm	mm				
M3	5.0	5.0	430	4300	0.1	1
M4	6.0	6.0	740	7300	0.4	4
M5	7.0	7.0	1160	11450	0.7	7
M6	9.0	9.0	1720	16900	1.5	15
M8	11.0	11.0	2460	24200	2.6	26
M10	12.0	12.0	2920	28650	4.5	45
M10	13.0	13.0	3160	31000	4.5	45
M12	15.0	15.0	3640	35700	7.0	70

Inserti filettati RIVSERT - foro in pollici

RIVSERT rivet nuts - inch hole

FRC-P

34029

■ Acciaio

Steel

Fusto cilindrico aperto

Open cylindrical shank

Testa ridotta

Reduced head

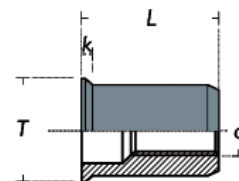
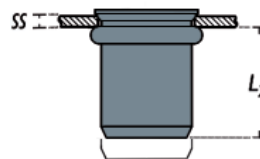
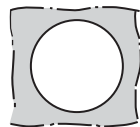

d		T	k	SS	L	L ₂	Tipo	Codice		
mm	mm	mm	max	mm	mm	min ÷ max	Model	Item code	pz	pz
M3	3/16 - 4.8	5.3	0.3	0.5 ÷ 1.5	9.0	5.2 ÷ 5.6	FRCP0301505	0306000	1000S	20000
M4	1/4 - 6.4	6.9	0.5	0.5 ÷ 2.0	10.5	6.3 ÷ 6.7	FRCP0402006	0306400	500S	16000
M5	9/32 - 7.2	7.7	0.5	0.5 ÷ 3.0	12.0	7.4 ÷ 7.8	FRCP0503007	0307000	500S	10000
M6	3/8 - 9.6	10.2	0.5	0.5 ÷ 3.0	14.0	8.8 ÷ 9.6	FRCP0603010	0307300	250S	5000
M8	27/64 - 10.6	11.3	0.5	0.5 ÷ 3.0	16.0	10 ÷ 10.8	FRCP0803011	0307800	250N	3000

NB: Filetto metrico - Diametro esterno in pollici.

NB: Metric thread - Outer diameter in inches.



Applicazione
Application

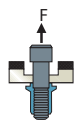

d			Kg	N	Kgm	Nm
mm	mm	mm				
M3		4.8	380	3720	0.15	1.5
M4		6.4	630	6160	0.7	7
M5		7.2	1270	12450	1.4	14
M6		9.6	2330	22830	2.2	22
M8		10.6	3250	31850	3.2	32

Inserti filettati RIVSERT

RIVSERT rivet nuts

FSC

34010

■ Acciaio

Steel



Fusto cilindrico aperto

Open cylindrical shank

Testa svasata

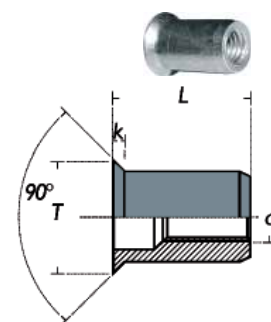
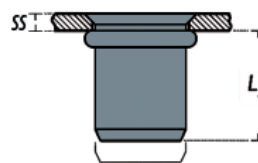
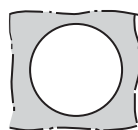
Countersunk head





d		T	k	SS	L	L ₂	Tipo	Codice		
mm	mm	mm	max	mm	mm	min ÷ max	Model	Item code	pz	pz
M3	5.0	8.0	1.5	1.5 ÷ 3.0	9.5	4.5 ÷ 5.5	FSC0303005	0303100	1000S	20000
M4	6.0	9.0	1.5	1.5 ÷ 3.0	12.0	6.0 ÷ 6.5	FSC0403506	0303400	1000N	10000
				3.0 ÷ 5.0	13.0		FSC0405006	0303600	1000N	10000
M5	7.0	10.0	1.5	1.5 ÷ 4.0	13.0	6.5 ÷ 7.5	FSC0504007	0304000	1000N	8000
				4.0 ÷ 6.0	16.0		FSC0506007	0304100	500N	7000
M6	9.0	12.0	1.5	1.5 ÷ 4.0	15.5	8.5 ÷ 9.5	FSC0604009	0304400	500N	4000
				4.0 ÷ 6.0	18.0		FSC0606009	0304600	500P	3000
M8	11.0	14.0	1.5	1.5 ÷ 4.5	18.5	9.5 ÷ 11	FSC0804511	0304900	250N	2500
				4.0 ÷ 6.0	19.0		FSC0806011	0305100	250N	2000
				6.5 ÷ 9.0	24.0		FSC0809011	0305200	200N	2000
M10	12.0	15.0	1.5	1.5 ÷ 4.0	19.0	11.0 ÷ 13.0	FSC1004012	3567900	200N	2000
M10	13.0	15.5	1.5	1.5 ÷ 4.0	21.0	11.0 ÷ 13.0	FSC1004013	0305400	200N	2000
				4.0 ÷ 6.5	25.0		FSC1006513	0305600	100N	1200
				6.5 ÷ 9.0	28.0		FSC1009013	0305700	100N	1000
M12	16.0	19.0	1.8	1.7 ÷ 4.5	26.0	16.5 ÷ 17.5	FSC1204516	1556700	100P	800
				4.0 ÷ 7.5	29.0		FSC1207516	1610100	100P	800
				7.0 ÷ 10.5	32.0		FSC1210516	1610200	50N	600

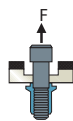

Applicazione
Application



d			Kg	N	Kgm	Nm
mm	mm	mm				
M3		5.0	430	4300	0.1	1
M4		6.0	740	7300	0.4	4
M5		7.0	1160	11450	0.7	7
M6		9.0	1720	16900	1.5	15
M8		11.0	2460	24200	2.6	26
M10		12.0	2920	28650	4.5	45
M10		13.0	3160	31000	4.5	45
M12		15.0	3640	35700	7.0	70
M12		16.0	3640	35700	7.0	70

Inserti filettati RIVSERT zigrinati

RIVSERT knurled rivet nuts

FTC-Z

34002

■ Acciaio

Steel

Fusto cilindrico zigrinato aperto

Open knurled cylindrical shank

Testa tonda

Dome head

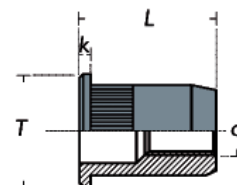
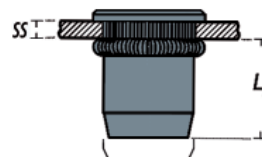
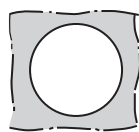

d		T	k	SS	L	L ₂	Tipo	Codice		
mm	mm	mm	max	mm	mm	min ÷ max	Model	Item code	pz	pz
M3	5.0	8.0	0.8	0.5 ÷ 1.5	10.0	4.2 ÷ 4.6	FTCZ0301505	3579500	1000S	20000
M4	6.0	9.0	1.0	0.5 ÷ 2.0	10.5	5.5 ÷ 6.0	FTCZ0402006	2750500	1000N	10000
				2.0 ÷ 3.5	12.0		FTCZ0403506	2690600	1000N	10000
				3.0 ÷ 5.5	14.0		FTCZ0405506	5126800	500N	4500
M5	7.0	10.0	1.2	0.5 ÷ 3.0	13.0	7.2 ÷ 7.7	FTCZ0502507	2194100	500N	8000
				2.5 ÷ 5.0	16.5		FTCZ0505007	2806800	500N	8000
M6	9.0	12.0	1.5	0.5 ÷ 3.0	15.5	7.6 ÷ 8.2	FTCZ0603009	2194200	500N	4000
				3.0 ÷ 5.5	19.5		FTCZ0605509	3329900	500P	3000
				6.0 ÷ 9.0	23.0		FTCZ0809011	4350600	200N	1500
M8	11.0	15.0	1.5	1.0 ÷ 3.5	19.0	10.7 ÷ 11.9	FTCZ1003512	2698000	200N	1500
				3.5 ÷ 6.0	23.0		FTCZ1006012	3747700	100N	1000
				1.0 ÷ 3.5	21.5	12.5 ÷ 13.5	FTCZ1003513	3009100	100N	1500
M10	12.0	16.0	1.7	3.5 ÷ 6.0	24.0		FTCZ1006013	3328000	100N	1000
				1.0 ÷ 3.5	25.0	14.5 ÷ 15.5	FTCZ1204016	3502700	100N	600
				4.0 ÷ 7.0	28.0		FTCZ1207016	4217400	50N	500



Applicazione
Application

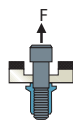

d			Kg	N	Kgm	Nm
mm	mm	mm				
M3		5.0	430	4300	0.1	1
M4		6.0	740	7300	0.4	4
M5		7.0	1160	11450	0.7	7
M6		9.0	1720	16900	1.5	15
M8		11.0	2460	24200	2.6	26
M10		12.0	2920	28650	4.5	45
M10		13.0	3160	31000	4.5	45
M12		16.0	4840	47500	7.6	76

Inserti filettati RIVSERT zigrinati

RIVSERT knurled rivet nuts

FRC-Z

34022

■ Acciaio

Steel



Fusto cilindrico zigrinato aperto

Open knurled cylindrical shank

Testa ridotta

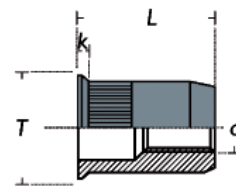
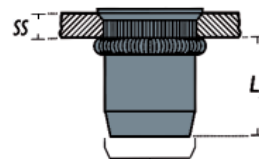
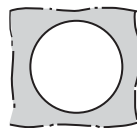
Reduced head





d		T	k	SS	L	L ₂	Tipo	Codice		
mm	mm	mm	max	mm	mm	min ÷ max	Model	Item code	pz	pz
M3	5.0	5.5	0.3	0.5 ÷ 2.0	9.0	5.5 ÷ 6.5	FRCZ0302005	3394700	1000S	20000
				2.0 ÷ 3.5	11.5	FRCZ0303505	0321000	1000S	20000	
M4	6.0	7.0	0.5	0.5 ÷ 2.0	11.0	6.5 ÷ 7.0	FRCZ0402006	2673800	1000N	16000
				2.0 ÷ 4.0	13.0	FRCZ0404006	3498900	1000N	13000	
M5	7.0	8.0	0.5	0.5 ÷ 3.0	11.5	7.5 ÷ 8.0	FRCZ0503007	2232600	1000N	10000
				1.5 ÷ 3.5	13.0	FRCZ0503507	4300000	1000N	10000	
				2.5 ÷ 5.0	15.0	FRCZ0505007	3466700	500N	8000	
M6	9.0	10.0	0.5	0.5 ÷ 3.0	14.0	8.5 ÷ 9.5	FRCZ0603009	1962000	500N	5000
				3.0 ÷ 5.0	17.5	FRCZ0605009	3348400	500N	4000	
M8	11.0	12.0	0.5	0.5 ÷ 3.0	16.5	10.0 ÷ 11.5	FRCZ0803011	1831600	250N	3000
				3.0 ÷ 5.0	18.5	FRCZ0805011	2806900	250N	2500	
M10	12.0	13.3	0.8	0.8 ÷ 3.5	19.5	11.0 ÷ 13.0	FRCZ1003512	4312600	200N	1500
				4.0 ÷ 6.5	24.0	FRCZ1006512	4512900	200N	1500	
M10	13.0	14.0	0.8	1.0 ÷ 3.5	21.0	12.0 ÷ 13.0	FRCZ1003513	3015900	200N	1500
				3.0 ÷ 6.0	22.0	FRCZ1006013	3348500	200N	1500	
M12	16.0	18.0	1.0	1.0 ÷ 4.0	24.0	13.5 ÷ 14.3	FRCZ1204016	3751300	100N	1000

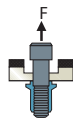

Applicazione
Application



d			Kg	N	Kgm	Nm
mm	mm	mm				
M3	5.0	5.0	430	4300	0.1	1
M4	6.0	6.0	740	7300	0.4	4
M5	7.0	7.0	1160	11450	0.7	7
M6	9.0	9.0	1720	16900	1.5	15
M8	11.0	11.0	2460	24200	2.6	26
M10	13.0	13.0	3160	31000	4.5	45
M12	15.0	15.0	3640	35700	7.0	70

Inserti filettati RIVSERT zigrinati

RIVSERT knurled rivet nuts

FSC-Z

34012

■ Acciaio

Steel

Fusto cilindrico zigrinato aperto

Open knurled cylindrical shank

Testa svasata

Countersunk head

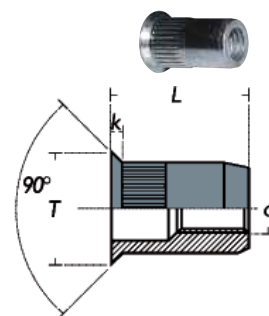
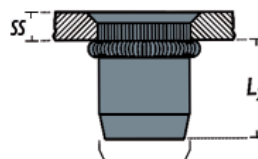
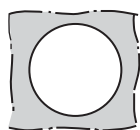

d		T	k	SS	L	L ₂	Tipo	Codice		
mm	mm	mm	max	mm	mm	min ÷ max	Model	Item code	pz	pz
M3	5.0	8.0	1.5	3.0 ÷ 4.0	12.5	4.5 ÷ 5.5	FSCZ0304005	3502600	1000S	20000
M4	6.0	9.0	1.5	1.5 ÷ 3.0	12.0	6.0 ÷ 6.5	FSCZ0403006	3492800	1000N	10000
M5	7.0	10.0	1.5	1.5 ÷ 3.5	13.0	6.5 ÷ 7.5	FSCZ0503507	3115900	1000N	8000
				3.5 ÷ 6.0	15.0		FSCZ0506007	3776800	500N	7000
				4.0 ÷ 7.0	16.5		FSCZ0507007	4760700	500N	7000
M6	9.0	12.0	1.5	1.5 ÷ 4.0	15.5	8.5 ÷ 9.5	FSCZ0604009	3020300	500N	4000
				4.0 ÷ 6.5	19.0		FSCZ0605009	3776900	500P	3000
M8	11.0	14.0	1.5	2.0 ÷ 4.5	18.5	9.5 ÷ 11.0	FSCZ0804511	3116000	250N	2500
				5.0 ÷ 7.0	20.0		FSCZ0807011	3348600	200N	2000
M10	13.0	16.0	1.5	2.0 ÷ 5.0	21.0	11.0 ÷ 13.0	FSCZ1005013	3264800	200N	2000
M12	16.0	19.0	1.8	1.7 ÷ 4.5	24.5	16.5 ÷ 17.5	FSCZ1204516	4698800	100P	800
				7.5 ÷ 10.5	31.0		FSCZ1210516	5125700	100P	800



Applicazione

Application

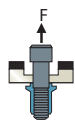

d			Kg	N	Kgm	Nm
mm	mm	mm				
M3	5.0	5.0	430	4300	0.1	1
M4	6.0	6.0	740	7300	0.4	4
M5	7.0	7.0	1160	11450	0.7	7
M6	9.0	9.0	1720	16900	1.5	15
M8	11.0	11.0	2460	24200	2.6	26
M10	13.0	13.0	3160	31000	4.5	45
M12	16.0	16.0	3640	35700	7.0	70

Inserti filettati RIVSERT

RIVSERT rivet nuts

FTEP

34007

■ Acciaio

Steel



Fusto semiesagonale aperto

Open semi-hexagonal shank

Testa tonda

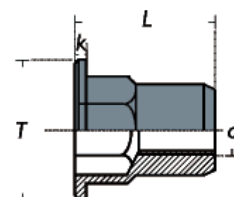
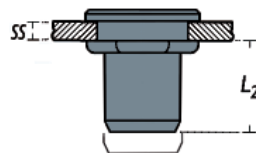
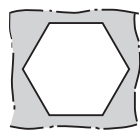
Dome head





d		T	k	SS	L	L ₂	Tipo	Codice		
mm	mm	mm	max	mm	mm	min ÷ max	Model	Item code	pz	pz
M3	5.0	6.0	0.4	0.5 ÷ 2.0	8.8	5.0 ÷ 5.5	FTEP0302005	4793200	1000N	10000
M4	6.0	9.0	0.8	0.5 ÷ 2.0 2.0 ÷ 4.0	11.0	5.5 ÷ 6.5	FTEP0402006	3114600	1000N	10000
M5	7.0	10.0	1.0	0.5 ÷ 3.0	13.0	7.0 ÷ 8.0	FTEP0503007	2413900	500N	8000
M6	9.0	13.0	1.3	0.5 ÷ 3.0	15.0	7.5 ÷ 8.5	FTEP0603009	2414000	500N	4000
M8	11.0	16.0	1.5	0.5 ÷ 3.0 6.0 ÷ 9.0	18.0	10.0 ÷ 11.0	FTEP0803011	2414100	250N	2000
M10	13.0	18.0	1.7	1.0 ÷ 3.5	21.0	11.5 ÷ 12.5	FTEP1003513	3109700	100N	1500
M12	16.0	23.0	2.0	1.0 ÷ 4.0	26.0	15.5 ÷ 17.0	FTEP1204016	1899000	50N	600

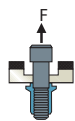

Applicazione
Application



d			Kg	N	Kgm	Nm
mm	mm	mm				
M3		5.0	480	4700	0.1	1
M4		6.0	660	6470	0.4	4
M5		7.0	1140	11180	0.7	7
M6		9.0	1750	17150	1.4	14
M8		11.0	2430	23810	2.4	24
M10		13.0	3480	34100	4.2	42
M12		16.0	5140	50370	7.6	76

Inserti filettati RIVSERT

RIVSERT rivet nuts

FREP

34028

■ Acciaio

Steel



Fusto semiesagonale aperto

Open semi-hexagonal shank

Testa ridotta

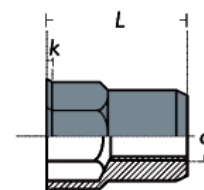
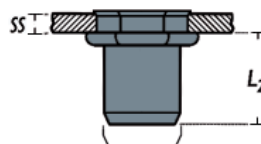
Reduced head





d		T	k	SS	L	L ₂	Tipo	Codice		
mm	mm	mm	max	mm	mm	min ÷ max	Model	Item code	pz	pz
M3	5.0	6.0	0.4	0.3 ÷ 1.5	9.0	5.0 ÷ 5.5	FREP0301505	4074200	1000S	20000
				1.5 ÷ 2.5	10.0	FREP0302505	3383900	1000S	20000	
M4	6.0	7.0	0.5	0.5 ÷ 2.0	12.0	6.5 ÷ 7.5	FREP0402006	2868400	1000N	14000
M5	7.0	8.0	0.5	0.5 ÷ 3.0	13.0	7.0 ÷ 8.0	FREP0503007	1673100	500N	8000
				2.5 ÷ 4.5	13.0	FREP0504507	3751400	500N	8000	
M6	9.0	10.0	0.6	0.5 ÷ 3.0	16.0	8.5 ÷ 9.5	FREP0603009	0867500	500N	4000
				3.0 ÷ 5.5	17.8	FREP0605509	3036800	500P	4000	
M8	11.0	12.0	0.6	0.5 ÷ 3.5	17.5	9.5 ÷ 10.5	FREP0803511	2413800	250N	2500
M10	13.0	14.5	0.7	1.0 ÷ 3.5	21.0	12.0 ÷ 13.0	FREP1003513	3094700	200N	1500
M12	16.0	17.5	1.0	1.0 ÷ 4.0	24.0	16.0 ÷ 18.0	FREP1204016	3590500	100N	1000
				3.5 ÷ 7.5	27.5	FREP1207516	4356900	100N	800	

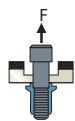

Applicazione

Application



d			Kg	N	Kgm	Nm
mm	mm	mm				
M3		5.0	480	4700	0.1	1
M4		6.0	660	6470	0.4	4
M5		7.0	1140	11180	0.7	7
M6		9.0	1750	17150	1.4	14
M8		11.0	2430	23810	2.4	24
M10		13.0	3480	34100	4.2	42
M12		16.0	6420	62920	7.6	76

Inserti filettati RIVSERT - foro in pollici

RIVSERT rivet nuts - inch hole

FREP-P

34027

■ Acciaio

Steel



Fusto semiesagonale aperto - esagono in pollici

Open semi-hexagonal shank - hexagon in inches

Testa ridotta

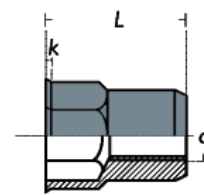
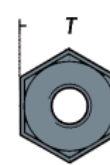
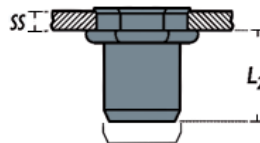
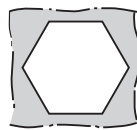
Reduced head





d		T	k	SS	L	L ₂	Tipo	Codice		
mm	mm	mm	max	mm	mm	min ÷ max	Model	Item code	pz	pz
M3	4.8	5.5	0.4	0.5 ÷ 1.5	8.5	5.5 ÷ 5.6	FREPP0301505	2684100	1000S	20000
M4	6.4	7.2	0.5	0.5 ÷ 2.0	10.0	6.5 ÷ 6.8	FREPP0402006	0298800	500S	14000
M5	7.3	8.10	0.5	0.5 ÷ 2.5	12.0	6.5 ÷ 6.7	FREPP0502507	0298900	500N	8000
M6	9.7	10.5	0.6	0.5 ÷ 3.0	15.0	9.4 ÷ 9.8	FREPP0603010	0299000	500N	4000
M8	10.7	11.5	0.6	1.0 ÷ 3.5	16.0	9.5 ÷ 10.0	FREPP0803511	0299100	250N	2500

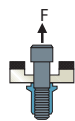

Applicazione

Application



d			Kg	N	Kgm	Nm
mm	mm	mm				
M3	4.8	4.8	480	4700	0.1	1
M4	6.4	6.4	660	6470	0.4	4
M5	7.3	7.3	1140	11180	0.7	7
M6	9.7	9.7	1750	17150	1.4	14
M8	10.7	10.7	2430	23810	2.4	24

Inserti filettati RIVSERT

RIVSERT rivet nuts

FTE

34005

■ Acciaio

Steel



Fusto esagonale aperto

Open hexagonal shank

Testa tonda

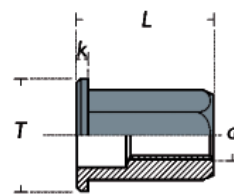
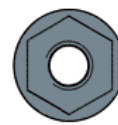
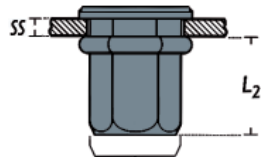
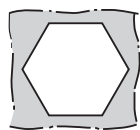
Dome head





d		T	k	SS	L	L ₂	Tipo	Codice		
mm	mm	mm	max	mm	mm	min ÷ max	Model	Item code	pz	pz
M4	6.0	9.0	0.8	0.5 ÷ 2.0	11.0	5.5 ÷ 6.5	FTE0402006	0310700	1000N	10000
				2.0 ÷ 4.0	13.5	FTE0404006	1773800	1000N	10000	
M5	7.0	10.0	1.0	0.5 ÷ 3.0	14.0	7.0 ÷ 8.0	FTE0503007	0310800	500N	8000
				3.0 ÷ 6.0	16.5	FTE0506007	1774000	500N	8000	
M6	9.0	13.0	1.3	0.5 ÷ 3.0	15.0	8.5 ÷ 9.5	FTE0603009	0310900	500N	4000
				3.0 ÷ 5.5	19.5	FTE0605509	1774100	500P	4000	
M8	11.0	16.0	1.5	1.0 ÷ 3.5	18.0	10.5 ÷ 12.5	FTE0803511	0311000	250N	2000
				3.0 ÷ 6.0	21.0	FTE0806011	1774300	200N	2000	
M10	12.0	18.0	1.7	1.0 ÷ 3.5	21.0	12.5 ÷ 13.5	FTE1003512	2970900	100N	1500
				3.5 ÷ 6.0	24.0	FTE1006013	1774400	100N	1000	
M10	13.0	19.0	1.7	1.0 ÷ 3.5	23.0	12.5 ÷ 14.5	FTE1003513	0311100	100N	1500
				3.5 ÷ 6.0	24.0	FTE1006013	1774400	100N	1000	
M12	16.0	23.0	2.0	1.0 ÷ 4.0	27.0	15.0 ÷ 16.0	FTE1204016	4091200	50N	600

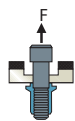

Applicazione

Application



d			Kg	N	Kgm	Nm
mm	mm	mm				
M4	6.0	6.0	680	6660	0.4	4
M5	7.0	7.0	1260	12350	0.7	7
M6	9.0	9.0	1770	17350	1.4	14
M8	11.0	11.0	2560	25090	2.4	24
M10	12.0	12.0	3100	30380	4.0	40
M10	13.0	13.0	4220	41360	4.2	42
M12	15.0	15.0	6420	62920	7.6	76

Inserti filettati RIVSERT

RIVSERT rivet nuts

FRE

34025

■ **Acciaio**

Steel



Fusto esagonale aperto

Open hexagonal shank

Testa ridotta

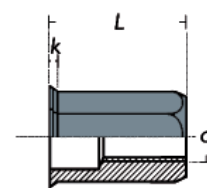
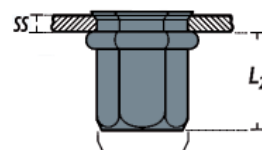
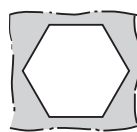
Reduced head





d		T	k	SS	L	L ₂	Tipo	Codice		
mm	mm	mm	max	mm	mm	min ÷ max	Model	Item code	pz	pz
M4	6.0	7.0	0.5	0.5 ÷ 2.0	11.0	6.0 ÷ 7.0	FRE0402006	0311300	1000N	14000
				1.5 ÷ 4.0	13.5	FRE0404006	1769100	1000N	14000	
M5	7.0	8.0	0.5	0.5 ÷ 3.0	14.5	7.5 ÷ 9.0	FRE0503007	0311400	500N	8000
				3.0 ÷ 5.0	16.0	FRE0505007	1769300	500N	8000	
M6	9.0	10.0	0.6	0.5 ÷ 3.0	16.0	9.5 ÷ 10.5	FRE0603009	0311500	500N	4000
				2.5 ÷ 5.5	18.0	FRE0605509	1769400	500P	4000	
M8	11.0	12.0	0.6	0.5 ÷ 3.0	18.0	11.0 ÷ 12.0	FRE0803011	0311600	250N	2500
				3.0 ÷ 6.0	20.0	FRE0806011	1769600	200N	2000	
M10	12.0	13.1	0.7	1.0 ÷ 3.5	19.0	14.5 ÷ 16.5	FRE1003512	4484600	200N	1500
M10	13.0	14.5	0.7	1.0 ÷ 3.5	21.0		FRE1003513	1769700	200N	1500
M12	16.0	18.0	1.0	3.0 ÷ 6.0	23.5		FRE1006013	1769800	100N	1000
				1.0 ÷ 4.0	25.0	17.0 ÷ 18.5	FRE1204016	4280000	100N	1000

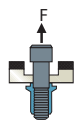

Applicazione

Application



d			Kg	N	Kgm	Nm
mm	mm	mm				
M4		6.0	680	6660	0.4	4
M5		7.0	1260	12350	0.7	7
M6		9.0	1770	17350	1.4	14
M8		11.0	2560	25090	2.4	24
M10		12.0	3109	30500	4.0	40
M10		13.0	4220	41360	4.2	42
M12		16.0	6420	62920	7.6	76

Inserti filettati RIVSERT ciechi

Closed end RIVSERT rivet nuts

SFTC

34001

■ Acciaio

Steel



Fusto cilindrico cieco

Closed end cylindrical shank

Testa tonda

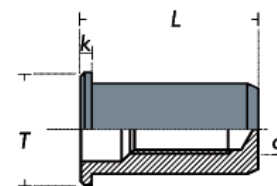
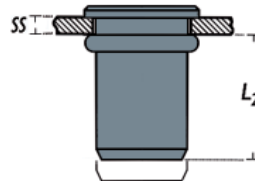
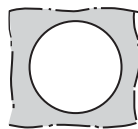
Dome head





d		T	k	SS	L	L ₂	Tipo	Codice		
mm	mm	mm	max	mm	mm	min ÷ max	Model	Item code	pz	pz
M3	5.0	7.0	0.8	0.3 ÷ 2.0	14.5	9.8 ÷ 10.3	SFTC0302005	1071300	1000S	20000
M4	6.0	9.0	1.0	0.5 ÷ 2.0	16.0	11.3 ÷ 12.0	SFTC0402006	0308400	1000N	8000
M5	7.0	10.0	1.2	2.5 ÷ 4.0	18.0	12.3 ÷ 13.0	SFTC0404006	0308500	1000N	8000
				3.0 ÷ 5.5	19.0		SFTC0503007	0308700	500N	6000
M6	9.0	12.0	1.5	0.5 ÷ 3.0	19.2	14.0 ÷ 14.5	SFTC0603009	0309000	250N	3000
				4.0 ÷ 6.0	21.0		SFTC0606009	1771100	250N	3000
M8	11.0	15.0	1.5	0.5 ÷ 3.0	21.5	17.5 ÷ 18.2	SFTC0803011	0309100	250N	2000
				3.0 ÷ 5.5	28.0		SFTC0805511	0309200	250P	1500
M10	13.0	17.0	1.6	0.5 ÷ 3.5	27.0	21.0 ÷ 22.0	SFTC1003513	0309500	100N	1000
				3.0 ÷ 6.0	32.5		SFTC1006013	0309600	100N	1000

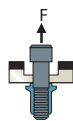

Applicazione

Application



d			Kg	N	Kgm	Nm
mm	mm	mm				
M3	5.0		430	4300	0.1	1
M4	6.0		740	7300	0.4	4
M5	7.0		1160	11450	0.7	7
M6	9.0		1720	16900	1.5	15
M8	11.0		2460	24200	2.6	26
M10	13.0		3160	31000	4.5	45

Inserti filettati RIVSERT ciechi

Closed end RIVSERT rivet nuts

SFSC

34011

■ Acciaio

Steel



Fusto cilindrico cieco

Closed end cylindrical shank

Testa svasata

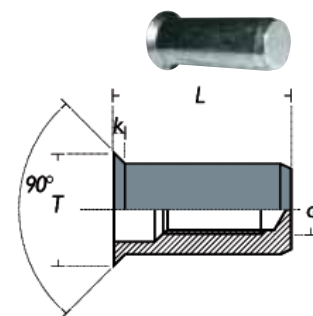
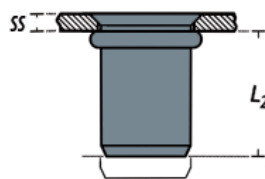
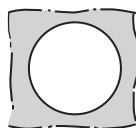
Countersunk head





d		T	k	SS	L	L ₂	Tipo	Codice		
mm	mm	mm	max	mm	mm	min ÷ max	Model	Item code	pz	pz
M4	6.0	9.0	1.5	1.3 ÷ 3.0	15.0	9.0 ÷ 10.0	SFSC0403006	0309800	1000N	8000
				3.0 ÷ 5.0	17.0	SFSC0405006	1071200	500S	8000	
M5	7.0	10.0	1.5	1.5 ÷ 4.0	20.0	13.0 ÷ 14.0	SFSC0504007	1712600	500N	6000
M6	9.0	12.0	1.5	1.5 ÷ 4.0	23.0	16.0 ÷ 17.0	SFSC0604009	0309900	250N	3000
				4.0 ÷ 6.5	26.0	SFSC0606509	0418800	250N	3000	
M8	11.0	14.0	1.5	1.5 ÷ 4.0	26.0	18.0 ÷ 19.0	SFSC0804011	0310000	250P	2000
				4.0 ÷ 6.5	29.0	SFSC0806511	0310200	250P	1500	
M10	13.0	15.0	1.5	1.5 ÷ 5.0	32.0	24.0 ÷ 25.0	SFSC1005013	0310300	100N	1000

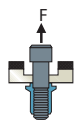

Applicazione
Application



d			Kg	N	Kgm	Nm
mm	mm	mm				
M4	6.0	6.0	740	7300	0.4	4
M5	7.0	7.0	1160	11450	0.7	7
M6	9.0	9.0	1720	16900	1.5	15
M8	11.0	11.0	2460	24200	2.6	26
M10	13.0	13.0	3160	31000	4.5	45

Inserti filettati RIVSERT zigrinati ciechi

Closed end RIVSERT knurled rivet nuts

SFTC-Z

34003

■ Acciaio

Steel



Fusto cilindrico zigrinato cieco

Closed end knurled cylindrical shank

Testa tonda

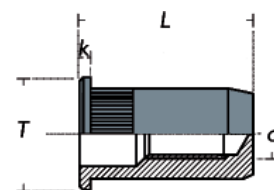
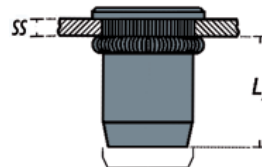
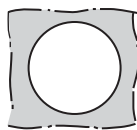
Dome head





d		T	k	SS	L	L ₂	Tipo	Codice		
mm	mm	mm	max	mm	mm	min ÷ max	Model	Item code	pz	pz
M3	5.0	8.0	0.8	0.5 ÷ 2.0	13.0	9.5 ÷ 10.5	SFTCZ0302005	4369400	1000S	20000
				1.5 ÷ 3.5	14.5	9.5 ÷ 10.5	SFTCZ0303505	3512900	1000S	20000
M4	6.0	9.0	0.8	0.5 ÷ 2.0	16.0	10.5 ÷ 11.5	SFTCZ0402006	3622500	1000N	8000
				2.0 ÷ 4.0	18.0	10.5 ÷ 11.5	SFTCZ0404006	4369300	1000N	8000
M5	7.0	10.0	1.0	0.5 ÷ 3.0	17.0	11.0 ÷ 12.0	SFTCZ0503007	2877600	500N	6000
				3.0 ÷ 5.0	19.0	11.0 ÷ 12.0	SFTCZ0505007	2516900	500N	5000
M6	9.0	12.0	1.3	0.5 ÷ 3.0	19.0	11.5 ÷ 13.0	SFTCZ0603009	3151800	250N	3000
				3.0 ÷ 5.0	21.0	11.5 ÷ 13.0	SFTCZ0605009	4369500	250N	3000
M8	11.0	15.0	1.5	0.5 ÷ 3.0	21.5	13.5 ÷ 15.0	SFTCZ0803011	3622600	250N	2000
				3.0 ÷ 5.5	24.0	13.5 ÷ 15.0	SFTCZ0805511	4369700	250P	1500
M10	13.0	17.0	1.6	1.0 ÷ 3.5	27.0	18.5 ÷ 20.0	SFTCZ1003513	4369800	100N	1000

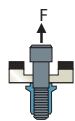

Applicazione
Application



d			Kg	N	Kgm	Nm
mm	mm	mm				
M3	5.0	5.0	430	4300	0.1	1
M4	6.0	6.0	740	7300	0.4	4
M5	7.0	7.0	1160	11450	0.7	7
M6	9.0	9.0	1720	16900	1.5	15
M8	11.0	11.0	2460	24200	2.6	26
M10	13.0	13.0	3160	31000	4.5	45

Inserti filettati RIVSERT zigrinati ciechi

Closed end RIVSERT knurled rivet nuts

SFRC-Z

34023

■ Acciaio

Steel



Fusto cilindrico zigrinato cieco

Closed end knurled cylindrical shank

Testa ridotta

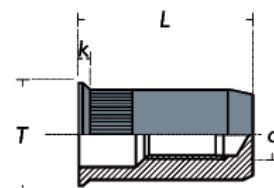
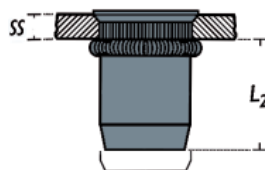
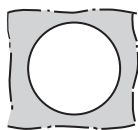
Reduced head





d		T	k	SS	L	L ₂	Tipo	Codice		
mm	mm	mm	max	mm	mm	min ÷ max	Model	Item code	pz	pz
M3	5.0	6.0	0.5	0.5 ÷ 2.0	13.5	9.5 ÷ 10.0	SFRCZ0302005	1664300	1000S	20000
				1.5 ÷ 3.5	14.0	SFRCZ0303505	1664400	1000S	20000	
M4	6.0	7.0	0.5	0.5 ÷ 2.0	15.0	10.5 ÷ 11.5	SFRCZ0402006	1664500	1000N	10000
				2.0 ÷ 3.0	16.0	SFRCZ0403006	1664600	1000N	10000	
M5	7.0	8.0	0.5	0.5 ÷ 2.0	16.5	12.0 ÷ 13.0	SFRCZ0502007	1529800	500N	7000
				2.0 ÷ 3.5	18.0	SFRCZ0503507	1571500	500N	7000	
M6	9.0	10.0	0.6	0.5 ÷ 3.0	20.5	15.0 ÷ 16.0	SFRCZ0603009	3309600	250N	3000
				2.5 ÷ 5.5	24.0	SFRCZ0605509	1664700	250N	3000	
				3.0 ÷ 6.0	26.5	SFRCZ0806011	1664900	200N	2000	
M8	11.0	12.0	0.6	1.0 ÷ 3.5	23.0	17.0 ÷ 18.0	SFRCZ0803511	1664800	250N	2000
				3.0 ÷ 4.5	24.5	SFRCZ0804511	4480900	250N	2000	
				3.0 ÷ 6.0	26.5	SFRCZ0806011	1664900	200N	2000	
M10	13.0	14.0	0.7	0.5 ÷ 3.5	29.0	18.0 ÷ 19.0	SFRCZ1003513	1665000	100N	1000
				3.0 ÷ 6.0	31.5	SFRCZ1006013	1665100	100N	1000	

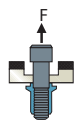

Applicazione

Application



d			Kg	N	Kgm	Nm
mm	mm	mm				
M3	5.0	5.0	430	4300	0.1	1
M4	6.0	6.0	744	7300	0.5	5
M5	7.0	7.0	1167	11450	0.7	7
M6	9.0	9.0	1723	16900	1.5	15
M8	11.0	11.0	2467	24200	3.3	32
M10	13.0	13.0	3160	31000	4.5	45

Inserti filettati RIVSERT zigrinati ciechi

Closed end RIVSERT knurled rivet nuts

SFSC-Z

34013

■ Acciaio

Steel



Fusto cilindrico zigrinato cieco

Closed end knurled cylindrical shank

Testa svasata

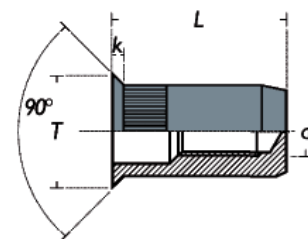
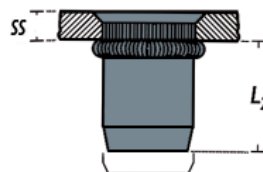
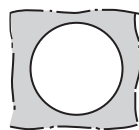
Countersunk head





d		T	k	SS	L	L ₂	Tipo	Codice		
mm	mm	mm	max	mm	mm	min ÷ max	Model	Item code	pz	pz
M4	6.0	9.0	1.5	1.5 ÷ 3.5	17.0	9.0 ÷ 10.0	SFSCZ0403006	1899400	1000N	8000
M5	7.0	10.0	1.5	1.5 ÷ 4.0	20.0	13.0 ÷ 14.0	SFSCZ0504007	1688300	500N	6000
M6	9.0	12.0	1.5	2.0 ÷ 4.5	23.5	16.0 ÷ 17.0	SFSCZ0604509	2992100	250N	3000
M8	11.0	14.0	1.5	1.5 ÷ 4.0	27.0	18.0 ÷ 19.0	SFSCZ0804011	1920400	250P	2000
M10	13.0	15.0	1.5	1.5 ÷ 5.0	32.0	24.0 ÷ 25.0	SFSCZ1005013	3254300	100N	1000

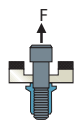

Applicazione

Application



d			Kg	N	Kgm	Nm
mm	mm	mm				
M4	6.0	6.0	740	7300	0.4	4
M5	7.0	7.0	1160	11450	0.7	7
M6	9.0	9.0	1720	16900	1.5	15
M8	11.0	11.0	2460	24200	2.6	26
M10	13.0	13.0	3160	31000	4.5	45

Inserti filettati RIVSERT ciechi

Closed end RIVSERT rivet nuts

SFTE

34006

■ Acciaio

Steel



Fusto esagonale cieco

Closed end hexagonal shank

Testa tonda

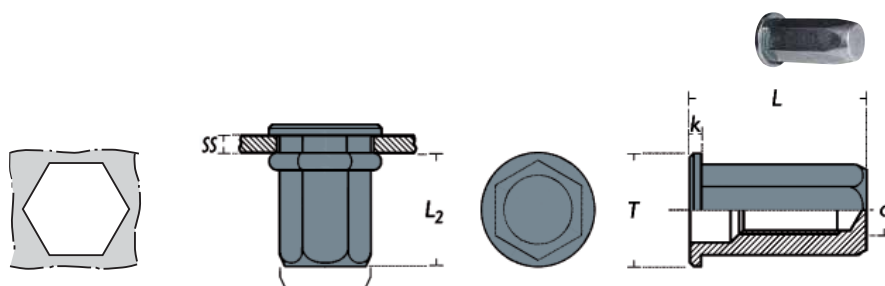
Dome head





d		T	k	SS	L	L ₂	Tipo	Codice		
mm	mm	mm	max	mm	mm	min ÷ max	Model	Item code	pz	pz
M4	6.0	9.0	1.0	0.5 ÷ 2.0	15.0	10.0 ÷ 11.0	SFTE0402006	1774700	1000N	8000
				1.5 ÷ 4.0	17.0	SFTE0404006	1774800	1000N	8000	
M5	7.0	10.0	1.0	0.5 ÷ 2.5	18.0	13.0 ÷ 14.0	SFTE0502507	1774900	500N	6000
				2.0 ÷ 4.5	20.0	SFTE0504507	1775000	500N	6000	
M6	9.0	13.0	1.5	0.5 ÷ 3.0	23.0	16.0 ÷ 17.0	SFTE0603009	1225100	250N	2500
		12.0	1.2	2.5 ÷ 5.5	25.0	SFTE0605509	1775100	250N	2500	
M8	11.0	16.0	1.5	0.5 ÷ 3.0	26.0	18.0 ÷ 19.0	SFTE0803011	1732000	250P	1500
		14.0	1.3	3.5 ÷ 6.0	27.5	SFTE0806011	1775200	200N	1500	
M10	13.0	19.0	2.0	1.0 ÷ 3.5	33.0	24.0 ÷ 25.0	SFTE1003513	1731900	100N	800
		17.0	1.7	3.0 ÷ 6.0	33.5	SFTE1006013	1775300	100N	600	

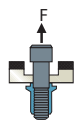

Applicazione
Application



d			Kg	N	Kgm	Nm
mm	mm	mm				
M4	6.0	6.0	680	6660	0.4	4
M5	7.0	7.0	1260	12350	0.7	7
M6	9.0	9.0	1770	17350	1.4	14
M8	11.0	11.0	2560	25090	2.4	24
M10	13.0	13.0	4220	41360	4.2	42

Inserti filettati RIVSERT ciechi

Closed end RIVSERT rivet nuts

SFRE

34026

■ Acciaio

Steel



Fusto esagonale cieco

Closed end hexagonal shank

Testa ridotta

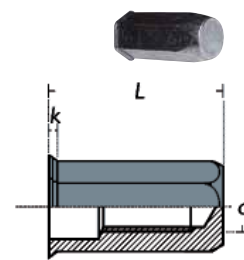
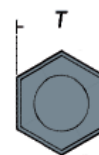
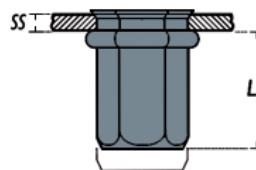
Reduced head





d		T	k	SS	L	L ₂	Tipo	Codice		
mm	mm	mm	max	mm	mm	min ÷ max	Model	Item code	pz	pz
M4	6.0	7.0	0.5	0.5 ÷ 2.0	16.0	11.0 ÷ 12.0	SFRE0402006	1772700	1000N	10000
				1.5 ÷ 4.0	16.5		SFRE0404006	1772800	1000N	10000
M5	7.0	8.0	0.5	0.5 ÷ 3.0	20.0	14.0 ÷ 15.0	SFRE0503007	0324700	500N	6000
				2.0 ÷ 4.5	20.0		SFRE0504507	1773000	500N	6000
M6	9.0	10.0	0.6	0.5 ÷ 3.0	21.0	16.0 ÷ 16.7	SFRE0603009	0324800	250N	3000
				2.5 ÷ 5.5	24.0		SFRE0605509	1773100	250N	3000
M8	11.0	12.0	0.6	0.5 ÷ 3.5	23.0	19.0 ÷ 20.0	SFRE0803511	1773200	250N	2000
				3.0 ÷ 6.0	27.5		SFRE0806011	1773300	200N	1500
M10	13.0	14.5	0.7	1.0 ÷ 4.5	28.5	20.5 ÷ 21.5	SFRE1004513	4369200	100N	1000
				3.0 ÷ 6.0	32.5		SFRE1006013	2445800	100N	1000

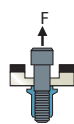

Applicazione
Application



d			Kg	N	Kgm	Nm
mm	mm	mm				
M4		6.0	680	6660	0.4	4
M5		7.0	1260	12350	0.7	7
M6		9.0	1770	17350	1.4	14
M8		11.0	2560	25090	2.4	24
M10		13.0	4220	41360	4.2	42

Inserti filettati RIVSERT A2

A2 RIVSERT rivet nuts

ITC/A2

34100

Acciaio inox A2

A2 stainless steel



Fusto cilindrico aperto

Open cylindrical shank

Testa tonda

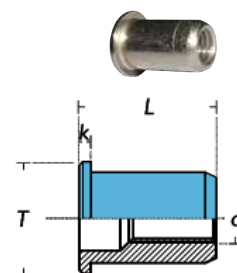
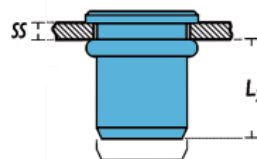
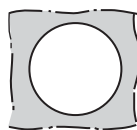
Dome head





d		T	k	SS	L	L ₂	Tipo	Codice		
mm	mm	mm	max	mm	mm	min ÷ max	Model	Item code	pz	pz
M3	5.0	6.0	0.8	0.8 ÷ 2.0	9.5	5.5 ÷ 5.8	ITCA20302005	0315100	1000S	20000
				1.5 ÷ 3.5	11.0	ITCA20303505	0315200	1000S	20000	
M4	6.0	9.0	1.0	0.5 ÷ 2.0	10.5	5.5 ÷ 6.0	ITCA20402006	2874400	500S	10000
				2.5 ÷ 4.0	13.0	ITCA20404006	3351300	500S	10000	
M5	7.0	10.0	1.2	0.5 ÷ 3.0	13.0	7.2 ÷ 7.7	ITCA20503007	2677600	250S	8000
				3.1 ÷ 4.0	15.5	ITCA20504007	3351400	250S	8000	
M6	9.0	12.0	1.5	0.5 ÷ 3.0	15.5	7.6 ÷ 8.2	ITCA20603009	2677700	250S	4000
				3.0 ÷ 4.5	16.0	ITCA20604509	2740400	250N	4000	
M8	11.0	15.0	1.5	0.5 ÷ 3.0	18.5	9.5 ÷ 10.1	ITCA20803011	2677800	250N	2500
				3.0 ÷ 6.0	20.0	ITCA20806011	3055800	200N	2000	
M10	13.0	17.0	1.7	1.0 ÷ 3.5	21.0	13.0 ÷ 14.0	ITCA21003513	4287600	100N	1500
				3.5 ÷ 6.0	24.0	ITCA21006013	1735500	100N	1000	
M12	16.0	23.0	2.0	1.0 ÷ 4.0	26.0	14.5 ÷ 15.5	ITCA21204016	3742900	100N	800

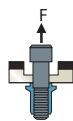

Applicazione
Application



d			Kg	N	Kgm	Nm
mm	mm	mm				
M3		5.0	380	3720	0.15	1.5
M4		6.0	630	6160	0.7	7
M5		7.0	1270	12450	1.4	14
M6		9.0	2330	22830	2.2	22
M8		11.0	3250	31850	3.2	32
M10		12.0	4050	39690	5.4	54
M10		13.0	4050	39690	5.4	54
M12		16.0	6500	63700	7.0	70

Inserti filettati RIVSERT A2

A2 RIVSERT rivet nuts

IRC/A2

34120

Acciaio inox A2

A2 stainless steel



Fusto cilindrico aperto

Open cylindrical shank

Testa ridotta

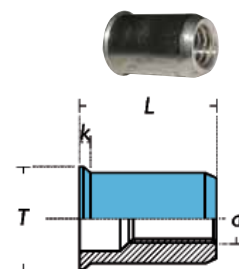
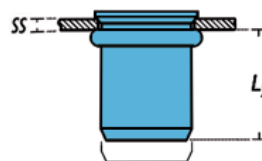
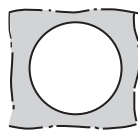
Reduced head





d		T	k	SS	L	L ₂	Tipo	Codice			€/1000
mm	mm	mm	max	mm	mm	min ÷ max	Model	Item code	pz	pz	
M3	5.0	5.5	0.3	0.5 ÷ 2.0	8.5	4.2 ÷ 4.6	IRCA20302005	3386200	1000S	20000	
M4	6.0	7.0	0.5	0.5 ÷ 2.0	10.5	6.5 ÷ 7.0	IRCA20402006	2734900	500S	16000	
				2.5 ÷ 4.0	13.0		IRCA20404006	4817100	500S	10000	
M5	7.0	8.0	0.5	0.5 ÷ 3.0	11.0	8.0 ÷ 8.5	IRCA20503007	2678100	500S	10000	
M6	9.0	10.0	0.5	0.5 ÷ 3.0	13.5	9.0 ÷ 9.7	IRCA20603009	2678200	250S	5000	
M8	11.0	12.0	0.5	1.0 ÷ 3.0	16.5	10.0 ÷ 11.5	IRCA20803011	2678300	250N	3000	
				3.0 ÷ 6.0	19.5		IRCA20806011	1054400	250N	3000	
M10	13.0	14.0	0.8	1.0 ÷ 3.5	20.0	12.0 ÷ 13.0	IRCA21003513	0388200	100S	1500	
				3.0 ÷ 6.0	23.0		IRCA21006013	4060100	100S	1500	

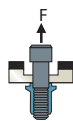

Applicazione
Application



d			Kg	N	Kgm	Nm
mm	mm	mm				
M3		5.0	380	3720	0.15	1.5
M4		6.0	630	6160	0.7	7
M5		7.0	1270	12450	1.4	14
M6		9.0	2330	22830	2.2	22
M8		11.0	3250	31850	3.2	32
M10		13.0	4050	39690	5.4	54

Inserti filettati RIVSERT A2 - foro in pollici

A2 RIVSERT rivet nuts - inch hole

IRC-P/A2

34120

■ Acciaio inox A2

A2 stainless steel



Fusto cilindrico aperto

Open cylindrical shank

Testa ridotta

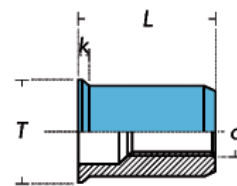
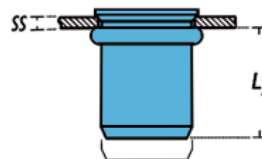
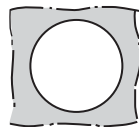
Reduced head





d		T	k	SS	L	L ₂	Tipo	Codice		
mm	mm	mm	max	mm	mm	min ÷ max	Model	Item code	pz	pz
M3	3/16 - 4.8	5.3	0.3	0.5 ÷ 1.5	9.0	5.2 ÷ 5.6	IRCPA20301505	1740800	1000S	20000
M4	1/4 - 6.4	6.9	0.5	0.5 ÷ 2.0	10.5	6.3 ÷ 6.7	IRCPA20402006	1740900	500S	16000
M5	9/32 - 7.2	7.7	0.5	0.5 ÷ 3.0	12.0	7.4 ÷ 7.8	IRCPA20503007	1741000	500S	10000
M6	3/8 - 9.6	10.2	0.5	0.7 ÷ 3.0	14.0	8.8 ÷ 9.6	IRCPA20603010	1741100	250S	5000
M8	13/13 - 10.6	11.3	0.5	1.0 ÷ 3.5	16.0	10 ÷ 10.8	IRCPA20803511	1741200	250N	3000

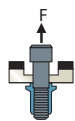

Applicazione
Application



d			Kg	N	Kgm	Nm
mm	mm	mm				
M3		4.8	380	3720	0.15	1.5
M4		6.4	630	6160	0.7	7
M5		7.2	1270	12450	1.4	14
M6		9.6	2330	22830	2.2	22
M8		10.6	3250	31850	3.2	32

Inserti filettati RIVSERT A4 (Aisi 316)

A4 RIVSERT rivet nuts (Aisi 316)

ITC/A4

34100

■ Acciaio inox A4

A4 stainless steel

Fusto cilindrico aperto

Open cylindrical shank

Testa tonda

Dome head

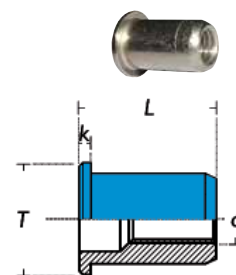
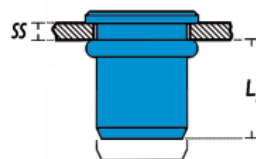
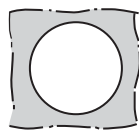

d		T	k	SS	L	L ₂	Tipo	Codice		
mm	mm	mm	max	mm	mm	min ÷ max	Model	Item code	pz	pz
M4	6.0	9.0	1.0	0.5 ÷ 2.0	11.0	6.0 ÷ 6.5	ITCA40402006	4769000	500S	10000
M5	7.0	10.0	1.0	0.5 ÷ 3.0	12.5	7.2 ÷ 7.7	ITCA40503007	4181100	250S	8000
M6	9.0	12.0	1.5	0.5 ÷ 3.0	16.0	7.6 ÷ 8.2	ITCA40603009	4421500	250S	4000
M8	11.0	15.0	1.5	0.5 ÷ 3.0	17.5	9.5 ÷ 10.1	ITCA40803011	4329400	250N	2500



Applicazione
Application

■ Acciaio inox A4

A4 stainless steel

Fusto cilindrico aperto

Open cylindrical shank

Testa ridotta

Reduced head

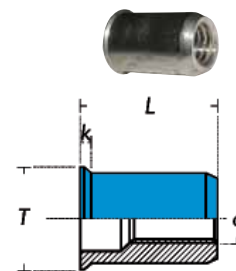
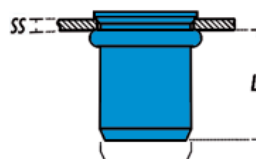

d		T	k	SS	L	L ₂	Tipo	Codice		
mm	mm	mm	max	mm	mm	min ÷ max	Model	Item code	pz	pz
M5	7.0	7.5	0.5	0.5 ÷ 3.0	12.0	8.0 ÷ 8.5	IRCA40503007	4421600	500S	10000
M6	9.0	9.5	0.5	0.5 ÷ 3.0	14.5	9.0 ÷ 9.7	IRCA40603009	4421700	250S	5000
M8	11.0	11.5	0.5	0.5 ÷ 3.0	16.0	10.7 ÷ 11.4	IRCA40803011	4421800	250N	3000



Applicazione
Application

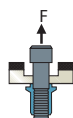

d		Pollici Inch	Kg	N	Kgm	Nm
mm						
M5		7.0	1270	12450	1.4	14
M6		9.0	2330	22830	2.2	22
M8		11.0	3250	31850	3.2	32

Inserti filettati RIVSERT A2 zigrinati

A2 RIVSERT knurled rivet nuts

ITC-Z/A2

34100

Acciaio inox A2

A2 stainless steel

Fusto cilindrico zigrinato aperto

Open knurled cylindrical shank

Testa tonda

Dome head

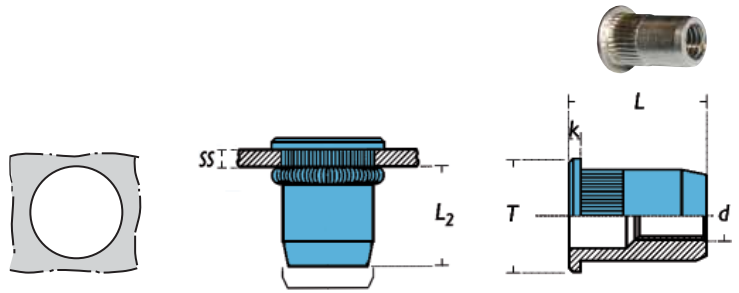

d		T	k	SS	L	L ₂	Tipo	Codice		
mm	mm	mm	max	mm	mm	min ÷ max	Model	Item code	pz	pz
M3	5.0	8.0	0.8	0.5 ÷ 2.0	9.0	5.5 ÷ 6.0	ITCZA20302005	3213900	1000S	10000
M4	6.0	9.0	1.0	0.5 ÷ 2.5	10.5	6.0 ÷ 6.5	ITCZA20402506	3214300	500S	10000
M5	7.0	10.0	1.2	2.5 ÷ 4.0	12.5	7.0 ÷ 8.0	ITCZA20404006	4328400	500S	10000
				0.5 ÷ 3.0	13.0					
M6	9.0	12.0	1.3	4.0 ÷ 6.0	17.0	8.0 ÷ 9.0	ITCZA20506007	3731500	250S	8000
				0.5 ÷ 3.0	15.5					
M8	11.0	15.0	1.5	3.5 ÷ 6.0	19.0	10.0 ÷ 11.5	ITCZA20603009	3214500	250S	4000
				1.0 ÷ 3.5	18.5					
M10	13.0	17.0	1.6	3.5 ÷ 6.0	21.0	12.5 ÷ 14.0	ITCZA20803511	3214600	250N	3000
				1.0 ÷ 3.5	21.0					
M10	13.0	17.0	1.6	1.0 ÷ 3.5	21.0	12.5 ÷ 14.0	ITCZA20806011	3279200	200N	2000
				3.0 ÷ 6.0	26.0					
		19.0	2.0	3.0 ÷ 6.0	26.0		ITCZA21006013	4325500	100N	1000



Applicazione
Application

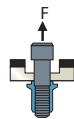

d			Kg	N	Kgm	Nm
mm	mm	mm				
M3	5.0	380	3720	0.15	1.5	
M4	6.0	630	6160	0.7	7	
M5	7.0	1270	12450	1.4	14	
M6	9.0	2330	22830	2.2	22	
M8	11.0	3250	31850	3.2	32	
M10	13.0	4050	39690	5.4	54	

Inserti filettati RIVSERT A2 zigrinati

A2 RIVSERT knurled rivet nuts

IRC-Z/A2

34121

Acciaio inox A2

A2 stainless steel

Fusto cilindrico zigrinato aperto

Open knurled cylindrical shank

Testa ridotta

Reduced head

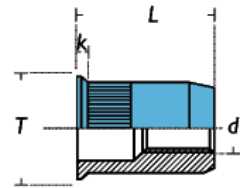
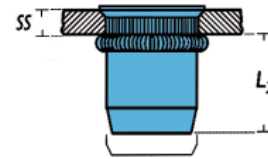
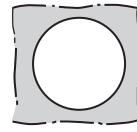

d		T	k	SS	L	L ₂	Tipo	Codice		
mm	mm	mm	max	mm	mm	min ÷ max	Model	Item code	pz	pz
M3	5.0	6.0	0.5	0.5 ÷ 1.5	8.5	4.0 ÷ 4.5	IRCZA20301505	3214000	1000S	20000
				1.5 ÷ 2.5	10.0		IRCZA20302505	4007400	1000S	20000
M4	6.0	7.0	0.5	0.5 ÷ 2.5	10.5	6.5 ÷ 7.0	IRCZA20402506	3214800	500S	16000
M5	7.0	8.0	0.5	0.5 ÷ 2.0	12.0	7.5 ÷ 8.5	IRCZA20502007	1740700	500S	10000
				2.5 ÷ 4.5	13.0		IRCZA20504507	1237500	250S	8000
M6	9.0	10.0	0.5	0.5 ÷ 3.0	14.0	8.5 ÷ 10.0	IRCZA20603009	3215000	250S	5000
				3.5 ÷ 6.0	17.5		IRCZA20606009	4281900	250S	4000
M8	11.0	12.0	0.5	1.0 ÷ 3.5	16.5	10.5 ÷ 11.5	IRCZA20803511	3215100	250N	3000
				3.0 ÷ 6.0	19.0		IRCZA20806011	4281800	250N	2500
M10	13.0	14.0	0.8	1.0 ÷ 3.5	18.0	11.0 ÷ 13.0	IRCZA21003513	3215200	100S	1500
				3.0 ÷ 6.0	23.0		IRCZA21006013	4811000	100S	1500



Applicazione
Application

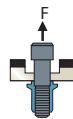

d			Kg	N	Kgm	Nm
mm	mm	mm				
M3		5.0	380	3720	0.15	1.5
M4		6.0	630	6160	0.7	7
M5		7.0	1270	12450	1.4	14
M6		9.0	2330	22830	2.2	22
M8		11.0	3250	31850	3.2	32
M10		13.0	4050	39690	5.4	54

Inserti filettati RIVSERT A2 zigrinati

A2 RIVSERT knurled rivet nuts

ISC-Z/A2

34111

Acciaio inox A2

A2 stainless steel

Fusto cilindrico zigrinato aperto

Open knurled cylindrical shank

Testa svasata

Countersunk head

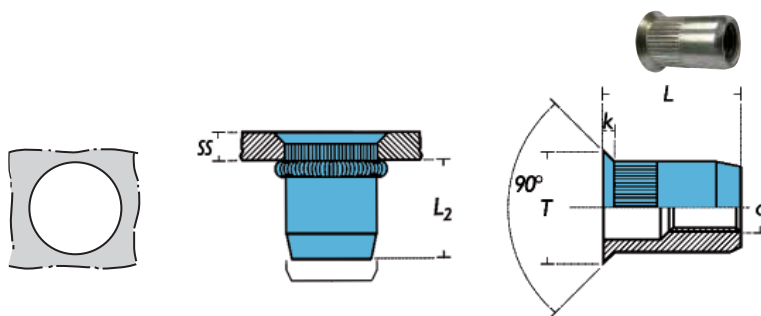

d		T	k	SS	L	L ₂	Tipo	Codice		
mm	mm	mm	max	mm	mm	min ÷ max	Model	Item code	pz	pz
M3	5.0	8.0	1.5	1.5 ÷ 3.0	11.5	4.5 ÷ 5.5	ISCZA20303005	4325000	1000S	20000
M4	6.0	9.0	1.5	1.5 ÷ 3.5	12.0	6.0 ÷ 6.5	ISCZA20403506	4368200	500S	10000
M5	7.0	10.0	1.5	1.5 ÷ 3.5	13.0	6.5 ÷ 7.0	ISCZA20503507	4325100	500S	8000
				2.0 ÷ 6.0	15.0	ISCZA20506007	4368300	250S	7000	
M6	9.0	12.0	1.5	1.5 ÷ 4.5	15.5	8.5 ÷ 9.5	ISCZA20604509	4312500	250S	4000
				4.5 ÷ 6.5	19.0	ISCZA20606509	3669400	250N	3000	
M8	11.0	14.0	1.5	1.5 ÷ 4.5	18.5	9.5 ÷ 11.0	ISCZA20804511	4331500	250N	2500
				3.5 ÷ 6.5	21.0	ISCZA20806511	4368400	250N	2000	
M10	13.0	16.0	1.5	1.5 ÷ 4.0	22.0	12.0 ÷ 14.5	ISCZA21004013	4325300	100S	2000
				3.5 ÷ 6.5	25.0	ISCZA21006513	4325400	50S	1200	



Applicazione
Application

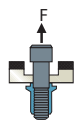

d			Kg	N	Kgm	Nm
mm	mm	mm				
M3	5.0	380	3720	0.15	1.5	
M4	6.0	630	6160	0.7	7	
M5	7.0	1270	12450	1.4	14	
M6	9.0	2330	22830	2.2	22	
M8	11.0	3250	31850	3.2	32	
M10	13.0	4050	39690	5.4	54	

Inserti filettati RIVSERT A2

A2 RIVSERT rivet nuts

ITEP/A2

34007

■ Acciaio inox A2

A2 stainless steel



Fusto semiesagonale aperto

Open semi-hexagonal shank

Testa tonda

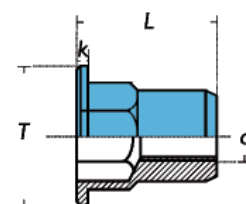
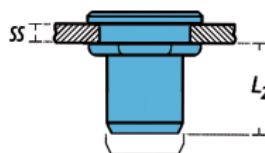
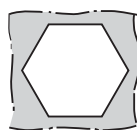
Dome head





d		T	k	SS	L	L ₂	Tipo	Codice		
mm	mm	mm	max	mm	mm	min ÷ max	Model	Item code	pz	pz
M4	6.0	9.0	0.8	0.5 ÷ 2.0	11.0	6.0 ÷ 6.5	ITEPA20402006	3214200	500S	10000
M5	7.0	10.0	1.0	0.5 ÷ 3.0	12.0	7.0 ÷ 8.0	ITEPA20503007	3215300	250S	8000
M6	9.0	13.0	1.3	0.5 ÷ 3.0	15.5	9.0 ÷ 10.0	ITEPA20603009	3215400	250S	4000
				3.5 ÷ 6.0	19.0		ITEPA20606009	4573100	250S	4000
M8	11.0	16.0	1.5	1.0 ÷ 3.5	18.0	11.0 ÷ 12.0	ITEPA20803511	3215500	250N	2000
				3.0 ÷ 6.0	20.0		ITEPA20806011	3769100	200N	1500
M10	13.0	19.0	2.0	1.0 ÷ 3.5	21.0	15.0 ÷ 16.0	ITEPA21003513	3215600	100N	1500
M12	16.0	23.0	2.0	1.0 ÷ 4.0	28.0	16.5 ÷ 17.5	ITEPA21204016	4520100	50S	1000

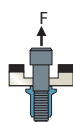

Applicazione
Application



d			Kg	N	Kgm	Nm
mm	mm	mm				
M4	6.0	6.0	540	5290	0.7	7
M5	7.0	7.0	1230	12050	1.4	14
M6	9.0	9.0	1660	16270	2.2	22
M8	11.0	11.0	3010	29500	3.2	32
M10	13.0	13.0	4100	40180	5.4	54
M12	16.0	16.0	6500	63700	7.0	70

Inserti filettati RIVSERT A2

A2 RIVSERT rivet nuts

IREP/A2

34127

Acciaio inox A2

A2 stainless steel



Fusto semiesagonale aperto

Open semi-hexagonal shank

Testa ridotta

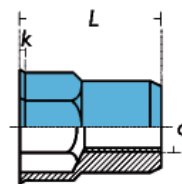
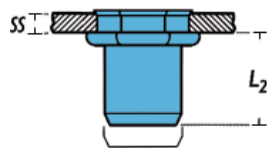
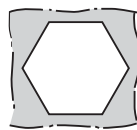
Reduced head





d		T	k	SS	L	L ₂	Tipo	Codice		
mm	mm	mm	max	mm	mm	min ÷ max	Model	Item code	pz	pz
M3	5.0	5.6	0.4	0.5 ÷ 1.5	8.5	5.0 ÷ 5.5	IREPA20301505	3730900	1000S	20000
M4	6.0	7.0	0.5	0.5 ÷ 2.0	12.0	6.5 ÷ 7.5	IREPA20402006	0383800	500S	14000
M5	7.0	8.0	0.5	2.0 ÷ 3.0	13.0	7.0 ÷ 8.0	IREPA20403006	3214100	500S	14000
				4.0 ÷ 6.0	17.0		IREPA20502507	3215700	500N	8000
M6	9.0	10.0	0.6	0.5 ÷ 3.0	16.0	9.0 ÷ 10.0	IREPA20506007	4353400	250S	8000
				3.0 ÷ 5.0	18.0		IREPA20603009	3215800	500N	4000
				0.8 ÷ 3.5	17.5	9.5 ÷ 10.5	IREPA20605009	3341200	250S	4000
M8	11.0	12.0	0.6	3.5 ÷ 6.0	20.0		IREPA20803511	3215900	250N	2500
				1.0 ÷ 3.5	21.0	11.0 ÷ 13.0	IREPA20806011	3314700	200N	2000
M10	13.0	14.5	0.7	3.0 ÷ 6.0	23.0		IREPA21003513	3216000	100S	1500
				1.0 ÷ 4.0	24.0	16.0 ÷ 18.0	IREPA21006013	4035900	100N	1000
M12	16.0	18.0	0.8	1.0 ÷ 4.0	24.0	16.0 ÷ 18.0	IREPA21204016	4331600	50S	1000

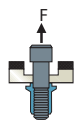

Applicazione

Application



d			Kg	N	Kgm	Nm
mm	mm	mm				
M3		5.0	390	3820	0.15	1.5
M4		6.0	540	5290	0.7	7
M5		7.0	1230	12050	1.4	14
M6		9.0	1660	16270	2.2	22
M8		11.0	3010	29500	3.2	32
M10		13.0	4100	40180	5.4	54
M12		16.0	6500	63700	7.0	70

Inserti filettati RIVSERT A4 (Aisi 316)

A4 RIVSERT rivet nuts (Aisi 316)

ITEP/A4

34104

Acciaio inox A4

A4 stainless steel



Fusto semiesagonale aperto

Open semi-hexagonal shank

Testa tonda

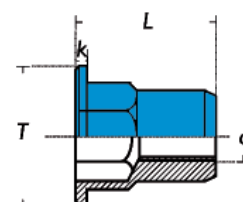
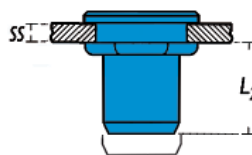
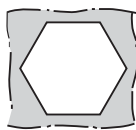
Dome head



d		T	k	SS	L	L ₂	Tipo	Codice		
mm	mm	mm	max	mm	mm	min ÷ max	Model	Item code	pz	pz
M5	7.0	10.0	1.0	0.5 ÷ 3.0	12.5	7.2 ÷ 7.7	ITEPA40503007	4125500	250S	8000
M6	9.0	12.0	1.5	0.5 ÷ 3.0	16.0	9.3 ÷ 9.7	ITEPA40603009	4422100	250S	4000
M8	11.0	15.0	1.5	0.5 ÷ 3.0	17.5	10.8 ÷ 11.5	ITEPA40803011	4194900	250N	2000
M10	13.0	17.0	1.5	0.8 ÷ 3.5	23.0	15.0 ÷ 16.5	ITEPA41003513	5018600	100N	1500



Applicazione
Application

Acciaio inox A4

A4 stainless steel

Fusto semiesagonale aperto

Open semi-hexagonal shank

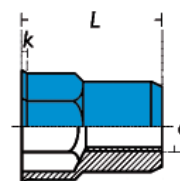
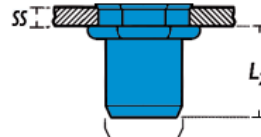
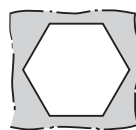

Testa ridotta

Reduced head



IREP/A4



34127

d		T	k	SS	L	L ₂	Tipo	Codice		
mm	mm	mm	max	mm	mm	min ÷ max	Model	Item code	pz	pz
M4	6.0	6.5	0.5	0.5 ÷ 2.0	12.0	6.5 ÷ 7.5	IREPA4040206	4632600	500S	14000
M5	7.0	8.0	0.7	0.5 ÷ 3.0	14.0	6.8 ÷ 7.2	IREPA4050307	4421900	250S	8000
M6	9.0	10.0	0.7	0.5 ÷ 3.0	14.5	9.4 ÷ 9.6	IREPA4060309	4230600	250S	4000
M8	11.0	12.0	0.7	0.5 ÷ 3.0	17.0	9.5 ÷ 10.0	IREPA4080311	4422000	250N	2500

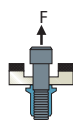

Applicazione
Application



d			Kg	N	Kgm	Nm
mm	mm	mm				
M4		6.0	530	5195	0.7	7
M5		7.0	1230	12060	1.4	14
M6		9.0	2300	22540	2.2	22
M8		11.0	3210	31460	3.2	32
M10		13.0	4100	40180	5.4	54

Inserti filettati RIVSERT A2 ciechi

Closed end A2 RIVSERT rivet nuts

SITC/A2

00000

Acciaio inox A2

A2 stainless steel



Fusto cilindrico cieco

Closed end cylindrical shank

Testa tonda

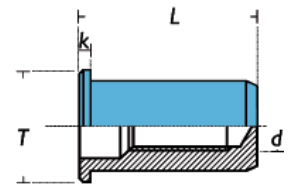
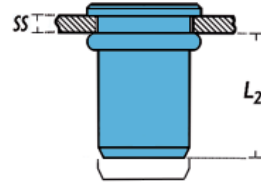
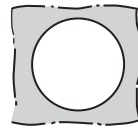
Dome head





d		T	k	SS	L	L ₂	Tipo	Codice		
mm	mm	mm	max	mm	mm	min ÷ max	Model	Item code	pz	pz
M4	6.0	9.0	0.8	0.5 ÷ 2.0	16.0	10.5 ÷ 11.5	SITCA20402006	4555500	250S	8000
M5	7.0	10.0	1.0	0.5 ÷ 2.5	19.0	12.0 ÷ 13.0	SITCA20502507	4555600	250S	6000
M6	9.0	12.0	1.5	0.5 ÷ 3.0	22.5	13.0 ÷ 14.0	SITCA20603009	4406900	250N	3000
M8	11.0	15.0	1.5	1.0 ÷ 3.5	25.0	14.0 ÷ 16.0	SITCA20803511	4467600	200N	2000
M10	13.0	17.0	1.5	0.8 ÷ 3.5	30.0	16.0 ÷ 18.0	SITCA21003513	4543700	50S	1000

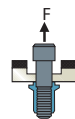

Applicazione
Application



d			Kg	N	Kgm	Nm
mm	mm	mm				
M4	6.0	6.0	630	6160	0.7	7
M5	7.0	7.0	1270	12450	1.4	14
M6	9.0	9.0	2330	22830	2.2	22
M8	11.0	11.0	3250	31850	3.2	32
M10	13.0	13.0	4050	39690	5.4	54

Inserti filettati RIVSERT A2 zigrinati ciechi

Closed end A2 RIVSERT knurled rivet nuts

SITC-Z/A2

34103

Acciaio inox A2

A2 stainless steel

Fusto cilindrico zigrinato cieco

Closed end knurled cylindrical shank

Testa tonda

Dome head

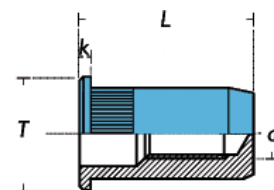
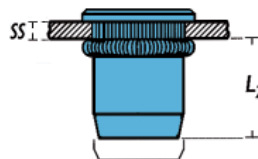
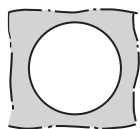

d		T	k	SS	L	L ₂	Tipo	Codice		
mm	mm	mm	max	mm	mm	min ÷ max	Model	Item code	pz	pz
M4	6.0	9.0	0.8	0.5 ÷ 2.0	16.0	10.5 ÷ 11.5	SITCZA20402006	1922800	250S	8000
M5	7.0	10.0	1.0	0.5 ÷ 2.5	17.0	12.0 ÷ 13.0	SITCZA20502507	3009700	250S	6000
M6	9.0	12.0	1.5	0.5 ÷ 3.0	19.0	13.0 ÷ 14.0	SITCZA20603009	3009800	250N	3000
M8	11.0	15.0	1.5	1.0 ÷ 3.5	21.5	14.0 ÷ 15.0	SITCZA20803511	4368000	200N	2000
M10	13.0	17.0	1.5	0.8 ÷ 3.5	30.0	16.0 ÷ 18.0	SITCZA21003513	4368100	50S	1000



Applicazione
Application

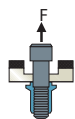

d		Kg	N	Kgm	Nm
mm	mm				
M4	6.0	630	6160	0.7	7
M5	7.0	1270	12450	1.4	14
M6	9.0	2330	22830	2.2	22
M8	11.0	3250	31850	3.2	32
M10	13.0	4050	39690	5.4	54

Inserti filettati RIVSERT A2 zigrinati ciechi

Closed end A2 RIVSERT knurled rivet nuts

SIRC-Z/A2

34124

■ Acciaio inox A2

A2 stainless steel

Fusto cilindrico zigrinato cieco

Closed end knurled cylindrical shank

Testa ridotta

Reduced head

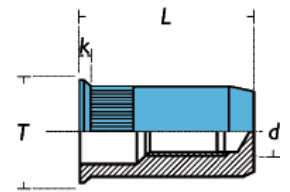
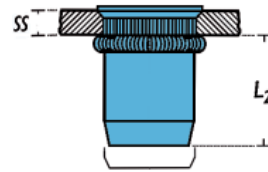
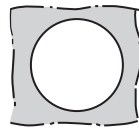

d		T	k	SS	L	L ₂	Tipo	Codice		
mm	mm	mm	max	mm	mm	min ÷ max	Model	Item code	pz	pz
M4	6.0	7.0	0.5	0.5 ÷ 2.0	15.0	10.5 ÷ 11.5	SIRCZA20402006	3158300	250S	10000
M5	7.0	8.0	0.5	0.5 ÷ 2.5	16.5	12.0 ÷ 13.0	SIRCZA20502507	2538300	250S	7000
M6	9.0	10.0	0.6	0.5 ÷ 3.0	20.5	15.0 ÷ 16.0	SIRCZA20603009	2610400	250N	3000
M8	11.0	12.0	0.6	1.0 ÷ 3.0	23.0	17.0 ÷ 18.0	SIRCZA20803011	4367800	250N	2000
M10	13.0	14.0	0.7	1.0 ÷ 3.5	24.5	18.0 ÷ 19.0	SIRCZA21003513	4367900	50S	1000



Applicazione
Application

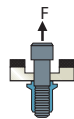

d			Kg	N	Kgm	Nm
mm	mm	mm				
M4	6.0	6.0	630	6160	0.7	7
M5	7.0	7.0	1270	12450	1.4	14
M6	9.0	9.0	2330	22830	2.2	22
M8	11.0	11.0	3250	31850	3.2	32
M10	13.0	13.0	4050	39690	5.4	54

Inserti filettati RIVSERT A2

A2 RIVSERT rivet nuts

SITEP/A2

34105

■ Acciaio inox A2

A2 stainless steel



Fusto semiesagonale cieco

Closed end semi-hexagonal shank

Testa tonda

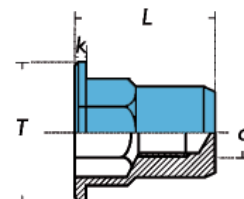
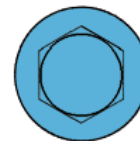
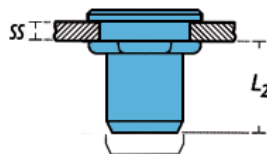
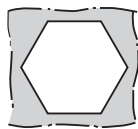
Dome head





d		T	k	SS	L	L ₂	Tipo	Codice		
mm	mm	mm	max	mm	mm	min ÷ max	Model	Item code	pz	pz
M4	6.0	9.0	1.0	0.5 ÷ 2.0	16.0	10.5 ÷ 11.5	SITEPA20402006	3737400	250S	8000
M5	7.0	10.0	1.0	0.5 ÷ 3.0	18.0	12.5 ÷ 13.5	SITEPA20503007	4420800	250S	6000
M6	9.0	12.0	1.5	0.5 ÷ 3.0	23.0	15.5 ÷ 16.5	SITEPA20603009	4118800	250N	2500
M8	11.0	15.0	1.5	0.5 ÷ 3.0	25.0	17.8 ÷ 19.0	SITEPA20803011	4332000	250P	1500

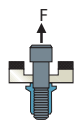

Applicazione
Application



d			Kg	N	Kgm	Nm
mm	mm	mm				
M4	6.0	6.0	540	5290	0.7	7
M5	7.0	7.0	1230	12050	1.4	14
M6	9.0	9.0	1660	16270	2.2	22
M8	11.0	11.0	3010	29500	3.2	32

Inserti filettati RIVSERT A2

A2 RIVSERT rivet nuts

SIREP/A2

34128

■ Acciaio inox A2

A2 stainless steel



Fusto semiesagonale cieco

Closed end semi-hexagonal shank

Testa ridotta

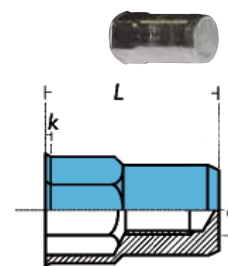
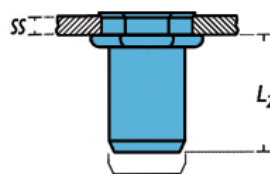
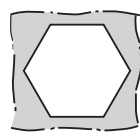
Reduced head



d		T	k	SS	L	L ₂	Tipo	Codice		
mm	mm	mm	max	mm	mm	min ÷ max	Model	Item code	pz	pz
M4	6.0	7.0	0.5	0.5 ÷ 2.0	15.5	10.5 ÷ 11.5	SIREPA20402006	1664100	250S	10000
M5	7.0	8.0	0.5	0.5 ÷ 3.0	18.0	12.5 ÷ 13.5	SIREPA20503007	3493100	250S	6000
M6	9.0	10.0	0.6	3.0 ÷ 5.0	20.5	15.0 ÷ 16.0	SIREPA20505007	4323400	250S	6000
				0.5 ÷ 3.0	21.5	15.0 ÷ 16.0	SIREPA20603009	3369000	250N	3000
M8	11.0	12.0	0.6	3.0 ÷ 5.0	23.5		SIREPA20605009	4179000	250N	3000
				0.5 ÷ 3.0	24.0	17.5 ÷ 18.5	SIREPA20803011	3369100	250N	2000

Inserti filettati RIVSERT A4 (Aisi 316)

A4 RIVSERT rivet nuts (Aisi 316)

SIREP/A4

34128

■ Acciaio inox A4

A4 stainless steel



Fusto semiesagonale cieco

Closed end semi-hexagonal shank

Testa ridotta

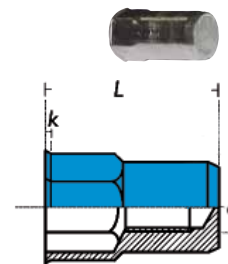
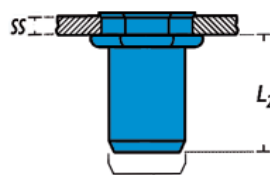
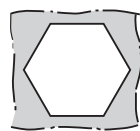
Reduced head





d		T	k	SS	L	L ₂	Tipo	Codice		
mm	mm	mm	max	mm	mm	min ÷ max	Model	Item code	pz	pz
M4	6.0	6.5	0.5	0.5 ÷ 2.0	15.5	10.5 ÷ 11.5	SIREPA40402006	4860000	250S	10000
M5	7.0	7.5	0.5	0.5 ÷ 3.0	18.0	12.5 ÷ 13.5	SIREPA40503007	4864300	250S	6000
M6	9.0	9.5	0.5	0.5 ÷ 3.0	21.5	15.0 ÷ 16.0	SIREPA40603009	4853100	250S	6000
M8	11.0	11.5	0.5	0.5 ÷ 3.0	24.0	17.5 ÷ 18.5	SIREPA40603011	4864500	250N	3000

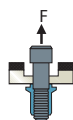

Applicazione

Application



d			Kg	N	Kgm	Nm
mm	mm	mm				
M4	6.0	6.0	540	5290	0.7	7
M5	7.0	7.0	1230	12050	1.4	14
M6	9.0	9.0	1660	16270	2.2	22
M8	11.0	11.0	3010	29500	3.2	32

Inserti filettati RIVSERT ciechi con guarnizione

Closed end RIVSERT rivet nuts with washer

STREP-G

34105

■ Acciaio inox A4

A4 stainless steel



Fusto semiesagonale cieco

Closed end semi-hexagonal shank

Testa tonda c/guarnizione in gomma NBR 70-95

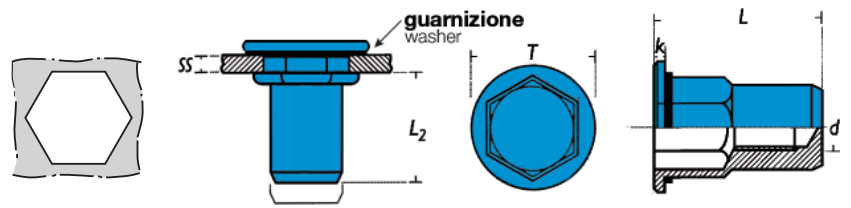
Dome head with underhead seal is rubber NBR 70-95



d		T	k	SS	L	L ₂	Tipo	Codice			€/1000
mm	mm	mm	max	mm	mm	min ÷ max	Model	Item code	pz	pz	
M5	7.0	13.5	1.5	0.5 ÷ 3.0	20.5	-	STREPG0503007	5102800	500N	6000	
M6	9.0	16.0	1.5	0.5 ÷ 3.0	23.0	-	STREPG0603009	5102900	250N	3000	
M8	11.0	21.0	2.0	0.5 ÷ 3.0	27.0	-	STREPG0803011	5103000	250N	2000	



Applicazione
Application

Vantaggi

L'inserto garantisce una resistenza elevata alla corrosione e un'ottima tenuta impermeabile grazie alla guarnizione sottotesta.

Benefits

The rivet nut ensures an extra high corrosion resistance and an excellent waterproof sealing thanks to the underhead sealing.

Inserti filettati RIVSERT

RIVSERT rivet nuts

ATC

34200

Alluminio

Aluminium

Fusto cilindrico aperto

Open cylindrical shank

Testa tonda

Dome head

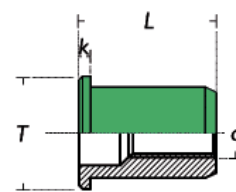
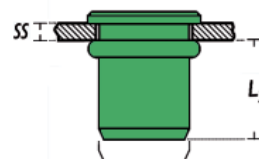
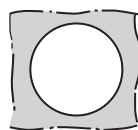

d		T	k	SS	L	L ₂	Tipo	Codice		
mm	mm	mm	max	mm	mm	min ÷ max	Model	Item code	pz	pz
M3	5.0	7.0	0.8	0.5 ÷ 2.0	9.0	4.2 ÷ 4.6	ATC0302005	0293800	1000S	20000
				2.0 ÷ 3.0	10.5		ATC0303005	0293900	1000S	20000
M4	6.0	9.0	1.0	0.3 ÷ 2.5	10.5	5.5 ÷ 6.0	ATC0402506	0294100	1000N	10000
				2.5 ÷ 4.0	13.0		ATC0404006	0294200	1000N	10000
M5	7.0	10.0	1.2	0.5 ÷ 3.0	13.0	7.2 ÷ 7.7	ATC0503007	0294300	500N	8000
				3.0 ÷ 5.0	15.5		ATC0505007	0294500	500N	8000
M6	9.0	12.0	1.5	0.5 ÷ 2.5	15.0	7.6 ÷ 8.2	ATC0602509	0294700	500N	4000
				3.0 ÷ 4.0	16.0		ATC0604009	3740000	500N	4000
				4.0 ÷ 6.0	17.5		ATC0606009	0295000	500P	3000
M8	11.0	15.0	1.5	0.8 ÷ 3.5	16.5	9.1 ÷ 10.1	ATC0803511	2582300	250N	2500
				3.5 ÷ 6.0	20.0		ATC0806011	0295300	250N	2000
M10	12.0	16.0	1.7	1.0 ÷ 3.5	19.0	10.7 ÷ 11.5	ATC1003512	0295400	200N	1500
				3.5 ÷ 6.0	22.0		ATC1006012	0295500	100N	1000
M10	13.0	17.0	1.7	1.0 ÷ 3.5	21.0	12.5 ÷ 13.5	ATC1003513	2582500	100N	1500
				3.5 ÷ 6.0	24.0		ATC1006013	2582600	100N	1000



Applicazione
Application

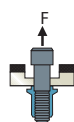

d			Kg	N	Kgm	Nm
mm	mm	mm				
M3		5.0	265	2600	0.07	0.7
M4		6.0	398	3900	0.2	2.5
M5		7.0	601	5900	0.5	5
M6		9.0	877	8600	0.8	8
M8		11.0	1040	10200	2	20
M10		12.0	1427	14000	2.5	25
M10		13.0	1529	15000	2.5	25

Inserti filettati RIVSERT

RIVSERT rivet nuts

ARC

34213

Alluminio

Aluminium



Fusto cilindrico aperto

Open cylindrical shank

Testa ridotta

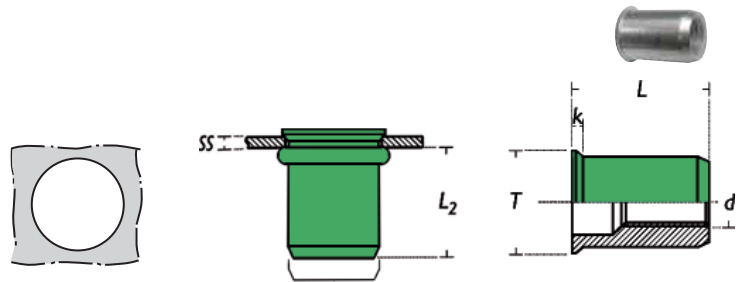
Reduced head





d		T	k	SS	L	L ₂	Tipo	Codice		
mm	mm	mm	max	mm	mm	mm	Model	Item code	pz	pz
M4	6.0	7.0	0.5	0.5 ÷ 2.0	10.5	6.0	ARC0402006	4367400	1000N	16000
M5	7.0	8.0	0.5	0.5 ÷ 3.0	11.5	6.3	ARC0503007	4364900	1000N	10000
M6	9.0	10.0	0.5	0.5 ÷ 3.0	14.5	8.6	ARC0603009	4367500	500N	5000
M8	11.0	12.0	0.5	0.5 ÷ 3.0	16.5	10.0	ARC0803011	4367600	250N	3000

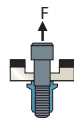

Applicazione

Application



d			Kg		Nm	
mm	mm	mm		N	Kgm	
M4	6.0	6.0	398	3900	0.2	2.5
M5	7.0	7.0	601	5900	0.5	5
M6	9.0	9.0	877	8600	0.8	8
M8	11.0	11.0	1040	10200	2	20

Inserti filettati RIVSERT

RIVSERT rivet nuts

ASC

34210

Alluminio

Aluminium



Fusto cilindrico aperto

Open cylindrical shank

Testa svasata

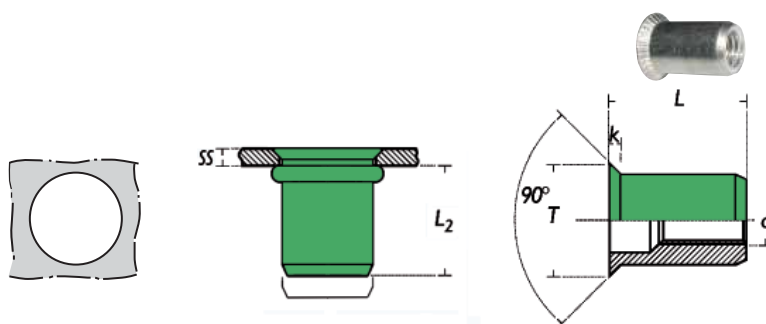
Countersunk head





d		T	k	SS	L	L ₂	Tipo	Codice		
mm	mm	mm	max	mm	mm	min ÷ max	Model	Item code	pz	pz
M3	5.0	8.0	1.5	1.5 ÷ 3.0	9.5	4.7 ÷ 5.3	ASC0303005	2697000	1000S	20000
				3.0 ÷ 4.0	10.5		ASC0304005	2697100	1000S	20000
M4	6.0	9.0	1.5	1.5 ÷ 3.5	12.0	5.3 ÷ 6.1	ASC0403506	0296300	1000N	10000
				3.5 ÷ 5.0	13.0		ASC0405006	0296500	1000N	10000
M5	7.0	10.0	1.5	1.5 ÷ 3.5	13.0	6.8 ÷ 7.3	ASC0503507	0296600	1000N	8000
				3.5 ÷ 6.0	15.0		ASC0506007	0198600	500N	7000
M6	9.0	12.0	1.5	1.5 ÷ 3.5	15.5	8.5 ÷ 9.2	ASC0603509	0297100	500N	4000
				3.5 ÷ 6.0	17.0		ASC0606009	0297200	500P	3000
M8	11.0	14.0	1.5	1.5 ÷ 3.5	16.5	9.5 ÷ 10.4	ASC0803511	0297300	250N	2500
				3.5 ÷ 6.0	19.0		ASC0806011	0297500	250N	2000
M10	13.0	15.0	1.5	1.5 ÷ 3.5	18.0	11.0 ÷ 12.0	ASC1003513	0297600	200N	2000
				3.5 ÷ 6.0	20.5		ASC1006013	0297700	100N	1200

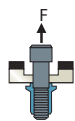

Applicazione

Application



d			Kg	N	Kgm	Nm
mm	mm	mm				
M3		5.0	265	2600	0.07	0.7
M4		6.0	398	3900	0.2	2.5
M5		7.0	601	5900	0.5	5
M6		9.0	877	8600	0.8	8
M8		11.0	1040	10200	2	20
M10		12.0	1427	14000	2.5	25

Inserti filettati RIVSERT ciechi

Closed end RIVSERT rivet nuts

SATC

34201

Alluminio

Aluminium

Fusto cilindrico cieco

Closed end cylindrical shank

Testa tonda

Dome head

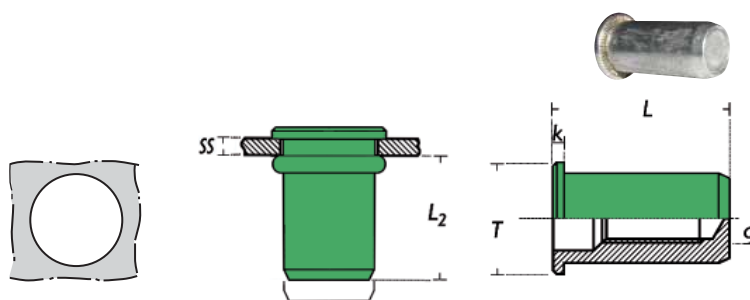

d		T	k	SS	L	L ₂	Tipo	Codice		
mm	mm	mm	max	mm	mm	min ÷ max	Model	Item code	pz	pz
M4	6.0	9.0	1.0	0.5 ÷ 2.5	16.5	11.3 ÷ 12.0	SATC0402506	1085500	1000N	8000
				2.5 ÷ 4.0	18.0		SATC0404006	1085200	1000N	8000
M5	7.0	10.0	1.2	0.5 ÷ 3.0	18.0	12.3 ÷ 13.0	SATC0503007	2866400	500N	6000
M6	9.0	12.0	1.5	0.5 ÷ 2.3	20.5	14.0 ÷ 14.5	SATC0602309	1661900	500N	3000
M8	11.0	15.0	1.5	0.8 ÷ 3.5	25.5	17.5 ÷ 18.2	SATC0803511	3646700	250N	2000
				3.5 ÷ 6.0	28.0		SATC0806011	0297900	250P	1500



Applicazione

Application

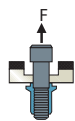

d			Kg	N	Kgm	Nm
mm	mm	mm				
M4	6.0		398	3900	0.2	2.5
M5	7.0		601	5900	0.5	5
M6	9.0		877	8600	0.8	8
M8	11.0		1040	10200	2	20

Inserti filettati RIVSERT

RIVSERT rivet nuts

OTC

34300

Ottone

Brass

Fusto cilindrico aperto

Open cylindrical shank

Testa tonda

Dome head

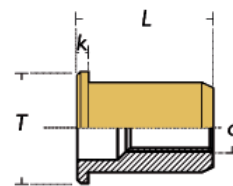
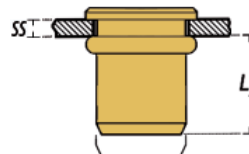
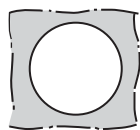

d		T	k	SS	L	L ₂	Tipo	Codice		
mm	mm	mm	max	mm	mm	min ÷ max	Model	Item code	pz	pz
M5	7.0	10.0	1.0	0.5 ÷ 2.0	13.0	7.0 ÷ 8.0	OTC0502007	0323500	500N	8000
M6	9.0	13.0	1.5	0.5 ÷ 3.0	16.0	8.0 ÷ 9.0	OTC0603009	0323700	500N	4000
M8	11.0	15.0	1.5	1.0 ÷ 3.5	18.5	9.0 ÷ 10.0	OTC0803511	0324000	250N	2500
M10	13.0	19.0	2.0	0.8 ÷ 3.5	23.0	12.5 ÷ 14.5	OTC1003513	3749200	100N	1200



Applicazione

Application

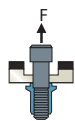

d			Kg	N	Kgm	Nm
mm	mm	mm				
M5	7.0	7.0	700	6860	0.6	6
M6	9.0	9.0	980	9600	1.0	10
M8	11.0	11.0	1100	10780	2.0	20
M10	13.0	13.0	1520	14900	2.5	25

Inserti filettati THINSERT

THINSERT rivet nuts

FRTH

34900

■ Acciaio

Steel



Fusto cilindrico aperto

Open cylindrical shank

Testa ridotta

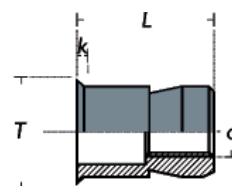
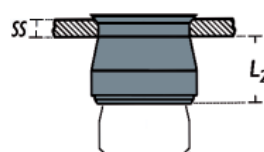
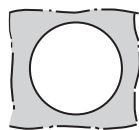
Reduced head



d		T	k	SS	L	L ₂	Tipo	Codice		
mm	mm	mm	max	mm	mm	mm	Model	Item code	pz	pz
M3	5.0	5.2	0.4	≥ 0.8	9.0	5.0	FRTH0300805	03250ZB	500S	20000
M4	6.5	6.9	0.4	≥ 0.8	10.0	5.0	FRTH0400806	03251ZB	500S	10000
M5	7.25	7.5	0.6	≥ 0.8	10.0	5.0	FRTH0500807	03252ZB	500S	8000
M6	9.75	10.0	0.6	≥ 0.8	13.0	7.0	FRTH0600810	03253ZB	500N	4000
M8	13.0	13.5	0.7	≥ 0.8	15.5	8.0	FRTH0800813	03254ZB	250N	2500

A richiesta con fusto zigrinato | Knurled shank on request



Applicazione
Application

Attrezzi per la posa
Relating tools
RIV806 - Cod. 4197000
RIV810 - Cod. 4197100

Per una corretta installazione dell'inserto occorre una rivettatrice che abbia una corsa graduale.

For a proper installation a tool with gradual stroke is required.

Vantaggi

L'inserto THINSERT viene utilizzato su spessore sottile o pieno oppure quando si hanno problematiche di ingombro, in quanto una volta installato la sporgenza è minima.

Benefits

The rivet nuts THINSERT is used on thin or full thickness, or when you have problems of encumbrance, because the protrusion once installed is minimal.



d	Ø foro della piastra Plate hole Ø	Massima coppia applicabile Maximum applicable torque		
		SS = 0.88 mm	SS = 3.0 mm	SS = >3.0 mm
M3	5.0	3.50	3.50	3.50
M4	6.5	4.00	4.00	4.00
M5	7.25	15.75	16.25	15.30
M6	9.75	27.00	24.75	25.60
M8	13.0	50.75	53.50	52.00

Inserti filettati quadri SQUARIV

SQUARIV square rivet nuts

SQF

340SQB

■ **Acciaio**

Steel



Fusto quadrato aperto

Open square shank

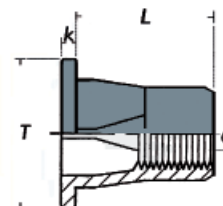
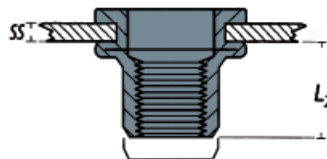
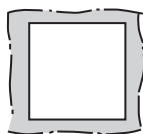

Testa tonda

Dome head

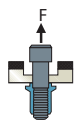

d		T	k	SS	L	L ₂	Tipo	Codice		
mm	mm	mm	max	mm	mm	mm	Model	Item code	pz	pz
M5	7.0 x 7.0	10.5	0.60	0.5 ÷ 1.5	11.2	8.0	SQF0501506	4596400	500N	8000
M6	9.0 x 9.0	14.0	0.80	0.5 ÷ 2.5	14.3	8.5	SQF0602508	4596500	500N	4000



d			Kg	N	Kgm	Nm
mm	mm	mm				
M5	7.0 x 7.0	7.0 x 7.0	1260	12350	0.7	7.0
M6	9.0 x 9.0	9.0 x 9.0	1770	17350	1.4	14.0

Inserti filettati per materiali soft JACKRIV

JACKRIV soft materials rivet nuts

JKF

34700

■ **Acciaio**

Steel



Fusto cilindrico aperto

Open cylindrical shank

Testa tonda

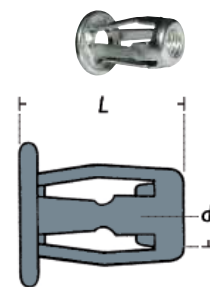
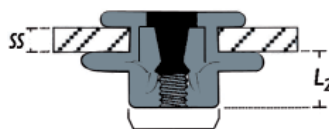
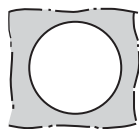
Dome head



d		SS	L	L ₂	Tipo	Codice		
mm	mm	mm	mm	mm	Model	Item code	pz	pz
M4	8.0	0.4 ÷ 4.8	17.0	5.0	JKF0404808	29069ZB	500N	5000
		4.8 ÷ 9.5	22.0	5.5	JKF0409508	29070ZB	500P	4000
M5	10.0	0.4 ÷ 4.8	18.0	5.0	JKF0504810	29071ZB	250N	3000
		4.8 ÷ 9.5	23.0	5.5	JKF0509510	29072ZB	250N	2500
M6	12.0	0.4 ÷ 4.8	18.0	5.0	JKF0604811	29073ZB	250N	2000
		4.8 ÷ 9.5	23.0	5.5	JKF0609511	29074ZB	250N	2000
M8	14.5	5.0 ÷ 12.0	25.2	6.0	JKF0812014	32124ZB	200P	1000

Consigliato per essere applicato su compensato, plastica, vetroresina, ecc.
Recommended to be applied on plywood, plastic, fiberglass, etc.



Applicazione
Application





Attrezzo per la posa RIV916
Relating tool RIV916
Cod. 4154500

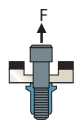

Attrezzo per la posa RIV903C
Relating tool RIV903C
Cod. 3675800



d			Kg	N	Kgm	Nm
mm	mm	mm				
M4	8.0		25	245	1.0	10
M5	10.0		30	294	1.4	14
M6	11.0		35	343	1.4	14
M8	14.5		50	490	2.8	28

Inserti filettati per materiali soft JACKRIV A4

A4 JACKRIV soft materials rivet nuts

JKI/A4

34700

■ Acciaio inox Aisi 316

Aisi 316 stainless steel



Fusto cilindrico aperto

Open cylindrical shank

Testa tonda

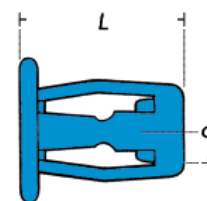
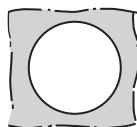
Dome head



d		SS	L	L ₂	Tipo	Codice		
mm	mm	mm	mm	mm	Model	Item code	pz	pz
M5	10.0	0.4 ÷ 4.8	18.0	5.0	JKIA40504810	3271900	250N	3000
M6	12.0	4.8 ÷ 9.5	23.0	5.0	JKIA40609511	3036300	250N	2000
M8	15.0	5.0 ÷ 12.0	25.2	6.0	JKIA40812015	3221600	200P	1000

Consigliato per essere applicato su compensato, plastica, vetroresina, ecc.

Recommended to be applied on plywood, plastic, fiberglass, etc.



Applicazione
Application





Attrezzo per la posa RIV916
Relating tool RIV916
Cod. 4154500

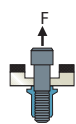

Attrezzo per la posa RIV903C
Relating tool RIV903C
Cod. 3675800



d			Kg	N	Kgm	Nm
mm	mm	mm				
M5	10.0	10.0	60	588	1.6	16
M6	11.0	11.0	80	784	2.2	22
M8	15.0	15.0	100	980	2.8	28

Inserti filettati per materiali soft TUBRIV

TUBRIV rivet nuts for soft materials

TBF

34701



■ Acciaio

Steel

Fusto cilindrico aperto

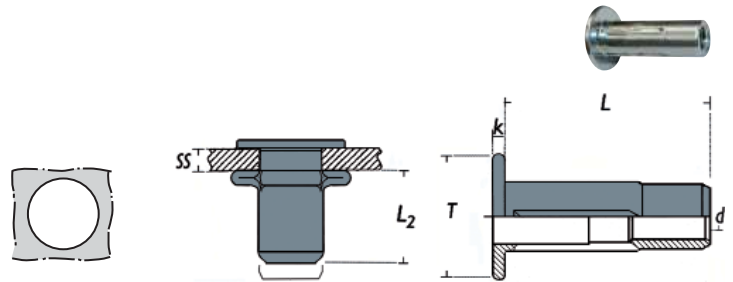
Open cylindrical shank



d		T	k	SS	L	L ₂	Tipo	Codice		
mm	mm	mm	max	mm	mm	mm	Model	Item code	pz	pz
M4	6.15	11.0	0.96	0.5 ÷ 3.80	16.6	8.6	TBF0403806	52155ZB	250S	8000
M5	7.50	12.5	0.96	0.5 ÷ 4.45	22.0	9.9	TBF0504407	37430ZB	250N	4000
M6	9.00	15.5	1.50	0.5 ÷ 7.10	25.0	12.8	TBF0607109	17500ZB	200N	2000
M8	11.50	19.0	1.57	0.5 ÷ 7.10	30.0	14.5	TBF0807111	17498ZB	100N	1000
M10	13.10	22.0	2.24	0.5 ÷ 7.10	31.0	15.8	TBF1007113	52156ZB	100N	1000

Consigliato per essere applicato su compensato, plastica, vetroresina, ecc.

Recommended to be applied on plywood, plastic, fiberglass, etc.



Applicazione
Application





Attrezzo per la posa RIV916
Relating tool RIV916
Cod. 4154500

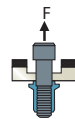

Attrezzo per la posa RIV903C
Relating tool RIV903C
Cod. 3675800



d			Kg	N	Kgm	Nm
mm	mm	mm				
M4	6.15	6.15	700	7000	0.5	5.0
M5	7.50	7.50	1000	10000	0.8	8.0
M6	9.00	9.00	1920	19200	1.2	12.0
M8	11.50	11.50	2540	25400	2.1	21.0
M10	13.10	13.10	3000	30000	3.0	30.0

Inserti maschi RIVBOLT

RIVBOLT male rivet nuts

BFTC

36700

■ **Acciaio**

Steel



Fusto cilindrico

Cylindrical shank

Testa tonda

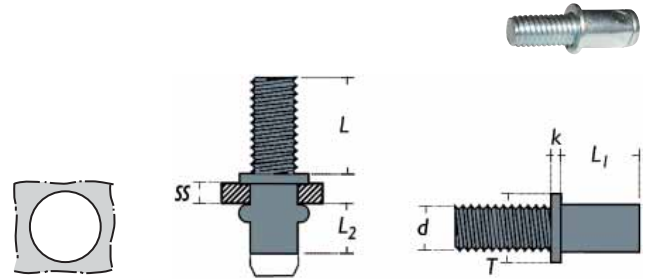
Dome head



d	L		T	k	SS	L ₁	L ₂	Tipo	Codice		
mm	mm	mm	mm	max	mm	mm	mm	Model	Item code	pz	pz
M4	15.0	5.5	8.0	0.5	0.5 ÷ 2.0	8.5	4.0	BFTC1502004	2586100	250S	8000
	15.0				2.0 ÷ 3.0	9.5	BFTC1503004	2586200	250S	8000	
M5	15.0	6.6	9.0	0.8	0.5 ÷ 2.0	10.0	5.0	BFTC1502005	1680000	250S	6000
	15.0				2.0 ÷ 4.8	11.0	BFTC1503805	2586500	250S	4000	
M6	15.0	7.8	10.0	1.0	0.5 ÷ 2.5	11.0	6.0	BFTC1502506	1680100	250S	4000
	15.0				2.5 ÷ 4.0	12.5	BFTC1504006	2586800	250S	4000	
M8	20.0	9.9	12.0	1.0	1.0 ÷ 3.0	14.0	8.0	BFTC2003008	2587100	250N	2000
	20.0				3.0 ÷ 5.0	16.0	BFTC2005008	2587200	250N	2000	

BFTE

36700

■ **Acciaio**

Steel



Fusto esagonale

Hexagonal shank

Testa tonda

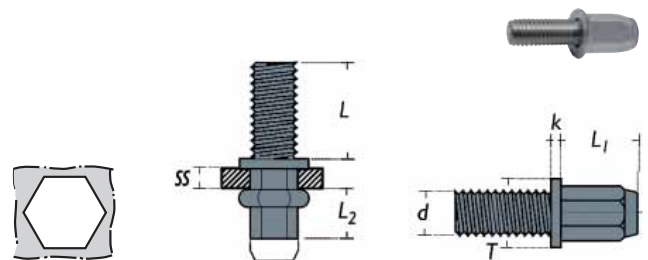
Dome head





d	L		T	k	SS	L ₁	L ₂	Tipo	Codice		
mm	mm	mm	mm	max	mm	mm	mm	Model	Item code	pz	pz
M5	15.0	6.9	10.0	1.0	0.5 ÷ 3.0	11.0	6.0	BFTE1503005	5159300	-	-
M6	15.0	8.9	13.0	1.5	0.5 ÷ 3.0	13.0	8.0	BFTE1503006	5159200	-	-
M8	20.0	10.9	16.0	1.5	0.5 ÷ 3.0	14.0	9.0	BFTE2003008	5159400	-	-



L'inserto prigioniero maschio si utilizza quando si ha la necessità di creare un perno filettato per avvitare un dado.
Male rivet nut is used when you have the need to create a threaded bolt to screw a nut.

Applicazione
Application



d			Kg	N	Kgm	Nm
mm	mm	mm				
M4	5.5		408	4000	0.4	4
M5	6.6	6.9	714	7000	0.7	7
M6	7.8	8.9	1019	10000	1.0	10
M8	9.9	10.9	2854	28000	3.0	30

Inserti maschi RIVBOLT

RIVBOLT male rivet nuts

BITC-Z/A2

36700

■ Acciaio inox A2

A2 stainless steel

Fusto cilindrico zigrinato

Knurled cylindrical shank

Testa tonda

Dome head

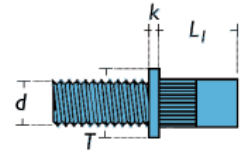
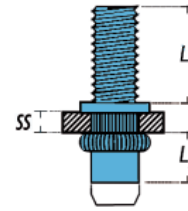

d	L		T	k	SS	L ₁	L ₂	Tipo	Codice		
mm	mm	mm	mm	max	mm	mm	mm	Model	Item code	pz	pz
M6	15.0	9.0	12.3	1.3	0.5 ÷ 3.0	15.7	9-11	BITCZA21503006	5060500	250N	2000
M8	20.0	11.0	14.5	1.5	1.0 ÷ 3.5	18.5	11-13	BITCZA22003508	5060600	250N	2000

BITEP/A2

36700

■ Acciaio inox A2

A2 stainless steel

Fusto semiesagonale

Semi-hexagonal shank

Testa tonda

Dome head

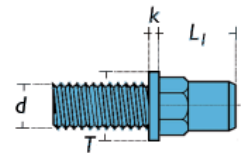
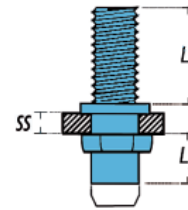

d	L		T	k	SS	L ₁	L ₂	Tipo	Codice		
mm	mm	mm	mm	max	mm	mm	mm	Model	Item code	pz	pz
M6	15.0	9.0	12.7	1.3	0.5 ÷ 3.0	15.7	9-11	BITEPA21503006	5054600	250N	4000
M8	20.0	11.0	16.0	1.5	1.0 ÷ 3.5	18.0	10-12	BITEPA22003508	5054700	250N	4000

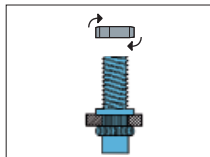

L'inserto prigioniero maschio si utilizza quando si ha la necessità di creare un perno filettato per avvitare un dado.
Male rivet nut is used when you have the need to create a threaded bolt to screw a nut.

Applicazione
Application



d				Kg	N	Kgm	Nm
mm			mm				
M6			9.0	1019	10000	1.5	15
M8			11.0	2854	28000	3.5	35

Inserti distanziali DISERT

DISERT spacer rivet nuts

FTCD

34090

■ Acciaio

Steel



Fusto cilindrico

Cylindrical shank

Testa tonda distanziale

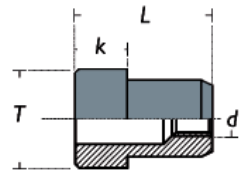
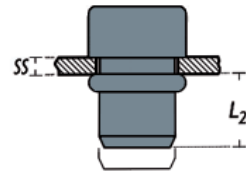
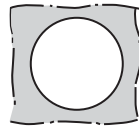
Dome spacing head



d		T	k	SS	L	L ₂	Tipo	Codice		
mm	mm	mm	max	mm	mm	mm	Model	Item code	pz	pz
M3	5.0	8.0	8.0	0.5 ÷ 2.0	16.7	6.0	FTCD0302005	-	-	-
				2.0 ÷ 3.5	18.2		FTCD0303505	-	-	-
M4	6.0	9.0	8.0	0.5 ÷ 2.0	17.7	6.5	FTCD0402006	4616500	-	-
				2.0 ÷ 4.0	19.7		FTCD0404006	-	-	-
M5	7.0	10.0	8.0	0.5 ÷ 2.5	19.5	7.0	FTCD0502507	-	-	-
				2.5 ÷ 4.5	21.5		FTCD0504507	-	-	-
M6	9.0	12.0	8.0	0.5 ÷ 3.0	22.8	9.5	FTCD0603009	-	-	-
				3.0 ÷ 5.5	25.3		FTCD0605509	-	-	-
M8	11.0	14.0	8.0	0.5 ÷ 3.5	23.7	9.5	FTCD0803511	-	-	-
				3.5 ÷ 6.0	26.2		FTCD0806011	-	-	-
M10	13.0	16.0	8.0	0.5 ÷ 3.5	27.5	12.5	FTCD1003513	-	-	-
				3.5 ÷ 6.0	30.0		FTCD1006013	-	-	-



Applicazione

Application

Inserti filettati antivibranti PRENSERT

PRENSERT anti-chatter rivet nuts

NPTC

34800

■ Neoprene

Neoprene



■ Inserto filettato in ottone

Brass rivet nut

Testa tonda

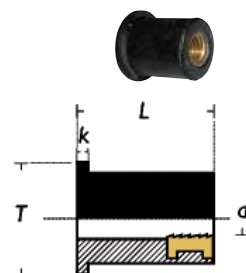
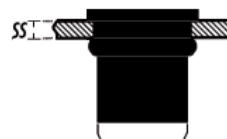
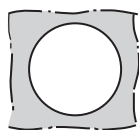
Dome head



d		T	k	SS	L	Tipo	Codice		
mm	mm	mm	max	mm	mm	Model	Item code	pz	pz
M3	8.0 ÷ 8.3	11.0	1.4	0.4 ÷ 4.0	12.6	NPTC0304008	2394400	250S	5000
M4	8.0 ÷ 8.3	11.0	1.4	0.4 ÷ 4.0	12.6	NPTC0404008	2394500	250S	5000
M5	9.7 ÷ 9.9	12.7	0.9	0.4 ÷ 4.9	14.1	NPTC0504910	2394600	250S	5000
	9.7 ÷ 9.9	14.0	0.9	4.0 ÷ 11.6	21.5	NPTC0511610	2394700	250N	2000
M6	9.7 ÷ 9.9	14.0	1.3	7.9 ÷ 16.0	26.1	NPTC0516010	2394800	250P	1500
	9.7 ÷ 9.9	14.0	1.3	20.5 ÷ 30.0	39.8	NPTC0530010	2394900	250P	1000
	12.8 ÷ 13.0	16.0	1.3	0.4 ÷ 2.8	16.0	NPTC0602813	2395000	250N	2000
	12.8 ÷ 13.0	19.1	4.75	0.8 ÷ 4.7	21.1	NPTC0604713	2395200	200P	1000
M8	12.8 ÷ 13.0	16.3	2.0	6.4 ÷ 11.5	26.7	NPTC0611513	2395300	200P	1000
	13.1 ÷ 13.3	16.0	1.3	11.5 ÷ 23.0	35.0	NPTC0623013	2395400	100N	800
	16.0 ÷ 16.2	22.1	3.2	0.4 ÷ 4.0	18.3	NPTC0804016	2395500	100N	1000
M10	16.0 ÷ 16.2	22.1	5.72	3.9 ÷ 9.5	27.9	NPTC0809516	2395600	100P	800
	18.1 ÷ 18.3	20.0	1.6	15.0 ÷ 39.0	50.0	NPTC0839018	2395700	50N	500
M12	20.1 ÷ 20.3	22.5	1.3	19.0 ÷ 40.0	55.0	NPTC1040020	2395800	50P	200
	24.1 ÷ 24.3	27.0	1.3	38.0 ÷ 64.0	80.0	NPTC1264024	2395900	25P	100





Applicazione

Application

Consigliato per eliminare problematiche di rumori che derivano dalle vibrazioni.

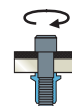
Recommended to avoid problems of noise or on parts subject to vibration.



d			Durezza	Kgm	Nm
mm	mm	mm	Hardness		
M3	8.0 ÷ 8.3		60	0.25-0.50	2.5-5.0
M4	8.0 ÷ 8.3		70	0.25-0.40	2.5-4.0
M5	9.7 ÷ 9.9		60	0.35-0.50	3.5-5.0
	9.7 ÷ 9.9		60	0.30-0.89	3.0-8.9
M6	9.7 ÷ 9.9		60	0.30-0.69	3.0-6.9
	9.7 ÷ 9.9		60	0.59-0.99	5.9-9.9
	12.8 ÷ 13.0		60	0.59-0.99	5.9-9.9
	12.8 ÷ 13.0		70	0.79-0.99	7.9-9.9
M8	12.8 ÷ 13.0		70	0.79-0.99	7.9-9.9
	13.1 ÷ 13.3		70	0.79-0.99	7.9-9.9
	16.0 ÷ 16.2		60	0.99-1.48	9.9-14.8
M10	16.0 ÷ 16.2		60	0.99-1.57	9.9-15.7
	18.1 ÷ 18.3		60	0.99-1.57	9.9-15.7
M12	20.1 ÷ 20.3		60	4.40-5.40	44.0-54.0
	24.1 ÷ 24.3		60	5.90-6.90	59.0-69.0

Inserti filettati in nylon NYLONSERT

NYLONSERT nylon rivet nuts

NBRC

34810

Nylon

Nylon

Inserto filettato in alluminio

Aluminium rivet nut

Testa tonda

Dome head

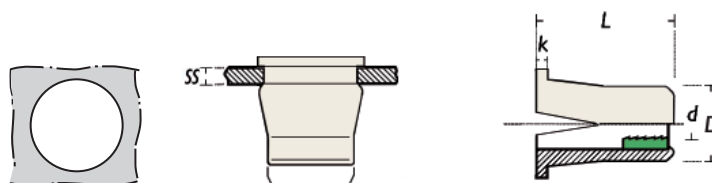

d		D	k	SS	L	Tipo	Codice		
mm	+0.15/-0	mm	max	mm	mm	Model	Item code	pz	pz
M2.5	6.40	6.35	0.75	0.8 ÷ 1.2	8.0	NBRC0251206	5095700	1000S	-
M3	8.00	7.95	0.75	1.3 ÷ 2.0	9.6	NBRC0302008	5095800	1000S	-
M4	10.35	10.30	0.75	2.1 ÷ 2.4	12.7	NBRC0402410	5095900	1000N	-
M5	10.35	10.30	0.75	2.1 ÷ 2.4	12.7	NBRC0502410	5096000	1000N	-
M6	12.70	12.65	0.75	2.5 ÷ 3.2	15.9	NBRC0603212	5096100	500N	-
M8	14.30	14.25	0.75	3.3 ÷ 4.0	19.0	NBRC0804014	5096200	250N	-



Applicazione
Application



Preparare un foro del diametro corretto.
Make a hole of the recommended size.

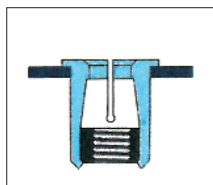

Spingere l'inserto dentro al foro.
Press the fastener into the hole.



Avvitare la vite fino a che non si incontra resistenza o fino ai limiti di torsione indicati.
Drive the screw until solid resistance is felt, or up to recommended torque limits.



Avvitare finché il componente non è fisso.
Screw until the component does not turn.

NYLONSERT è composto da una dado in lega di alluminio allocato in una gabbia dalle pareti affusolate in nylon, e va inserito a pressione dentro un foro.

Vantaggi:

Non necessita di utensili speciali per l'installazione | La tensione nel nylon assicura fermamente l'inserto | Può essere usato su metallo, fibra di vetro, plastica e pannelli | Gabbia di nylon e dado in alluminio danno resistenza alla corrosione e rendono l'assemblaggio a prova di vibrazione | Può essere riusato dopo aver rimosso la vite e pressato il dado fino a riportarlo alla posizione originale.

NYLONSERT consist of a knurled aluminum alloy nut housed in tapered-wall nylon cage which can be insert with finger press into a hole.

Benefits:

No special installation tool is needed | Spring tension of nylon cage secures firmly the rivet nut | It can be used in metal, fiberglass, plastic and hardboard panels | Nylon cage and aluminium nut provide corrosion resistance and make assembly rattle-proof and dampen vibration | It can be re-used after removing the screw and punching the rivet nut to the original position.



d		Lunghezza minima vite suggerita	Kgm	Nm
mm	mm	Minimum recommended screw length		
M2.5	6.4	8.0 + SS	0.17	1.69
M3	8.0	9.6 + SS	0.23-0.34	2.3-3.4
M4	10.35	12.7 + SS	0.23-0.56	2.3-5.6
M5	10.35	12.7 + SS	0.23-0.56	2.3-5.6
M6	12.7	15.9 + SS	0.34-1.13	3.4-11.3
M8	14.3	19.0 + SS	0.45-1.13	4.5-11.3

Tipo	Codice
Model	Item code
PIARIV01	3184900

Assortimento di rivetti, inserti, autoagganciati, bulloni a strappo applicati su piastra in lamiera.
Assortment of blind rivets, rivet nuts, self clinching, blind bolts applied on metal plate.



Vista Fronte.
Front view.



Vista Retro.
Back view.

- | | | | | |
|---|---|--|---|--|
| 1. Rivetto standard
Standard blind rivet | 12. Bullone RIVLOCK ø 8.0
RIVLOCK blind bolt ø 8.0 | 23. Rivetto stagno TL
Sealed blind rivet LH | 34. Insetto NYLONSERT
NYLONSERT rivet nut | 45. Dado autoagg. RKA
RKA self clinching nut |
| 2. Rivetto stagno
Sealed blind rivet | 13. Dado gabbia a pressione
Pressure caged nut | 24. Rivetto LOCKRIV ø 7.8
LOCKRIV blind rivet ø 7.8 | 35. Insetto TRISERT
TRISERT rivet nut | 46. Insetto RIVBOLT
RIVBOLT rivet nut |
| 3. Rivetto MULTIGRIPRIV
MULTIGRIPRIV blind rivet | 14. Rivetto MASRIV2/90R
MASRIV2/90R blind rivet | 25. Insetto FTC
FTC rivet nut | 36. Insetto FTC M12
FTC M12 rivet nut | 47. Insetto PRENSERT M5
PRENSERT M5 rivet nut |
| 4. Rivetto FIORIV
FIORIV blind rivet | 15. Rivetto MASRIV1/90S
MASRIV1/90S blind rivet | 26. Insetto FRC
FRC rivet nut | 37. Insetto FTC M16
FTC M16 rivet nut | 48. Insetto PRENSERT M8
PRENSERT M8 rivet nut |
| 5. Rivetto TRERIV
TRERIV blind rivet | 16. Rivetto MASRIV2/90S
MASRIV2/90S blind rivet | 27. Insetto FTC-Z
FTC-Z rivet nut | 38. Dado gabbia inox
S/steel caged nut | 49. Distanziale aperto autoagg.
Open standoff self clinching |
| 6. Rivetto LOCKRIV
LOCKRIV blind rivet | 17. Rivetto MASRIV4/90S
MASRIV4/90S blind rivet | 28. Insetto FREP
FREP rivet nut | 39. Dado gabbia ferro
Steel caged nut | 50. Distanziale chiuso autoagg.
Blind standoff self clinching |
| 7. Rivetto MAGNARIV ø 6.4
MAGNARIV blind rivet ø 6.4 | 18. Rivetto GTRERIV
GTRERIV blind rivet | 29. Insetto FTE
FTE rivet nut | 40. Dado gabbia ferro
Steel caged nut | 51. Rivetto FILRIV M5
FILRIV M5 blind rivet |
| 8. Rivetto MONRIV ø 6.4
MONRIV blind rivet ø 6.4 | 19. Rivetto TRIPLASTRIV
TRIPLASTRIV blind rivet | 30. Insetto SITC
SITC rivet nut | 41. Dado gabbia ferro
Steel caged nut | 52. Rivetto FILRIV M6
FILRIV M6 blind rivet |
| 9. Rivetto MAGNARIV ø 4.8
MAGNARIV blind rivet ø 4.8 | 20. Rivetto RIVBU
RIVBU blind rivet | 31. Insetto SQUARIV
SQUARIV rivet nut | 42. Dado gabbia alette
Fin caged nut | |
| 10. Rivetto a martello
Drive blind rivet | 21. Rivetto RIVINOX
RIVINOX blind rivet | 32. Insetto JACKRIV
JACKRIV rivet nut | 43. Perno autoagg. RFH
RFH self clinching stud | |
| 11. Bullone RIVLOCK ø 6.4
RIVLOCK blind bolt ø 6.4 | 22. Rivetto MULTIRIV TL
MULTIRIV blind rivet LH | 33. Insetto TUBRIV
TUBRIV rivet nut | 44. Dado autoagg. RS
RS self clinching nut | |

Rondelle per dimostrazione

Washers for demonstration

RONDRIV

990MA

Rondelle tonde Ø 30 per rivetti

Round washers Ø 30 for blind rivets

Tipo	Rivetto Ø Blind rivet Ø	Codice Item code	 pz
RIVIT34	3.2-3.4	5132200	250N
RIVIT40	3.9-4.0	4297400	250N
RIVIT48	4.8	4297700	250N
RIVIT60	*5.9	5132300	250N
RIVIT64	**6.0-6.3-6.4	4113800	250N
RIVIT70	6.4-6.5-6.8	4880100	250N
RIVIT78	7.7-7.8	4833100	250N
RIVIT98	9.8	4113900	250N

* Ø 5.0 FAFT e CAPAF, Ø 5.2 GTAAT e BTAAET, Ø 4.0 MASRIV

** Ø 6.3 GTAAT e BTAAET, Ø 6.4 AFT, AFL, FFT, IITA2, SAFT, SIITA2, OAAT

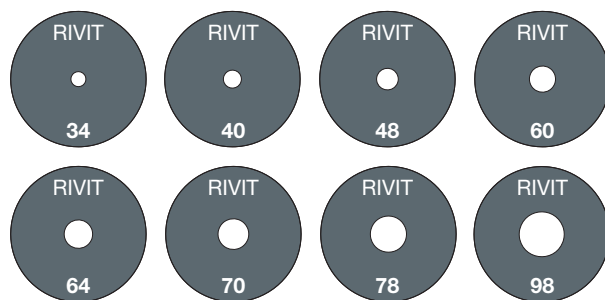

Rondelle tonde Ø 30 per inserti cilindrici

Round washers Ø 30 for cylindrical rivet nuts

Tipo	Inserto Rivet nut	Codice Item code	 pz
RIVIT48	M3	4297700	250N
RIVIT60	M4	5132300	250N
RIVIT64	*M4	4113800	250N
RIVIT70	M5	4880100	250N
RIVIT78	**M3-M4-M6	4833100	250N
RIVIT90	M6-M9	4417700	250N
RIVIT98	***M5-M6-M8	4113900	250N
RIVIT110	****M6-M8-M11	4832500	250N

* M4 FRT e IRC-P/A2

** M3 NPTC, M4 NPTC e JFK, M6 BFTC

*** M5 JFK e JKI/A4, M6 FRC-P, IRC-P/A2, FRT, M8 BFTC

**** M6 JFK, JKI/A4

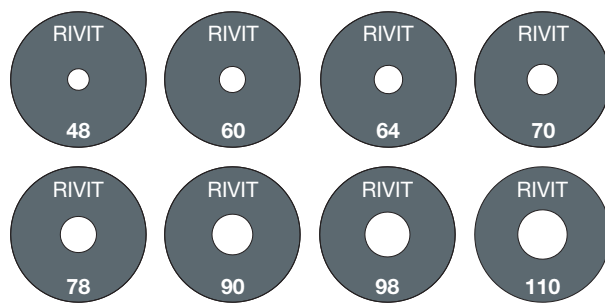

Rondelle tonde Ø 30 per esagonatrice RIV990 M6

Washers round Ø 30 for hexcutter tool RIV990 M6

Tipo	Inserto Rivet nut	Codice Item code	 pz
RIVIT95	M6	4833500	250N

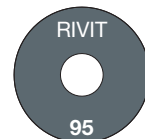

Rondelle tonde Ø 30 per inserti esagonali

Round washers Ø 30 for hexagonal rivet nuts

Tipo	Inserto es. Hex. Rivet nut	Codice Item code	 pz
RIVITE90	M6	4833000	250N
RIVITE110	M8	4832600	250N

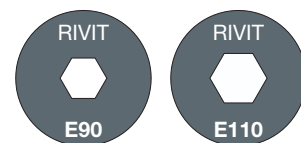

Rondelle quadre 48x48 per rivetti in cartuccia (Bririv)

Square washers 48x48 for speed rivets in cartridge (Bririv)

Tipo	Bririv Ø Bririv Ø	Codice Item code	 pz
RIVIT32	3.2	4832700	100N

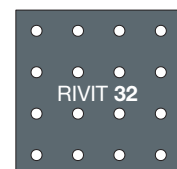

Rondelle rettangolari 60x40 per perni a saldare

Rectangular washers 60x40 for welding studs

Tipo	Perno a sald. Welding stud	Codice Item code	 pz
RIVIT	M3-M8	5132500	100N

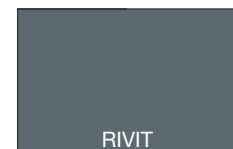



Rivettatrici manuali per inserti

Hand tools for rivet nuts

RIV900

35010

Tipo	Codice	
Model	Item code	gr
RIV900	3676000	910



Rivsert



Ø inserti	Alluminio	Acciaio	Inox	Tiranti codice	Testine codice
Rivet nuts Ø	Aluminium	Steel	Stainless st.	Tie rod code	Head code
M3	●	●	●	3710300	3707200
M4	●	●	●	3710400	3707300
M5	●	●	●	3710500	3707400



RIV901

35010

Tipo	Codice	
Model	Item code	gr
RIV901	3675900	910



Rivsert



Ø inserti	Alluminio	Acciaio	Inox	Tiranti codice	Testine codice
Rivet nuts Ø	Aluminium	Steel	Stainless st.	Tie rod code	Head code
M3	●	●	●	3706800	3707200
M4	●	●	●	3706900	3707300
M5	●	●	●	3707000	3707400
M6	●	●	●	3707100	3707500



RIV903C

35010

Tipo	Codice	
Model	Item code	gr
RIV903C	3675800	2200



Rivsert



Ø inserti	Alluminio	Acciaio	Inox	Tiranti codice	Testine codice
Rivet nuts Ø	Aluminium	Steel	Stainless st.	Tie rod code	Head code
M3	●	●	●	3707600	3708200
M4	●	●	●	3707700	3708300
M5	●	●	●	3707800	3708400
M6	●	●	●	3707900	3708500
M8	●	●	●	3708000	3708600
M10	●	●	●	3708100	3708700



Con tiranti | With tie rods
M3, M4, M5, M6, M8, M10

Ricambi per TUBRIV e JACKRIV

Spare parts for TUBRIV and JACKRIV

Ø inserti	Tiranti codice	Testine codice
Rivet nuts Ø	Tie rod code	Head code
M5	4707300	3708400
M6	4193900	3708500
M8	4194000	3708600



Jackriv



Tubriv

Tipo	Codice	
Model	Item code	gr
RIV98	5126400	535



Rivsert

Ø inserti	Alluminio	Acciaio	Inox	Tiranti codice	Testine codice
Rivet nuts Ø	Aluminium	Steel	Stainless st.	Tie rod code	Head code
M3	●	●	●	5201400	5201800
M4	●	●	●	5201500	5201900
M5	●	●	●	5201600	5202000
M6	●	●	●	5201700	5202100



Rivettatrici manuali per inserti in cassetta

Hand tools for rivet nuts in box

RIV900C

35010

Tipo	Codice	
Model	Item code	gr
RIV900C	3687700	3000



Ø inserti	Alluminio	Acciaio	Inox	Tiranti codice	Testine codice
Rivet nuts Ø	Aluminium	Steel	Stainless st.	Tie rod code	Head code
M3	●	●	●	3710300	3707200
M4	●	●	●	3710400	3707300
M5	●	●	●	3710500	3707400



Con inserti in acciaio:
With steel rivet nuts:
FTC-Z M3, M4, M5 - 100 pz | pcs

RIV901C

35010

Tipo	Codice	
Model	Item code	gr
RIV901C	3687800	3500



Ø inserti	Alluminio	Acciaio	Inox	Tiranti codice	Testine codice
Rivet nuts Ø	Aluminium	Steel	Stainless st.	Tie rod code	Head code
M3	●	●	●	3706800	3707200
M4	●	●	●	3706900	3707300
M5	●	●	●	3707000	3707400
M6	●	●	●	3707100	3707500



Con inserti in acciaio:
With steel rivet nuts:
FTC-Z M3, M4, M5, M6 - 100 pz | pcs

RIV901CX

35010

Tipo	Codice	
Model	Item code	gr
RIV901CX	4499500	3500



Ø inserti	Alluminio	Acciaio	Inox	Tiranti codice	Testine codice
Rivet nuts Ø	Aluminium	Steel	Stainless st.	Tie rod code	Head code
M3	●	●	●	3706800	3707200
M4	●	●	●	3706900	3707300
M5	●	●	●	3707000	3707400
M6	●	●	●	3707100	3707500



Con inserti in acciaio inox:
With stainless steel rivet nuts:
ITC-Z M3, M4, M5, M6 - 100 pz | pcs

CASSM

35010

Tipo	Codice	
Model	Item code	gr
CASSM	4316900	540

Cassetta in polipropilene trasparente con divisori mobili.
Transparent polypropylene box with movable dividers.



Rivettatrice ad olio manuale per inserti

Hydraulic hand tool for rivet nuts

RIV905

05002

Tipo	Codice			
Model	Item code	gr		
RIV905	4318900	1611		
Ø inserti	Alluminio	Acciaio	Inox	
Rivet nuts Ø	Aluminium	Steel	Stainless st.	
M3	●	●	●	
M4	●	●	●	
M5	●	●	●	
M6	●	●	●	
M8	●	●	●	
M10	●	●	●	
M12	●	●	●	

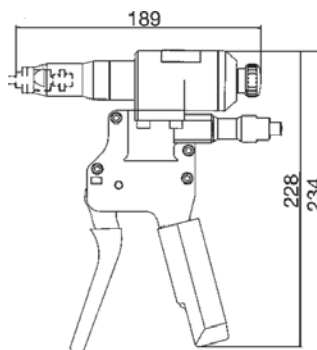

Per inserti filettati femmine RIVSERT da M3 a M12 e inserti filettati maschi RIVBOLT da M4 a M10. To place RIVSERT female rivet nuts from M3 to M12 and RIVBOLT male rivet nuts from M4 to M10.

RIV905, grazie alla sua forza di trazione azionata con olio, può tirare inserti fino a M12. Per non utilizzare più il tirante speciale, è stato progettato un sistema che alloggia una vite a brugola in acciaio classe 12.9, facile da reperire e da sostituire. Due to its high setting force activated with oil, RIV905 is able to place rivet nuts up to M12. In order to avoid the use of a special rod, a system has been projected to lodge an allen screw (hardness class 12.9), easy to find on the market and replace.

Ricambi per RIVSERT

Spare parts for RIVSERT



Ø inserti	Kit	Codice kit	* Cod. vite (DIN912 12.9)
Rivet nuts Ø		Kit code	Screw code (DIN912 12.9)
M3	905/03	3441100	3457600
M4	905/04	3441200	3470500
M5	905/05	3441300	3471900
M6	905/06	3441400	3472300
M8	905/08	3441500	3472800
M10	905/10	3441600	3473100
M12	905/12	3441700	3473300

* La vite è compresa nel "codice kit" e può essere ordinata a parte.
* Screw is included in the "kit code" and can be ordered separately.



Ricambi per RIVBOLT

Spare parts for RIVBOLT



Ø inserti	Kit	Codice kit	* Cod. tirante femmina
Rivet nuts Ø		Kit code	* Female tie rod code
M4	905/04B	3442300	3441900
M5	905/05B	3442400	3442000
M6	905/06B	3442500	3442100
M8	905/08B	3442600	3442200
M10	905/10B	4601900	4601800

* Il tirante femmina è compreso nel "codice kit" e può essere ordinato a parte.
* The female tie rod is included in the "kit code" and can be ordered separately.



Accessori a richiesta

Optional

Descrizione	Codice
Description	Item code
KIT905-Testata speciale prolunga KIT905-Special extended head	3531800



RIV905 viene venduta senza il kit della testata anteriore. In base alla misura dell'inserto che si deve utilizzare, aggiungere all'ordine il kit corrispondente (vedi tabella ricambi RIVSERT/RIVBOLT).

RIV905 is supplied without the frontal head kit. Choose the correct kit according to the size of the rivet nut to be placed, and add it to the order (see the spare parts for RIVSERT/RIVBOLT).

Dati tecnici e caratteristiche

Technical data and features

Corsa	9 mm
Stroke	
Forza di trazione a 6 bar	25000 N
Max power (6 bar)	
Peso (senza kit)	1.611 kg
Weight (without kit)	

Regolazione pressione olio (forza)

Setting oil pressure (force)



Girare il perno posteriore con chiave a brugola da 5 mm in senso orario per aumentare la pressione olio (forza) e in senso antiorario per ridurla.

Turn the pin at the back of the tool with a 5 mm wrench spanner clockwise to increase oil pressure (force) and counterclockwise to reduce it.

Numero giri completi (A)	Forza di trazione
Full turns (A)	Setting force
0	1000N
6	3800N
7	5000N
8	6300N
9	7800N
10	9200N
11	10400N
12	12900N
13	14800N
14	16000N
15	16950N
16	19000N
17	21000N
18	22200N
19	24000N
20	25000N

Rivettatrice manuale a cricchetto per inserti

Ratchet hand tool for rivet nuts

RIV906

05002

Tipo	Codice	
Model	Item code	gr
RIV906	5078000	1.100

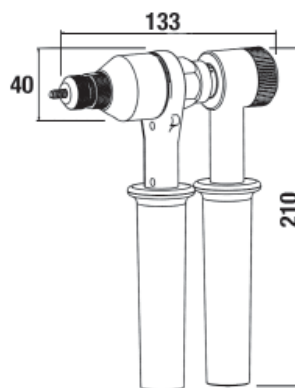

Ø inserti	Alluminio	Acciaio	Inox
Rivet nuts Ø	Aluminium	Steel	Stainless st.
M5	●	●	●
M6	●	●	●
M8	●	●	●
M10	●	●	●
M12	●	●	●

Ø Rivbolt	Acciaio	Inox
Rivbolt Ø	Steel	Stainless st.
M5	●	●
M6	●	●
M8	●	●

RIV906 viene venduta in scatola di cartone completa di tiranti e testine.
RIV906 is supplied in a cardboard box complete with tie rods and heads.

Per inserti filettati femmine RIVSERT da M5 a M12
e inserti filettati maschi RIVBOLT da M5 a M8.
To place RIVSERT female rivet nuts from M5 to M12
and RIVBOLT male rivet nuts from M5 to M8.



RIV906 può tirare inserti fino a M12.
RIV906 can place rivet nuts up to M12.



Ricambi per RIVSERT

Spare parts for RIVSERT



Ø inserti		Cod. tiranti		Cod. testine
Rivet nuts Ø	Tie rod code		Head code	
M5		5078100		5078600
M6		5078200		5078700
M8		5078300		5078800
M10		5078400		5078900
M12		5078500		5079100

Dati tecnici e caratteristiche



Technical data and features

Corsa	0-7 mm
Stroke	0-7 mm
Dimensioni	210 x 133 x 40 mm
Dimensions	210 x 133 x 40 mm
Peso (senza kit)	1.100 kg
Weight (without kit)	1.100 kg

Ricambi per RIVBOLT

Spare parts for RIVBOLT



Ø inserti		Cod. tiranti		Cod. testine
Rivet nuts Ø	Tie rod code		Head code	
M5		5079200		5078600
M6		5079300		5078700
M8		5079400		5078800



Inserire testina e tirante adatti alla misura dell'inserto.
Place the mandrel and the corresponding nosepiece into the tool.



Avvitare l'inserto sul tirante, regolare la ghiera in modo da posizionarlo a filo con la testina.
Screw the rivet nut onto the mandrel, adjust the nosepiece to have it all screwed at the bottom.



Usare la leva superiore come supporto e ruotare la leva inferiore in senso orario.
Use top handle as a support while using the bottom handle to ratchet.



Fissato l'inserto, spostare la levetta sull'altra posizione.
Flip the switch in the opposite direction.



Ruotare la leva inferiore in senso antiorario per sbloccare e poi svitare il tirante ruotando il pomello.
Push the lower handle counterclockwise once and then simply undo the bolt.

Rivettatrice manuale per inserti JACKRIV

Hand tool for JACKRIV rivet nuts

RIV918

05002

Tipo	Codice	
Model	Item code	gr
RIV918	4293200	540



Ø inserti	Acciaio	Inox
Rivet nuts Ø	Steel	S/Steel
M4	●	●
M5	●	●
M6	●	
M8	●	



Jackriv



Per JACKRIV
For JACKRIV rivet nuts

In cassetta con JACKRIV in acciaio

In a box with steel JACKRIV

RIV918C

05002

Tipo	Codice	
Model	Item code	gr
RIV918C	4333600	680

Contenuto cassetta

Case content

Inserti in acciaio JACKRIV M4, M5, M6 - 100 pz

Inserti in acciaio JACKRIV M8 - 50 pz

M4, M5, M6 JACKRIV steel rivet nuts - 100 pcs

M8 JACKRIV steel rivet nuts - 50 pcs

Vite M4 x 25 - 1 pz | M4 x 25 screw - 1 pc

Vite M5 x 25 - 1 pz | M5 x 25 screw - 1 pc

Vite M6 x 25 - 1 pz | M6 x 25 screw - 1 pc

Vite M8 x 35 - 1 pz | M8 x 35 screw - 1 pc



In cassetta con JACKRIV in acciaio inox

In a box with stainless steel JACKRIV

RIV918CX

05002

Tipo	Codice	
Model	Item code	gr
RIV918CX	4581300	620

Contenuto cassetta

Case content

Inserti in acciaio inox JACKRIV M5, M6 - 100 pz

Inserti in acciaio inox JACKRIV M8 - 50 pz

M5, M6 JACKRIV stainless steel rivet nuts - 100 pcs

M8 JACKRIV stainless steel rivet nuts - 50 pcs

Vite M5 x 25 - 1 pz | M5 x 25 screw - 1 pc

Vite M6 x 25 - 1 pz | M6 x 25 screw - 1 pc

Vite M8 x 35 - 1 pz | M8 x 35 screw - 1 pc



La rivettatrice per inserti RIV918 è venduta sia singolarmente che in cassetta (con inserti e viti).
RIV918 for rivet nuts is supplied both individually or in case (with rivet nuts and screws).

Rivettatrice oleopneumatica per inserti (2 fasi)

Hydropneumatic tool for rivet nuts (2 phases)

RIV998

35002

Tipo	Codice
Model	Item code
RIV998	2237000

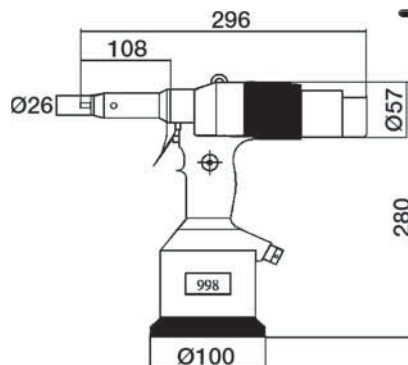

Per inserti filettati femmine RIVSERT da M3 a M12 in alluminio e acciaio (inox fino a M10) e inserti filettati maschi RIVBOLT da M4 a M8.

To place RIVSERT female rivet nuts in aluminium and steel from M3 to M12 (s/steel up to M10) and RIVBOLT male rivet nuts, from M4 to M8.

RIV998 per applicare inserti utilizzando la regolazione della corsa.

Avvitamento automatico posizionando il tirante sull'inserto,

1 FASE deformazione inserto - 2 FASE svitamento inserto.

Il sistema oleopneumatico e le parti meccaniche che compongono la struttura interna dell'utensile, rispetto ad altri modelli di tirainseriti, danno un'ottima affidabilità.

Caratteristica della RIV998 è la riduzione dei problemi dovuti all'usura dei componenti con il conseguente aumento della durata e della funzionalità.

Le soluzioni tecniche adottate riducono le dimensioni e il peso della macchina, rendendo la RIV998 assolutamente maneggevole.

RIV998 to place rivet nuts using stroke adjustment.

Automatic screwing by positioning the tie rod in the rivet nut,

1 PHASE rivet nut deformation - 2 PHASE rivet nut unscrewing.

The hydropneumatic system and the mechanical components used in the inside structure of the tool, when compared with other models, result to be much more reliable.

A tool feature is a reduction of the problems caused by the wear and tear of the components, and consequently, the tool will last much longer and work better.

The technical solutions adopted reduce the dimensions and the weight of the RIV998, which results to be a very handy tool.



RIV998 viene venduta in cassetta completa di tiranti speciali e testine da M3 a M10 (M12 su richiesta).

RIV998 is supplied in a case complete with special tie rods and heads from M3 to M10 (M12 on request).

Ricambi per RIVSERT

Spare parts for RIVSERT



Ø inserti	Cod. tiranti	Cod. testine
Rivet nuts Ø	Tie rod code	Head code
M3	0327800	0328500
M4	0327900	0328600
M5	0328000	0328700
M6	0328100	0328800
M8	0328200	0328900
M10	0328300	0329000
*M12	0328400	0329100

* Non inclusi nella fornitura standard. Da ordinare a parte.

* Not included in the standard supply. To be ordered separately.

Ricambi per RIVBOLT

Spare parts for RIVBOLT



Ø inserti	Cod. tiranti	Cod. testine
Rivet nuts Ø	Tie rod code	Head code
M4	2560900	2561200
M5	2561000	2561300
M6	2561100	2561400
M8	2583200	2700500

Accessori a richiesta

Optional

Descrizione	Codice
Description	Item code
KIT998-Testata speciale prolunga KIT998-Special extended head	3531800



Dati tecnici e caratteristiche

Technical data and features

Pressione aria esercizio Air working pressure	6 bar
Pressione aria min-max Min-max air pressure	5/7 bar
Consumo aria per ciclo 6 bar Air consumption per cycle (6 bar)	7.5 lt
Corsa Stroke	0/6.5 mm
Forza di trazione a 6 bar Max power (6 bar)	19000 N
Peso (senza kit) Weight (without kit)	2.405 kg
Vibrazioni Vibrations	< 2,5 m/s ²
Rumorosità Noise level	< 70 dB (A)

Rivettatrice oleopneumatica per inserti (1 fase)

Hydropneumatic tool for rivet nuts (1 phase)

RIV912

35002

Tipo	Codice
Model	Item code
RIV912	3440900

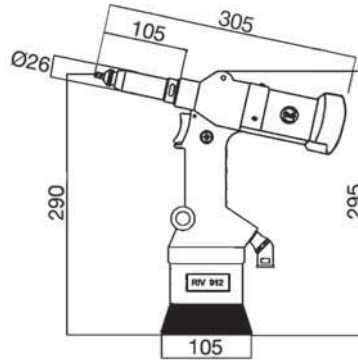

Per inserti filettati femmine RIVSERT da M3 a M12 e inserti filettati maschi RIVBOLT da M4 a M10.

To place RIVSERT female rivet nuts from M3 to M12 and RIVBOLT male rivet nuts from M4 to M10.

RIV912 per applicare inserti utilizzando la regolazione della corsa. Avvitamento automatico posizionando il tirante sull'inserto, 1 FASE deformazione e svitamento inserto.

Per non utilizzare più il tirante speciale, è stato progettato un sistema che alloggia una vite a brugola in acciaio classe 12.9, facile da reperire e da sostituire.

RIV912 to place rivet nuts using stroke adjustment.

Automatic screwing by positioning the tie rod in the rivet nut, 1 PHASE rivet nut deformation and unscrewing.

In order to avoid the use of a special rod, a system has been projected to lodge an allen screw (hardness class 12.9), easy to find on the market and replace.



RIV912 viene venduta in cassetta senza il kit della testata anteriore. In base alla misura dell'inserto che si deve utilizzare, aggiungere all'ordine il kit corrispondente (vedi tabella ricambi RIVSERT/RIVBOLT). RIV912 is supplied in a case without the frontal head kit. Choose the correct kit according to the size of the rivet nut to be placed, and add it to the order (see the spare parts for RIVSERT/RIVBOLT).

Ricambi per RIVSERT

Spare parts for RIVSERT



Ø inserti	Kit	Codice kit	* Cod. vite (DIN912 12.9)
Rivet nuts Ø		Kit code	* Screw code (DIN912 12.9)
M3	912/03	3441100	3457600
M4	912/04	3441200	3470500
M5	912/05	3441300	3471900
M6	912/06	3441400	3472300
M8	912/08	3441500	3472800
M10	912/10	3441600	3473100
M12	912/12	3441700	3473300

* La vite è compresa nel "codice kit" e può essere ordinata a parte.

* Screw is included in the "kit code" and can be ordered separately.



Ricambi per RIVBOLT

Spare parts for RIVBOLT



Ø inserti	Kit	Codice kit	* Cod. tirante femmina
Rivet nuts Ø		Kit code	* Female tie rod code
M4	912/04B	3442300	3441900
M5	912/05B	3442400	3442000
M6	912/06B	3442500	3442100
M8	912/08B	3442600	3442200
M10	912/10B	4601900	4601800

* Il tirante femmina è compreso nel "codice kit" e può essere ordinato a parte.

* The female tie rod is included in the "kit code" and can be ordered separately.



Accessori a richiesta

Optional

Descrizione	Codice
Description	Item code
KIT912-Testata speciale prolunga KIT912-Special extended head	3531800



Dati tecnici e caratteristiche

Technical data and features

Pressione aria esercizio Air working pressure	6 bar
Pressione aria min-max Min-max air pressure	5/6 bar
Consumo aria per ciclo 6 bar Air consumption per cycle (6 bar)	7.5 lt
Corsa Stroke	1/6.5 mm
Forza di trazione a 6 bar Max power (6 bar)	22500 N
Peso (senza kit) Weight (without kit)	2.501 kg
Vibrazioni Vibrations	< 2,5 m/s ²
Rumorosità Noise level	78.5 dB (A)

RIV912MS



Cod. 4307400 - Versione rotazione SX
Item code 4307400 - Left rotation version

Rivettatrice oleopneumatica con pedaliera per inserti (1 fase)

Pedal hydropneumatic tool for rivet nuts (1 phase)

RIV912CP

35002

Tipo	Codice
Model	Item code
RIV912CP	4262500

Per inserti filettati femmine RIVSERT da M3 a M12 e inserti filettati maschi RIVBOLT da M4 a M10.

To place RIVSERT female rivet nuts from M3 to M12 and RIVBOLT male rivet nuts from M4 to M10.

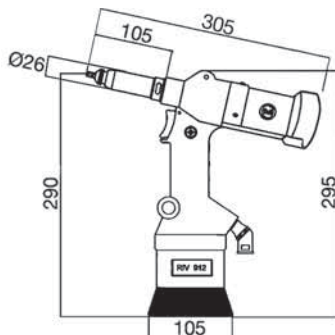

Il pedale è predisposto per ricevere più macchine.
The pedal can operate multiple tools simultaneously.

RIV912CP per applicare inserti utilizzando la regolazione della corsa.
Avvitamento automatico posizionando il tirante sull'inserto,
1 FASE deformazione e svitamento inserto.
Per non utilizzare più il tirante speciale, è stato progettato un sistema che alloggia una vite a brugola in acciaio classe 12.9, facile da reperire e da sostituire.
RIV912CP to place rivet nuts using stroke adjustment.
Automatic screwing by positioning the tie rod in the rivet nut,
1 PHASE rivet nut deformation and unscrewing.
In order to avoid the use of a special rod, a system has been projected to lodge an allen screw (hardness class 12.9), easy to find on the market and replace.

RIV912CP viene venduta senza il kit della testata anteriore.
In base alla misura dell'inserto che si deve utilizzare, aggiungere all'ordine il kit corrispondente (vedi tabella ricambi RIVSERT/RIVBOLT).
RIV912CP is supplied without the frontal head kit.
Choose the correct kit according to the size of the rivet nut to be placed, and add it to the order (see the spare parts for RIVSERT/RIVBOLT).

Ricambi per RIVSERT

Spare parts for RIVSERT



Ø inserti	Kit	Codice kit	* Cod. vite (DIN912 12.9)
Rivet nuts Ø		Kit code	* Screw code (DIN912 12.9)
M3	912/03	3441100	3457600
M4	912/04	3441200	3470500
M5	912/05	3441300	3471900
M6	912/06	3441400	3472300
M8	912/08	3441500	3472800
M10	912/10	3441600	3473100
M12	912/12	3441700	3473300

* La vite è compresa nel "codice kit" e può essere ordinata a parte.
* Screw is included in the "kit code" and can be ordered separately.



Ricambi per RIVBOLT

Spare parts for RIVBOLT



Ø inserti	Kit	Codice kit	* Cod. tirante femmina
Rivet nuts Ø		Kit code	* Female tie rod code
M4	912/04B	3442300	3441900
M5	912/05B	3442400	3442000
M6	912/06B	3442500	3442100
M8	912/08B	3442600	3442200
M10	912/10B	4601900	4601800

* Il tirante femmina è compreso nel "codice kit" e può essere ordinato a parte.
* The female tie rod is included in the "kit code" and can be ordered separately.



Accessori a richiesta

Optional

Descrizione	Codice
Description	Item code
KIT912-Testata speciale prolunga KIT912-Special extended head	3531800

Dati tecnici e caratteristiche

Technical data and features

Pressione aria esercizio Air working pressure	6 bar
Pressione aria min-max Min-max air pressure	5/6 bar
Consumo aria per ciclo 6 bar Air consumption per cycle (6 bar)	7.5 lt
Corsa Stroke	1/6.5 mm
Forza di trazione a 6 bar Max power (6 bar)	22500 N
Peso (senza kit) Weight (without kit)	2.501 kg
Vibrazioni Vibrations	< 2,5 m/s ²
Rumorosità Noise level	78.5 dB (A)



Rivettatrice oleopneumatica per inserti (1 fase)

Hydropneumatic tool for rivet nuts (1 phase)

RIV938

35002

Tipo	Codice
Model	Item code
RIV938	4143400

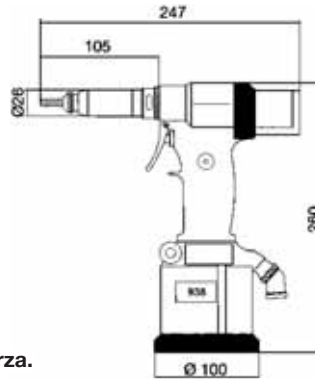

Per inserti filettati femmine RIVSERT da M3 a M10 e inserti filettati maschi RIVBOLT da M4 a M10.

To place RIVSERT female rivet nuts from M3 to M10 and RIVBOLT male rivet nuts from M4 to M10.

RIV938 per applicare inserti utilizzando la regolazione della forza. Avvitamento automatico posizionando il tirante sull'inserto, 1 FASE deformazione e svitamento inserto.

Per non utilizzare più il tirante speciale, è stato progettato un sistema che alloggia una vite a brugola in acciaio classe 12.9, facile da reperire e da sostituire.

Vantaggi: montaggio kit senza uso della chiave | non occorre nessuna regolazione al variare dello spessore | nessun danno alla vite se l'operazione di deformazione dell'inserto viene ripetuta.

RIV938 to place rivet nuts using force adjustment.

Automatic screwing by positioning the tie rod in the rivet nut, 1 PHASE rivet nut deformation and unscrewing.

In order to avoid the use of a special rod, a system has been projected to lodge an allen screw (hardness class 12.9), easy to find on the market and replace.

Advantages: kit assembling without use of the key | does not require any regulation to the vary of the thickness | no damage to the screw if the operation of deformation of the rivet nut is repeated.

Ricambi per RIVSERT

Spare parts for RIVSERT



Ø inserti	Kit	Codice kit	* Cod. vite (DIN912 12.9)
Rivet nuts Ø		Kit code	* Screw code (DIN912 12.9)
M3	938/03	3441100	3457600
M4	938/04	3441200	3470500
M5	938/05	3441300	3471900
M6	938/06	3441400	3472300
M8	938/08	3441500	3472800
M10	938/10	3441600	3473100

* La vite è compresa nel "codice kit" e può essere ordinata a parte.

* Screw is included in the "kit code" and can be ordered separately.

Ricambi per RIVBOLT

Spare parts for RIVBOLT



Ø inserti	Kit	Codice kit	* Cod. tirante femmina
Rivet nuts Ø		Kit code	* Female tie rod code
M4	938/04B	3442300	3441900
M5	938/05B	3442400	3442000
M6	938/06B	3442500	3442100
M8	938/08B	3442600	3442200
M10	938/10B	4601900	4601800

* Il tirante femmina è compreso nel "codice kit" e può essere ordinato a parte.

* The female tie rod is included in the "kit code" and can be ordered separately.

Accessori a richiesta

Optional

Descrizione	Codice
Description	Item code
KIT938-Testata speciale prolunga	3531800
KIT938-Special extended head	
Protezione alare antigraffio	4217600
Anti-scratch wing protection	

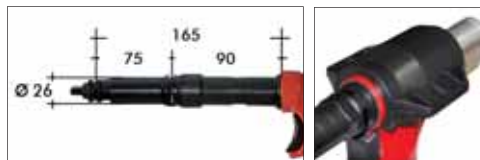

RIV938 viene venduta in cassetta senza il kit della testata anteriore. In base alla misura dell'inserto che si deve utilizzare, aggiungere all'ordine il kit corrispondente (vedi tabella ricambi RIVSERT/RIVBOLT).

RIV938 is supplied in a case without the frontal head kit. Choose the correct kit according to the size of the rivet nut to be placed, and add it to the order (see the spare parts for RIVSERT/RIVBOLT).

Dati tecnici e caratteristiche

Technical data and features

Pressione aria esercizio	6 bar
Air working pressure	
Pressione aria min-max	5/7 bar
Min-max air pressure	
Consumo aria per ciclo 6 bar	5 lt
Air consumption per cycle (6 bar)	
Corsa	6.5 mm
Stroke	
Forza di trazione a 6 bar	20000 N
Max power (6 bar)	
Peso (senza kit)	2.041 kg
Weight (without kit)	
Vibrazioni	< 2,5 m/s ²
Vibrations	
Rumorosità	76 dB (A)
Noise level	



Regolazione della forza
Force adjustment

Rivettatrice oleopneumatica con pedaliera per inserti (1 fase)

Pedal hydropneumatic tool for rivet nuts (1 phase)

RIV938CP

35002

Tipo	Codice
Model	Item code
RIV938CP	4262400

Per inserti filettati femmine RIVSERT da M3 a M10 e inserti filettati maschi RIVBOLT da M4 a M10.

To place RIVSERT female rivet nuts from M3 to M10 and RIVBOLT male rivet nuts from M4 to M10.

Il pedale è predisposto per ricevere più macchine.
The pedal can operate multiple tools simultaneously.

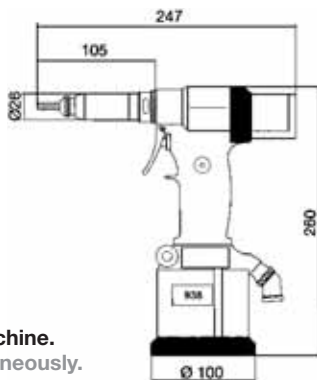

RIV938CP per applicare inserti utilizzando la regolazione della forza.

Avvitamento automatico posizionando il tirante sull'inserto,

1 FASE deformazione e svitamento inserto.

Per non utilizzare più il tirante speciale, è stato progettato un sistema che alloggia una vite a brugola in acciaio classe 12.9, facile da reperire e da sostituire.

Vantaggi: montaggio kit senza uso della chiave | non occorre nessuna regolazione al variare dello spessore | nessun danno alla vite se l'operazione di deformazione dell'inserto viene ripetuta.

RIV938CP to place rivet nuts using force adjustment.

Automatic screwing by positioning the tie rod in the rivet nut,

1 PHASE rivet nut deformation and unscrewing.

In order to avoid the use of a special rod, a system has been projected to lodge an allen screw (hardness class 12.9), easy to find on the market and replace.

Advantages: kit assembling without use of the key | does not require any regulation to the vary of the thickness | no damage to the screw if the operation of deformation of the rivet nut is repeated.

Ricambi per RIVSERT

Spare parts for RIVSERT



Ø inserti	Kit	Codice kit	* Cod. vite (DIN912 12.9)
Rivet nuts Ø		Kit code	* Screw code (DIN912 12.9)
M3	938/03	3441100	3457600
M4	938/04	3441200	3470500
M5	938/05	3441300	3471900
M6	938/06	3441400	3472300
M8	938/08	3441500	3472800
M10	938/10	3441600	3473100

* La vite è compresa nel "codice kit" e può essere ordinata a parte.

* Screw is included in the "kit code" and can be ordered separately.

Ricambi per RIVBOLT

Spare parts for RIVBOLT



Ø inserti	Kit	Codice kit	* Cod. tirante femmina
Rivet nuts Ø		Kit code	* Female tie rod code
M4	938/04B	3442300	3441900
M5	938/05B	3442400	3442000
M6	938/06B	3442500	3442100
M8	938/08B	3442600	3442200
M10	938/10B	4601900	4601800

* Il tirante femmina è compreso nel "codice kit" e può essere ordinato a parte.

* The female tie rod is included in the "kit code" and can be ordered separately.

Accessori a richiesta

Optional

Descrizione	Codice
Description	Item code
KIT938-Testata speciale prolunga KIT938-Special extended head	3531800
Protezione alare antigraffio Anti-scratch wing protection	4217600

RIV938CP viene venduta senza il kit della testata anteriore.

In base alla misura dell'inserto che si deve utilizzare aggiungere all'ordine il kit corrispondente

(vedi tabella ricambi per RIVSERT/RIVBOLT).
RIV938CP is supplied without the frontal head kit.

Choose the correct kit according to the size of the rivet nut to be placed, and add it to the order
(see the spare parts for RIVSERT/RIVBOLT).

Dati tecnici e caratteristiche

Technical data and features

Pressione aria esercizio Air working pressure	6 bar
Pressione aria min-max Min-max air pressure	5/7 bar
Consumo aria per ciclo 6 bar Air consumption per cycle (6 bar)	5 lt
Corsa Stroke	6.5 mm
Forza di trazione a 6 bar Max power (6 bar)	20000 N
Peso (senza kit) Weight (without kit)	2.041 kg
Vibrazioni Vibrations	< 2,5 m/s ²
Rumorosità Noise level	76 dB (A)



Regolazione della forza
Force adjustment

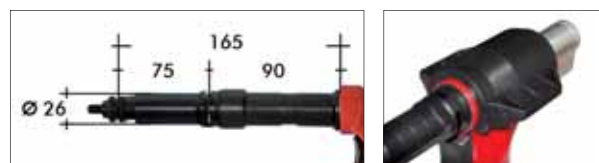

Rivettatrice oleopneumatica per inserti (1 fase)

Hydropneumatic tool for rivet nuts (1 phase)

RIV938S

35002

Tipo	Codice
Model	Item code
RIV938S	4143500



Per inserti filettati femmine
RIVSERT da M3 a M6.

To place RIVSERT female
rivet nuts from M3 to M6.

RIV938S per applicare inserti utilizzando la regolazione della forza.
Avvitamento automatico posizionando il tirante sull'inserto,
1 FASE deformazione e svitamento inserto.

Per non utilizzare più il tirante speciale, è stato progettato un sistema
che alloggia una vite a brugola in acciaio classe 12.9, facile da reperire
e da sostituire.

Vantaggi: montaggio kit senza uso della chiave | non occorre nessuna
regolazione al variare dello spessore | nessun danno alla vite se l'operazione di
deformazione dell'inserto viene ripetuta.

RIV938S to place rivet nuts using force adjustment.

Automatic screwing by positioning the tie rod in the rivet nut,
1 PHASE rivet nut deformation and unscrewing.

In order to avoid the use of a special rod, a system has been projected
to lodge an allen screw (hardness class 12.9), easy to find on the
market and replace.

Advantages: kit assembling without use of the key | does not require
any regulation to the vary of the thickness | no damage to the screw if the
operation of deformation of the rivet nut is repeated.

Ricambi per RIVSERT

Spare parts for RIVSERT



Ø inserti	Kit	Codice kit	* Cod. vite (DIN912 12.9)
Rivet nuts Ø	Kit code	Kit code	* Screw code (DIN912 12.9)
M3	938S/03	3758400	3756600
M4	938S/04	3758500	3757500
M5	938S/05	3758600	3757900
M6	938S/06	3758700	3758200

* La vite è compresa nel "codice kit" e può essere ordinata a parte.

* Screw is included in the "kit code" and can be ordered separately.



Accessori a richiesta

Optional

Descrizione	Codice
Description	Item code
Protezione alare antigraffio Anti-scratch wing protection	4217600

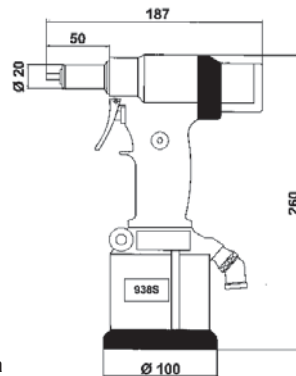

RIV938S viene venduta in cassetta senza
il kit della testata anteriore.

In base alla misura dell'inserto che si
deve utilizzare, aggiungere all'ordine il kit
corrispondente composto da vite+testina
(vedi tabella ricambi per RIVSERT).

RIV938S is supplied in a case without the
frontal head kit, which is composed by
screw + head.

Choose the correct kit according to the
size of the rivet nut to be placed, and add
it to the order
(see spare parts for RIVSERT).

Dati tecnici e caratteristiche

Technical data and features

Pressione aria esercizio Air working pressure	6 bar
Pressione aria min-max Min-max air pressure	5/7 bar
Consumo aria per ciclo 6 bar Air consumption per cycle (6 bar)	5 lt
Corsa Stroke	6.5 mm
Forza di trazione a 6 bar Max power (6 bar)	20000 N
Peso (senza kit) Weight (without kit)	1.868 kg
Vibrazioni Vibrations	< 2,5 m/s ²
Rumorosità Noise level	76 dB (A)



Regolazione della forza
Force adjustment

Rivettatrice oleopneumatica per inserti (1 fase)

Hydropneumatic tool for rivet nuts (1 phase)

RIV939

35002

Tipo	Codice
Model	Item code
RIV939	4621500

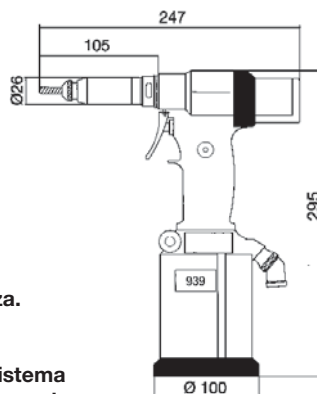

Per inserti filettati femmine RIVSERT da M3 a M12 e inserti filettati maschi RIVBOLT da M4 a M10.
To place RIVSERT female rivet nuts from M3 to M12 and RIVBOLT male rivet nuts from M4 to M10.

RIV939 per applicare inserti utilizzando la regolazione della forza.

Avvitamento automatico posizionando il tirante sull'inserto,
1 FASE deformazione e svitamento inserto.

Per non utilizzare più il tirante speciale, è stato progettato un sistema che alloggia una vite a brugola in acciaio classe 12.9, facile da reperire e da sostituire.

Vantaggi: montaggio kit senza uso della chiave | non occorre nessuna regolazione al variare dello spessore | nessun danno alla vite se l'operazione di deformazione dell'inserto viene ripetuta.
RIV939 to place rivet nuts using force adjustment.

Automatic screwing by positioning the tie rod in the rivet nut,
1 PHASE rivet nut deformation and unscrewing.

In order to avoid the use of a special rod, a system has been projected to lodge an allen screw (hardness class 12.9), easy to find on the market and replace.

Advantages: kit assembling without use of the key | does not require any regulation to the vary of the thickness | no damage to the screw if the operation of deformation of the rivet nut is repeated.

Ricambi per RIVSERT (metrico)

Spare parts for RIVSERT (metric)



Ø inserti	Kit	Codice kit	* Cod. vite (DIN912 12.9)
Rivet nuts Ø	Kit code	Kit code	* Screw code (DIN912 12.9)
M3	939/03	3441100	3457600
M4	939/04	3441200	3470500
M5	939/05	3441300	3471900
M6	939/06	3441400	3472300
M8	939/08	3441500	3472800
M10	939/10	3441600	3473100
M12	939/12	3441700	3473300

* La vite è compresa nel "codice kit" e può essere ordinata a parte.

* Screw is included in the "kit code" and can be ordered separately.

Ricambi per RIVSERT (UNC)

Spare parts for RIVSERT (UNC)



Ø inserti	Kit	Codice kit	Cod. tirante (speciale)
Rivet nuts Ø	Kit code	Kit code	Tie rod code (special)
1/2-13 UNC	939/1/2-13 UNC	4361600	4187000

Ricambi per RIVBOLT

Spare parts for RIVBOLT



Ø inserti	Kit	Codice kit	* Cod. tirante femmina
Rivet nuts Ø	Kit code	Kit code	* Female tie rod code
M4	939/04B	3442300	3441900
M5	939/05B	3442400	3442000
M6	939/06B	3442500	3442100
M8	939/08B	3442600	3442200
M10	939/10B	4601900	4601800

* Il tirante femmina è compreso nel "codice kit" e può essere ordinato a parte.

* The female tie rod is included in the "kit code" and can be ordered separately.

Accessori a richiesta

Optional

Descrizione	Codice
Description	Item code
KIT939-Testata speciale prolunga KIT939-Special extended head	3531800
Protezione alare antigraffio Anti-scratch wing protection	4217600



RIV939 viene venduta in cassetta senza il kit della testata anteriore. In base alla misura dell'inserto che si deve utilizzare, aggiungere all'ordine il kit corrispondente (vedi tabella ricambi RIVSERT/RIVBOLT).
RIV939 is supplied in a case without the frontal head kit. Choose the correct kit according to the size of the rivet nut to be placed, and add it to the order (see the spare parts for RIVSERT/RIVBOLT).

Dati tecnici e caratteristiche

Technical data and features

Pressione aria esercizio Air working pressure	6 bar
Pressione aria min-max Min-max air pressure	5/7 bar
Consumo aria per ciclo 6 bar Air consumption per cycle (6 bar)	5 lt
Corsa Stroke	6.5 mm
Forza di trazione a 6 bar Max power (6 bar)	26600 N
Peso (senza kit) Weight (without kit)	2.200 kg
Vibrazioni Vibrations	< 2,5 m/s ²
Rumorosità Noise level	76 dB (A)



Regolazione della forza
Force adjustment

Rivettatrice oleopneumatica per inserti (1 fase)

Hydropneumatic tool for rivet nuts (1 phase)

RIV941

35002

Tipo	Codice
Model	Item code
RIV941	4292300

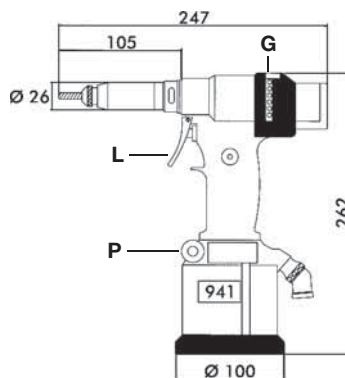

Per inserti filettati femmine RIVSERT da M3 a M10 e inserti filettati maschi RIVBOLT da M4 a M10.

To place RIVSERT female rivet nut, from M3 to M10 and RIVBOLT male rivet nut, from M4 to M10.

RIV941 per applicare inserti utilizzando in un unico attrezzo due sistemi di regolazione: corsa e forza.

REGOLAZIONE (vedi disegno tecnico):

- 1) Regolazione forza tramite la rotazione del pomello (P).
- 2) Regolazione corsa tramite ghiera (G).
- 3) Tenendo premuta la levetta si ottiene deformazione e svitamento inserto (L).

Avvitamento automatico posizionando il tirante sull'inserto,

1 FASE deformazione e svitamento inserto.

Per non utilizzare più il tirante speciale, è stato progettato un sistema che alloggia una vite a brugola in acciaio classe 12.9, facile da reperire e da sostituire.

Vantaggi: montaggio kit senza uso della chiave | non occorre nessuna regolazione al variare dello spessore | nessun danno alla vite se l'operazione di deformazione dell'inserto viene ripetuta.

RIV941 to place rivet nuts using 2 adjustment systems in just 1 tool: stroke and force.

ADJUSTMENT (check the technical drawing):

- 1) Pressure adjustment through the knob rotation (P).
- 2) Stroke adjustment through the ring nut (G).
- 3) By pulling the trigger the rivet nut gets deformed and unscrewed (L).

Automatic screwing by positioning the tie rod in the rivet nut,

1 PHASE rivet nut deformation and unscrewing.

In order to avoid the use of a special rod, a system has been projected to lodge an allen screw (hardness class 12.9), easy to find on the market and replace.

Advantages: kit assembling without use of the key | does not require any regulation to the vary of the thickness | no damage to the screw if the operation of deformation of the rivet nut is repeated.



RIV941 viene venduta in cassetta senza il kit della testata anteriore.

In base alla misura dell'inserto che si deve utilizzare, aggiungere all'ordine il kit corrispondente

(vedi tabella ricambi RIVSERT/RIVBOLT). RIV941 is supplied in a case without the frontal head kit.

Choose the correct kit according to the size of the rivet nut to be placed, and add it to the order (see the spare parts for RIVSERT/RIVBOLT).

Ricambi per RIVSERT

Spare parts for RIVSERT



Ø inserti	Kit	Codice	* Cod. vite (DIN912 12.9)
Rivet nuts Ø	Item code	Item code	* Screw code (DIN912 12.9)
M3	941/03	3441100	3457600
M4	941/04	3441200	3470500
M5	941/05	3441300	3471900
M6	941/06	3441400	3472300
M8	941/08	3441500	3472800
M10	941/10	3441600	3473100

* La vite è compresa nel "codice kit" e può essere ordinata a parte.

* Screw is included in the "kit code" and can be ordered separately.

Ricambi per RIVBOLT

Spare parts for RIVBOLT



Ø inserti	Kit	Codice	* Cod. tirante femmina
Rivet nuts Ø	Item code	Item code	* Female tie rod code
M4	941/04B	3442300	3441900
M5	941/05B	3442400	3442000
M6	941/06B	3442500	3442100
M8	941/08B	3442600	3442200
M10	941/10B	4601900	4601800

* Il tirante femmina è compreso nel "codice kit" e può essere ordinato a parte.

* The female tie rod is included in the "kit code" and can be ordered separately.

Dati tecnici e caratteristiche

Technical data and features

Pressione aria esercizio	6 bar
Air working pressure	6 bar
Pressione aria min-max	5/7 bar
Min-max air pressure	5/7 bar
Consumo aria per ciclo 6 bar	5 lt
Air consumption per cycle (6 bar)	5 lt
Corsa	6.5 mm
Stroke	6.5 mm
Forza di trazione a 6 bar	19000 N
Max power (6 bar)	19000 N
Peso (senza kit)	2.100 kg
Weight (without kit)	2.100 kg
Vibrazioni	< 2,5 m/s ²
Vibrations	< 2,5 m/s ²
Rumorosità	76 dB (A)
Noise level	76 dB (A)



Regolazione corsa.
Stroke adjustment.



Regolazione forza
Force adjustment

Rivettatrice oleopneumatica per inserti (2 fasi)

Hydropneumatic tool for rivet nuts (2 phases)

RIV942

35002

Tipo	Codice
Model	Item code
RIV942	1701600

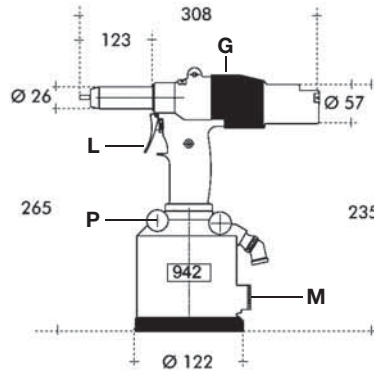

Per inserti filettati femmine RIVSERT da M4 a M12 e inserti filettati maschi RIVBOLT da M4 a M10.

To place RIVSERT female rivet nuts from M4 to M12 and RIVBOLT male rivet nut from M4 to M10.

RIV942 per applicare inserti utilizzando in un unico attrezzo due sistemi di regolazione: corsa e forza.

REGOLAZIONE (vedi disegno tecnico):

1) Regolazione forza tramite la rotazione del pomello (P), tenendo premuta la levetta (L) sulla prima fase (trazione) si legge il valore della pressione aria sul manometro (M).

2) Regolazione corsa tramite ghiera (G).

Avvitamento automatico posizionando il tirante sull'inserto,

1 FASE deformazione inserto - 2 FASE svitamento inserto.

Per non utilizzare più il tirante speciale, è stato progettato un sistema che alloggia una vite a brugola in acciaio classe 12.9, facile da reperire e da sostituire.

Vantaggi: montaggio kit senza uso della chiave | non occorre nessuna regolazione al variare dello spessore | nessun danno alla vite se l'operazione di deformazione dell'inserto viene ripetuta.

RIV942 to place rivet nuts using 2 adjustment systems

in just 1 tool: stroke and force.

ADJUSTMENT (check the technical drawing):

1) Pressure adjustment through the knob rotation (P) and keeping the trigger (L) pushed on the first step (traction) you can read the air pressure value on the manometer (M).

2) Stroke adjustment through the ring nut (G).

Automatic screwing by positioning the tie rod in the rivet nut,

1 PHASE rivet nut deformation and unscrewing - 2 PHASE rivet nut unscrewing.

In order to avoid the use of a special rod, a system has been projected to lodge an allen screw (hardness class 12.9), easy to find on the market and replace.

Advantages: kit assembling without use of the key | does not require any regulation to the vary of the thickness | no damage to the screw if the operation of deformation of the rivet nut is repeated.



RIV942 viene venduta in cassetta senza il kit della testata anteriore. In base alla misura dell'inserto che si deve utilizzare, aggiungere all'ordine il kit corrispondente (vedi tabella ricambi RIVSERT/RIVBOLT).

RIV942 is supplied in a case without the frontal head kit. Choose the correct kit according to the size of the rivet nut to be placed, and add it to the order (see the spare parts for RIVSERT/RIVBOLT).

Ricambi per RIVSERT

Spare parts for RIVSERT



Ø inserti	Kit	Codice	* Cod. vite (DIN912 12.9)
Rivet nuts Ø	Item code		* Screw code (DIN912 12.9)
M4	942/04	3441200	3470500
M5	942/05	3441300	3471900
M6	942/06	3441400	3472300
M8	942/08	3441500	3472800
M10	942/10	3441600	3473100
M12	942/12	4259200	3473300

* La vite è compresa nel "codice kit" e può essere ordinata a parte.

* Screw is included in the "kit code" and can be ordered separately.

Ricambi per RIVBOLT

Spare parts for RIVBOLT



Ø inserti	Kit	Codice	* Cod. tirante femmina
Rivet nuts Ø	Item code		* Female tie rod code
M4	942/04B	3442300	3441900
M5	942/05B	3442400	3442000
M6	942/06B	3442500	3442100
M8	942/08B	4259400	3442200
M10	942/10B	4601900	4601800

* Il tirante femmina è compreso nel "codice kit" e può essere ordinato a parte.

* The female tie rod is included in the "kit code" and can be ordered separately.

Dati tecnici e caratteristiche

Technical data and features

Pressione aria esercizio	6 bar
Air working pressure	
Pressione aria min-max	5/7 bar
Min-max air pressure	
Consumo aria per ciclo 6 bar	7.5 lt
Air consumption per cycle (6 bar)	
Corsa	10 mm
Stroke	
Forza di trazione a 6 bar	31000 N
Max power (6 bar)	
Peso (senza kit)	3.100 kg
Weight (without kit)	
Vibrazioni	< 2,5 m/s ²
Vibrations	
Rumorosità	< 80 dB (A)
Noise level	



Manometro regolazione pressione aria
Manometer for pressure adjustment



Regolazione corsa
Stroke adjustment

Manometer for air pressure adjustment.



Rivettatrice oleopneumatica verticale per inserti (1 fase)

Vertical hydropneumatic tool for rivet nuts (1 phase)

RIV949

35002

Tipo	Codice
Model	Item code
RIV949	4560800



Per inserti filettati femmine RIVSERT da M3 a M12 e inserti filettati maschi RIVBOLT da M4 a M10.

To place RIVSERT female rivet nut, from M3 to M12 and RIVBOLT male rivet nut, from M4 to M10.

RIV949 per applicare inserti utilizzando in un unico attrezzo due sistemi di regolazione: corsa e forza.

Avvitamento automatico posizionando il tirante sull'inserto, 1 FASE deformazione e svitamento inserto.

Per non utilizzare più il tirante speciale, è stato progettato un sistema che alloggia una vite a brugola in acciaio classe 12.9, facile da reperire e da sostituire. Tutto ciò rende il lavoro di applicazione più veloce e meno faticoso per gli operatori i quali possono appenderla ad un bilanciatore.

RIV949 to place rivet nuts using 2 adjustment systems in just 1 tool: stroke and force.

Automatic screwing by positioning the tie rod in the rivet nut, 1 PHASE rivet nut deformation and unscrewing.

In order to avoid the use of a special rod, a system has been projected to lodge an allen screw (hardness class 12.9), easy to find on the market and replace. This innovative technical device makes vertical down applications quicker and fatigue-proof as it can be hung on a balancer.

È possibile fornire anche la testata senza booster.

It is also possible to provide the head without booster.



Tipo	Codice
Model	Item code
RIV949T	5042300

Ricambi per RIVSERT

Spare parts for RIVSERT



Ø inserti	Kit	Codice kit	* Cod. vite (DIN912 12.9)
Rivet nuts Ø	Kit code	Kit code	* Screw code (DIN912 12.9)
M3	949/03	3441100	3457600
M4	949/04	3441200	3470500
M5	949/05	3441300	3471900
M6	949/06	3441400	3472300
M8	949/08	3441500	3472800
M10	949/10	3441600	3473100
M12	949/12	3441700	3473300

* La vite è compresa nel "codice kit" e può essere ordinata a parte.

* Screw is included in the "kit code" and can be ordered

Ricambi per RIVBOLT

Spare parts for RIVBOLT



Ø inserti	Kit	Codice kit	* Cod. tirante femmina
Rivet nuts Ø	Kit code	Kit code	* Female tie rod code
M4	949/04B	3442300	3441900
M5	949/05B	3442400	3442000
M6	949/06B	3442500	3442100
M8	949/08B	3442600	3442200
M10	949/10B	4601900	4601800

* Il tirante femmina è compreso nel "codice kit" e può essere ordinato a parte.

* The female tie rod is included in the "kit code" and can be ordered separately.

Braccio con carrello

Arm with trolley

Descrizione	Codice
Description	Item code
Braccio triplo snodo testata regolabile - raggio di lavoro 1900 mm Triple articulated arm with adjustable head - work radius 1900 mm	4811800
Carrello con ruote - dimensioni 850x750 mm, peso 65 kg Trolley with wheels - dimensions 850x750 mm, weight 65 kg	4811900

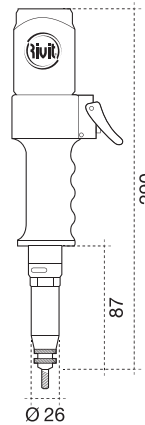

RIV949 viene venduta senza il kit della testata anteriore. In base alla misura dell'inserto che si deve utilizzare aggiungere all'ordine il kit corrispondente (vedi tabella ricambi RIVSERT/RIVBOLT).

RIV949 is supplied without the frontal head kit. Choose the correct kit according to the size of the rivet nut to be placed, and add it to the order (see the spare parts for RIVSERT/RIVBOLT).

Dati tecnici e caratteristiche

Technical data and features

Pressione aria esercizio Air working pressure	6 bar
Pressione aria min-max Min-max air pressure	5/7 bar
Corsa Stroke	6.5 mm
Forza di trazione a 6 bar Max power (6 bar)	23500 N
Peso (senza impugnatura) Weight (without handle)	2.0 kg
Peso totale Total weight	21.0 kg
Lunghezza tubo Hose length	2.5 m
Dimensioni box Box dimensions	500x300x210
Vibrazioni Vibrations	< 2,5 m/s ²
Rumorosità Noise level	76.0 dB (A)

Se la forza attuale dichiarata non dovesse essere sufficiente, può essere personalizzata secondo le esigenze del prodotto, sostituendo l'intensificatore (booster).

If the tensile strength declared is not sufficient, the booster can be customized according to the product needs.



Rivettatrice oleopneumatica per inserti (1 fase)

Hydropneumatic tool for rivet nuts (1 phase)

RIV916

35002

Tipo	Codice
Model	Item code
RIV916	4154500

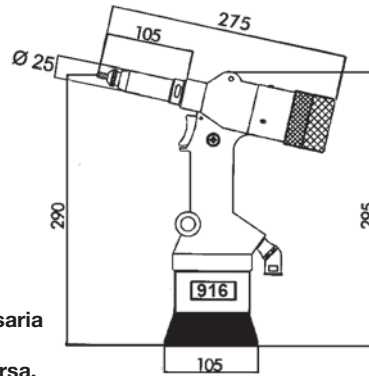

Per inserti TUBRIV e JACKRIV da M4 a M10.

To place TUBRIV and JACKRIV rivet nuts from M4 to M10.

RIV916 è nata per esigenze di serraggio dove è necessaria una corsa lunga 16 mm per l'applicazione degli inserti TUBRIV e JACKRIV, utilizzando la regolazione della corsa.

Avvitamento automatico posizionando il tirante sull'inserto, 1 FASE deformazione e svitamento inserto.

Per non utilizzare più il tirante speciale, è stato progettato un sistema che alloggia una vite a brugola in acciaio classe 12.9, facile da reperire e da sostituire.

Vantaggi: montaggio kit senza uso della chiave | non occorre nessuna regolazione al variare dello spessore | nessun danno alla vite se l'operazione di deformazione dell'inserto viene ripetuta.

RIV916 comes from the need of a fixing tool with a stroke 16 mm long for the application of special rivet nuts, such as TUBRIV and JACKRIV, using stroke adjustment.

Automatic screwing by positioning the tie rod in the rivet nut, 1 PHASE rivet nut deformation and unscrewing.

In order to avoid the use of a special rod, a system has been projected to lodge an allen screw (hardness class 12.9), easy to find on the market and replace.

Advantages: kit assembling without use of the key | does not require any regulation to the vary of the thickness | no damage to the screw if the operation of deformation of the rivet nut is repeated.

Ricambi per JACKRIV / TUBRIV

Spare parts for JACKRIV / TUBRIV



Ø inserti	Kit	Codice	* Cod. vite (DIN912 12.9)
Rivet nuts Ø		Item code	* Screw code (DIN912 12.9)
M4	916/04	4186300	4186400
M5	916/05	4186500	4186600
M6	916/06	4186700	4186800
M8	916/08	4186900	4187000
M10	916/10	4187100	4187200

* La vite è compresa nel "codice kit" e può essere ordinata a parte.

* Screw is included in the "kit code" and can be ordered separately.

Esempi di applicazione

Examples of application



Jackriv



Tubriv



RIV916 viene venduta in cassetta senza il kit della testata anteriore.

In base alla misura dell'inserto che si deve utilizzare, aggiungere all'ordine il kit corrispondente

(vedi tabella ricambi per JACKRIV/TUBRIV).

RIV916 is supplied in a case without the frontal head kit.

Choose the correct kit according to the size of the rivet nut to be placed, and add it to the order (see the spare parts for JACKRIV/TUBRIV).

Dati tecnici e caratteristiche

Technical data and features

Pressione aria esercizio	6 bar
Air working pressure	
Pressione aria min-max	5/7 bar
Min-max air pressure	
Consumo aria per ciclo 6 bar	7.5 lt
Air consumption per cycle (6 bar)	
Corsa	16 mm
Stroke	
Forza di trazione a 6 bar	13000 N
Max power (6 bar)	
Peso (senza kit)	2.558 kg
Weight (without kit)	
Vibrazioni	< 2,5 m/s ²
Vibrations	
Rumorosità	78.5 dB (A)
Noise level	

Rivettatrice oleopneumatica per inserti (1 fase)

Hydropneumatic tool for rivet nuts (1 phase)

RIV916B

35002

Tipo	Codice
Model	Item code
RIV916B	4194400



Per inserti RIVSERT da M8 a M20.

To place RIVSERT rivet nuts from M8 to M20.

RIV916B per applicare inserti utilizzando in un unico
attrezzo due sistemi di regolazione: corsa e forza.

Avvitamento automatico posizionando il tirante sull'inserto,
1 FASE deformazione e svitamento inserto.

Per non utilizzare più il tirante speciale, è stato progettato un sistema
che alloggia una vite a brugola in acciaio classe 12.9, facile da reperire
e da sostituire.

Vantaggi: montaggio kit senza uso della chiave | non occorre nessuna
regolazione al variare dello spessore | nessun danno alla vite se l'operazione di
deformazione dell'inserto viene ripetuta.

RIV916B to place rivet nuts using 2 adjustment systems in just 1 tool:
stroke and force.

Automatic screwing by positioning the tie rod in the rivet nut,
1 PHASE rivet nut deformation and unscrewing.

In order to avoid the use of a special rod, a system has been projected
to lodge an allen screw (hardness class 12.9), easy to find on the
market and replace.

Advantages: kit assembling without use of the key | does not require any
regulation to the vary of the thickness | no damage to the screw if the operation
of deformation of the rivet nut is repeated.

Ricambi per RIVSERT (metrico)

Spare parts for RIVSERT (metrical)



Ø inserti	Kit	Codice	* Cod. vite (DIN912 12.9)
Rivet nuts Ø	Item code	Item code	* Screw code (DIN912 12.9)
M8	916B/08	4228600	4227600
M10	916B/10	4228800	4227900
M12	916B/12	4228900	4228200

* La vite è compresa nel "codice kit" e può essere ordinata a parte.

* Screw is included in the "kit code" and can be ordered separately.

Ø inserti	Kit	Codice	Cod. tirante speciale
Rivet nuts Ø	Item code	Item code	Special tie rod code
M14	916B/14	4229000	4228500
M16	916B/16	4208800	4209000
M20	916B/20	4702800	4702700

Ricambi per RIVSERT (UNC)

Spare parts for RIVSERT (UNC)



Ø inserti	Kit	Codice	Cod. tirante speciale
Rivet nuts Ø	Item code	Item code	Special tie rod code
5/16-18UNC	916B/5/16-18UNC	4698100	-
3/8-16UNC	916B/3/8-16UNC	4698200	-
1/2-13UNC	916B/1/2-13UNC	4466700	-
5/8-11UNC	916B/5/8-11UNC	4355400	4363400
3/4-10UNC	916B/3/4-10UNC	4366300	4366400

Ricambi per RIVSERT a richiesta

Spare parts for RIVSERT on request

Ø inserti	Kit	Codice	Cod. tirante speciale
Rivet nuts Ø	Item code	Item code	Special tie rod code
M18	-	-	-
5/16-24 UNF	-	-	-
3/8-24 UNF	-	-	-
1/2-20 UNF	-	-	-
3/4-16 UNF	-	-	-



RIV916B viene venduta senza il kit della testata
anteriore. In base alla misura dell'inserto che si deve
utilizzare aggiungere all'ordine il kit corrispondente
(vedi tabella ricambi RIVSERT).

RIV916B is supplied without the frontal head kit.
Choose the correct kit according to the size of the
rivet nut to be placed, and add it to the order
(see the spare parts for RIVSERT).

Dati tecnici e caratteristiche

Technical data and features

Pressione di alimentazione Min/max air pressure	6 bar
Pressione aria min-max Min-max air pressure	5/7 bar
Trazione a 6 bar Tensile strength (6 bar)	80000 N
Corsa pistone Cylinder stroke	1-15 mm
Peso impugnatura (senza kit) Handle weight (without kit)	2.6 Kg
Peso totale Total weight	34.2 kg
Lunghezza tubo Hose length	3.0 m - 1/4" gas
Pressione olio Oil pressure	300 bar
Dimensioni booster (LxPxH) Booster dimensions (WxDxH)	49.5x 39.5x25.0
Vibrazioni Vibrations	< 2.5 m/s ²
Rumorosità Noise level	78.1 dB (A)
Rapporto di intensificazione Intensification ratio	50 : 1

Se la forza attuale dichiarata non dovesse
essere sufficiente, può essere personalizzata
secondo le esigenze del prodotto, sostituendo
l'intensificatore (booster).

If the tensile strength declared is not
sufficient enough, the booster can be
customized according to the product needs.

Esagonatrice oleopneumatica da M4 a M10

Hydropneumatic hexcutter from M4 to M10

RIV990

35002

Tipo	Codice
Model	Item code
RIV990	2986300

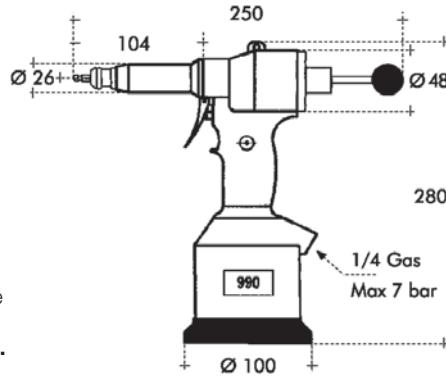

Per inserti esagonali RIVSERT da M4 a M10.

To place hexagonal RIVSERT rivet nuts from M4 to M10.

Il sistema di scantonatura, grazie a uno speciale punzone e matrice posizionati sulla parte anteriore della testata, **permette di trasformare un foro tondo in esagonale**. È possibile così alloggiare inserti esagonali su profili già piegati o scatolati di lamiera.

A round off system, thanks to a special punch housed in the front of the head, **can easily transform a round hole into a hexagonal one**.

This allows the use of hexagonal rivet nuts on already folded profiles and on metal boxes.

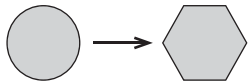

RIV990 viene venduta in cassetta senza punzoni e matrici. In base alla misura dell'inserto che si deve utilizzare, aggiungere all'ordine il punzone e la matrice corrispondenti (vedi tabella accessori a richiesta).

RIV990 is sold in a case without punches and dies. Order the proper punch and die separately, according to the size of the rivet nut to be placed (see table for optional parts).

Accessori a richiesta

Optional

Ø inserti esagonali Hexagonal rivet nuts Ø	Codice punzone Punch code	Codice matrice Die code
* M4	4196900	-
M5	2974900	2975300
M6	2925000	2925100
M8	2975000	2975400
** M10	2975100	2975500

* Kit completo punzone + matrice esagonale 6 per inserto M4.

* Complete kit supplied with hexagonal die 6/punch for M4 rivet nut.

** Kit completo punzone + matrice esagonale 13 per inserto M10 (**4520500**).

** Complete kit supplied with hexagonal die 13/punch for M10 rivet nut.



Punzone + matrice
Punch + die



Matrice
Die



Punzone
Punch

Esempi di applicazione

Examples of application



Spessore materiale

Sheet metal thickness

Misura Size	Alluminio Aluminium	Acciaio Steel	Inox S/steel
M4	0.5-2.5	0.5-1.5	0.5-1.5
M5	0.5-4.5	0.5-3.0	0.5-1.5
M6	0.5-4.5	0.5-3.0	0.5-1.5
M8	0.5-4.5	0.5-3.0	0.5-1.5
M10	0.5-4.5	0.5-3.0	0.5-1.5

Dati tecnici e caratteristiche

Technical data and features

Pressione aria esercizio Air working pressure	6 bar
Pressione aria min-max Min-max air pressure	5/7 bar
Consumo aria per ciclo 6 bar Air consumption per cycle (6 bar)	2.5 lt
Corsa Stroke	6.0 mm
Forza di trazione a 6 bar Max power (6 bar)	19000 N
Peso (senza kit) Weight (without kit)	2.133 kg
Vibrazioni Vibrations	< 2,5 m/s ²
Rumorosità Noise level	< 80 dB (A)

Misura Size	Preforato Predrilled	Esagono Hexagon
M4	6.25	6
M5	7.25	7
M6	* 9.25-9.50	9
M8	* 11.25-11.50	11
M10	* 13.25-13.50	13

* In base allo spessore del materiale utilizzato.

* Depending on the thickness of the used material.

Esagonatrice oleopneumatica da M5 a M12

Hydropneumatic hexcutter from M5 to M12

RIV991

35002

Tipo	Codice
Model	Item code
RIV991	4630400



Per inserti esagonali RIVSERT da M5 a M12.

To place hexagonal RIVSERT rivet nuts from M5 to M12.

Il sistema di scantonatura, grazie a uno speciale punzone e matrice posizionati sulla parte anteriore della testata, **permette di trasformare un foro tondo in esagonale**. È possibile così alloggiare inserti esagonali su profili già piegati o scatonati di lamiera.

A round off system, thanks to a special punch housed in the front of the head, **can easily transform a round hole into a hexagonal one**.

This allows the use of hexagonal rivet nuts on already folded profiles and on metal boxes.

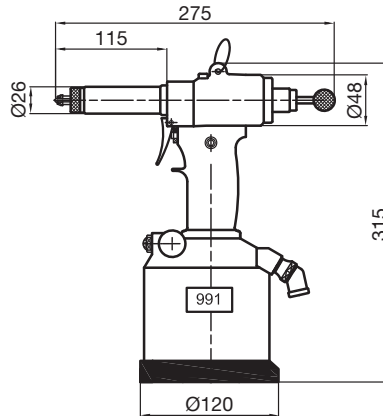
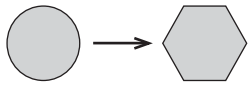

Accessori a richiesta

Optional

Ø inserti esagonali Hexagonal rivet nuts Ø	Codice punzone Punch code	Codice matrice Die code
M5	2974900	2975300
M6	2925000	2925100
M8	2975000	2975400
* M10	4669500	2975500
** M12	4669400	4669300

* Kit completo punzone + matrice esagonale 13 per inserto M10 (**4631900**).

* Complete kit supplied with hexagonal die 13/punch for M10 rivet nut.

** Kit completo punzone + matrice esagonale 16 per inserto M12 (**4669200**).

** Complete kit supplied with hexagonal die 16/punch for M12 rivet nut.



Punzone + matrice
Punch + die



Matrice
Die



Punzone
Punch

Esempi di applicazione

Examples of application



Spessore materiale

Sheet metal thickness

Misura Size	Alluminio Aluminium	Acciaio Steel	Inox S/steel
M5	0.5-5.0	0.5-3.0	0.5-1.5
M6	0.5-6.0	0.5-3.0	0.5-1.5
M8	0.5-6.0	0.5-3.0	0.5-1.5
M10	0.5-6.0	0.5-3.0	0.5-1.5
M12	0.5-6.0	0.5-3.0	0.5-1.5

RIV991 viene venduta in cassetta senza punzoni e matrici. In base alla misura dell'inserto che si deve utilizzare, aggiungere all'ordine il punzone e la matrice corrispondenti (vedi tabella accessori a richiesta).

RIV991 is sold in a case without punches and dies. Order the proper punch and die separately, according to the size of the rivet nut to be placed (see table for optional parts).

Dati tecnici e caratteristiche

Technical data and features

Pressione aria esercizio Air working pressure	6 bar
Pressione aria min-max Min-max air pressure	5/7 bar
Consumo aria per ciclo 6 bar Air consumption per cycle (6 bar)	2.5 lt
Corsa Stroke	12.0 mm
Forza di trazione a 6 bar Max power (6 bar)	21000 N
Peso (senza kit) Weight (without kit)	2.400 kg
Vibrazioni Vibrations	< 2,5 m/s ²
Rumorosità Noise level	< 80 dB (A)

Misura Size	Preforato Predrilled	Esagono Hexagon
M5	7.25	7
M6	* 9.25-9.50	9
M8	* 11.25-11.50	11
M10	* 13.25-13.50	13
M12	* 16.25-16.50	16

* In base allo spessore del materiale utilizzato.

* Depending on the thickness of the used material.

Rivettatrici ad aria a pistola per inserti

Air gun tool for rivet nuts

RIV806

35002

Tipo	Codice
Model	Item code
RIV806	4197000

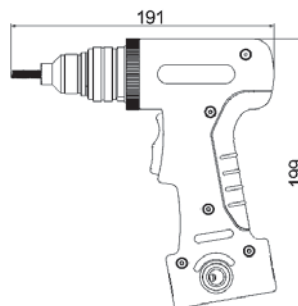

Per applicare inserti da M3 a M5 (M6 solo alluminio).
To place rivet nuts from M3 to M5 (M6 aluminum only).

Struttura ergonomica rivestita, per il comfort dell'operatore. Doppio attacco d'aria (dx/sx). Scarico dell'aria incorporato per ridurre al minimo la rumorosità dell'attrezzo. Grilletto a bilancino per facilitare il controllo operativo.
Ergonomic, coated structure for the comfort of the operator.
Double air inlet (right/left). Built-in exhaust muffler to minimize the tool noise.
Rocking trigger for the ease of operational control.

RIV806 viene venduta con kit M6.
RIV806 is supplied with kit M6.

Dati tecnici e caratteristiche

Technical data and features

Pressione aria esercizio Air working pressure	6.2 bar
Pressione aria min-max Min-max air pressure	5/7 bar
Consumo aria per ciclo 6 bar Air consumption per cycle (6 bar)	9.9 lt
Velocità Speed	1500 rpm
Peso (senza kit) Weight (without kit)	1.022 kg
Vibrazioni Vibrations	< 2,5 m/s ²
Rumorosità Noise level	95 dB (A)

Ricambi per RIVSERT

Spare parts for RIVSERT



Ø inserti Rivet nuts Ø	Kit	Codice Item code	* Cod. vite (DIN912 12.9) * Screw code (DIN912 12.9)
M3	806/03	4197500	24055GR
M4	806/04	4197600	21912GR
M5	806/05	4197700	21911GR
M6	806/06	4218100	21910GR

* La vite è compresa nel "codice kit" e può essere ordinata a parte.

* Screw is included in the "kit code" and can be ordered separately.

RIV810

35002

Tipo	Codice
Model	Item code
RIV810	4197100

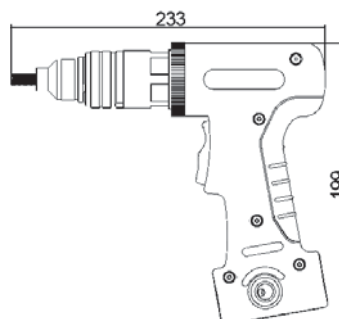

Per applicare inserti da M6 a M10.
To place rivet nuts from M6 to M10.

Ricambi per RIVSERT

Spare parts for RIVSERT



Ø inserti Rivet nuts Ø	Kit	Codice Item code	* Cod. vite (DIN912 12.9) * Screw code (DIN912 12.9)
M6	810/06	4218100	21910GR
** M8	810/08	4218200	23709GR
M10	810/10	4197800	21930GR

* La vite è compresa nel "codice kit" e può essere ordinata a parte.

* Screw is included in the "kit code" and can be ordered separately.

** Fornito montato sulla pistola (di serie).

** Assembled on head (included).

RIV810 viene venduta con kit M8.
RIV810 is supplied with kit M8.

Dati tecnici e caratteristiche

Technical data and features

Pressione aria esercizio Air working pressure	6.2 bar
Pressione aria min-max Min-max air pressure	5/7 bar
Consumo aria per ciclo 6 bar Air consumption per cycle (6 bar)	9.9 lt
Velocità Speed	500 rpm
Peso (senza kit) Weight (without kit)	1.275 kg
Vibrazioni Vibrations	< 2,5 m/s ²
Rumorosità Noise level	95 dB (A)



Pomolo regolazione aria in base all'inserto che si deve utilizzare.
Adjusting air knob according to the rivet nut to be placed.

Attacco aria 3/8 gas.
3/8" gas air connector.

Rivettatrice a batteria per inserti

Battery tool for rivet nuts

RIV790

05001

Tipo	Codice
Model	Item code
RIV790	1551600

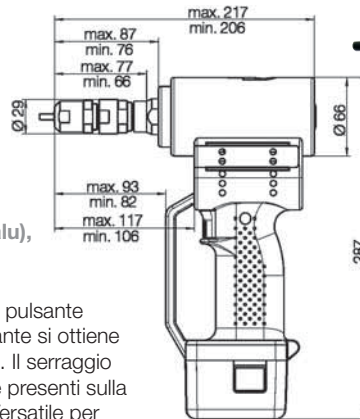

Per inserti da M3 a M8 (acciaio, inox, alluminio), M10 solo in alluminio.

To place rivet nuts from M3 to M8 (steel, s/steel, alu), M10 for aluminium only.

L'inserto viene posizionato contro il tirante; azionando il pulsante viene avvicinato alla testina; azionando di nuovo il pulsante si ottiene la deformazione dell'inserto e lo svitamento automatico. Il serraggio dell'inserto avviene mediante la regolazione delle ghiere presenti sulla parte anteriore. Corpo compatto e resistente agli urti. Versatile per lavorare ovunque.

The rivet nut is positioned against the tie rod; pushing the trigger the rivet nut is automatically screwed against the head; pushing again the trigger we obtain the rivet nut deformation and the automatic unscrewing. Rivet nut clamping occurs by means of regulation of the front ring nuts. Compact and bumps resistant body. Versatile, to be used anywhere.

Ricambi

Spare parts

Foto	Descrizione	Ah	Codice
Picture	Description		Item code
	Batteria litio 14.4 V Lithium battery 14.4 V	1.3	42076RT
	Batteria litio 14.4 V Lithium battery 14.4 V	2.6	42077RT
	Caricabatteria universale Universal battery charger	-	42075RT



RIV790 viene venduta in cassetta metallica con una batteria al litio di 1.3 Ah, un caricabatteria, tiranti e testine.

RIV790 is supplied in a metallic case, with a lithium battery of 1.3 Ah, a battery charger, tie rods and heads.

Ricambi per RIVSERT

Spare parts for RIVSERT



Ø inserti	Codice tiranti	Codice testine
Rivet nuts Ø	Tie rod code	Head code
◦ M3	1551700	1552300
• M4	1551800	1552400
• M5	1551900	1552500
• M6	1552000	1552600
◦ M8	1552100	1552700
* ◦ M10	1552200	1552800

* Solo in alluminio | Aluminium only • In dotazione con l'attrezzo | Supplied with the tool
◦ A richiesta | On request

Ricambi per JACKRIV / TUBRIV

Spare parts for JACKRIV / TUBRIV



Ø inserti	Codice tiranti	Codice testine
Rivet nuts Ø	Tie rod code	Head code
M6	4194100	1552600
M8	4194200	1552700

Kit per RIVBOLT

Kits for RIVBOLT



Ø inserti	Kit	Codice kit
Rivet nuts Ø	Kit code	Kit code
M4	790/04B	4773000
M5	790/05B	4773100
M6	790/06B	4773200
M8	790/08B	4773300

Dati tecnici e caratteristiche

Technical data and features

Alimentazione batteria	14.4 Volt
Operating voltage	14.4 Volt
Corsa	20 mm
Stroke	20 mm
Caricabatteria	200 W-50 Hz
Battery charger	200 W-50 Hz
Forza di trazione	13000 N
Tensile strength	13000 N
Peso c/batteria	2.374 kg
Weight w/battery	2.374 kg

Caricatore automatico per inserti

Automatic feeder for rivet nuts

RIV616

05096

Tipo	Codice
Model	Item code
RIV616	4835200



Per inserti da M3 a M8 fusto cilindrico ed esagonale, a testa cilindrica, svasata e filo lamiera.

For rivet nuts from M3 to M8, hexagonal or cylindrical shank, dome, countersunk, reduced head.

Il caricatore automatico è un'apparecchiatura elettrica ed ad aria che permette il posizionamento dell'inserto direttamente nella testa della rivettatrice, riducendo i tempi di posa.

Può essere utilizzata con diversi tipi di rivettatrici per inserti, come RIV938, RIV939, RIV941.

La RIV616 viene venduta senza il kit guida, in base alla misura dell'inserto che si deve utilizzare aggiungere all'ordine il kit guida corrispondente.

Se si necessita di utilizzare altre misure ordinare il kit guida adatto (vedi tabella).

The new Rivit automatic rivet nuts feeder is a pneumatic and electric tool, which allows to insert the rivet nuts directly on the head of the tool, reducing the riveting implementation time.

It can be used with many riveting tools for rivet nuts such as RIV938, RIV939, RIV941.

RIV616 is sold without the guide kit; depending on the measure of the rivet nut to be placed please order the correct one (see guide table).

If other measures are needed order them from the guide table.



Da abbinare ad una rivettatrice per inserti.
(da ordinare a parte).

To be combined with a tool for rivet nuts.
(to be ordered separately).

Dati tecnici e caratteristiche

Technical data and features

Alimentazione elettrica Voltage	220 V - 50 Hz
Aria Air pressure	2/4 bar
Dimensioni macchina (LxPxH) Tool dimensions (WxDxH)	340x530x300 cm
Peso Weight	32 kg
Peso con cassa (spedizione) Weight with box (shipment)	43 kg
Dimensioni cassa (LxPxH) Box dimensions (WxDxH)	72x57x52 cm

Kit guida per RIV616

Guides for RIV616

Foto Picture	Misura inserti Rivet nuts measure	Kit	Codice kit Kit code
	M3	616/03	5004800
	M4	616/04	5004900
	M5	616/05	5005000
	M6	616/06	5005100
	M8	616/08	5005200

Le misure della guida sono disponibili anche in pollici.

Measures of the guide are also available in inches.



L'inserto è caricato automaticamente sulla testa dell'utensile, ciò consente all'operatore di avere sempre una mano libera.

Rivet nuts are screwed automatically on the head of the tool, it's a one hand operation which allows operativity for the other hand.

Dal vibratore gli inserti vengono caricati nell'imbocco del caricatore.

The vibrator loads the rivet nuts into the feeder.

Rivettatrici abbinabili

Tools for blind rivets to be combined



Rivettatrice oleopneumatica RIV938
RIV938 hydropneumatic tool
Cod. 4143400



Rivettatrice oleopneumatica RIV939
RIV939 hydropneumatic tool
Cod. 4621500



Rivettatrice oleopneumatica RIV941
RIV941 hydropneumatic tool
Cod. 4292300

Sistema di controllo per inserti

Rivet nuts control system

CONTROLRIV

35002

Il sistema di controllo permette di monitorare l'installazione dell'inserto o rivetto secondo le impostazioni predeterminate dall'operatore.

Consente di avere un controllo puntuale delle lavorazioni evitando errori e disattenzioni; si avrà un miglioramento della produttività, della qualità del lavoro svolto ed una riduzione degli scarti.

Caratteristiche:

Allarme visivo e sonoro per applicazioni corrette o sbagliate; allarme visivo e sonoro se aria non presente; valvola pneumatica per impedire ulteriori errori durante la lavorazione e maggiori sicurezze sull'impianto; conta pezzi e conta lotti; settaggi direttamente dal modulo; modulo orientabile per una miglior visione ed ergonomia della postazione di lavoro; interfaccia operatore di facile comprensione; livelli di intervento con password; archiviazione dati per i lotti impostati; archiviazione per verifiche sia dei dati OK che dei dati NOK.

The system allows to control the placing of the rivet nuts or blind rivets according to the predetermined settings made by the operator.

It allows to have a precise control of the work, avoiding mistakes and oversights, you have improved productivity, quality of work and a reduction in waste.

Features:

Visual and sound alarm for right or wrong application. Visual and sound alarm if there is no air. Pneumatic valve to prevent further errors during processing and more safety devices on the system. Piece counter and lots counter. Settings directly made from the module. Adjustable module for better vision and ergonomomy of the workstation. Operator interface easy to understand.

Intervention levels with password. Data storage for lots set. Data storage whether data is OK or NOK for later verification.



Modelli
Models



RIV938CB



RIV939CB



RIV949CB



RIV938CW



RIV939CW



RIV949CW

Applicazioni
Applications



Applicazioni in serie, controllo qualità, catene di montaggio, automotive e carrozzeria industriale.

Controlriv consente di controllare e certificare che il lavoro sia fatto secondo determinati criteri; ciò ne fa aumentare il valore rispetto ai concorrenti.

Applications in series, quality control, assembly lines, automotive and industrial bodywork.

Controlriv allows to check and certify that the work is done according to specific criteria; this increases its value compared to competitors.

Specifiche
Features



Impostazione del lavoro.
Work setup.



Supporto multilingua.
Multi language support.



Contapezzi e contalotti.
Pieces and lots counter.



Segnalazione OK.
Curve OK, valid.

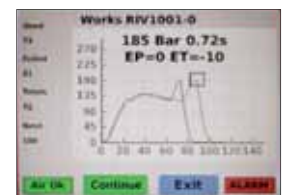

Segnalazione errore.
Curve NOK, alarm.



Sistema di controllo con rivettatrice per inserti

Control system with tool for rivet nuts

CONTROLRIV

35002

Tipo	Codice
Model	Item code
RIV938CB	4640300
RIV939CB	4814900
RIV949CB	5152100



Modello Basic

Basic Model

Si compone di una scheda elettronica dotata di collegamento USB2 per il trasferimento dei dati di lavorazione sul PC e LAN per collegamento a internet.

Attraverso il PC è possibile: impostare il numero complessivo di inserti da installare, suddividere in lavorazioni singole il numero complessivo di inserti da installare, abbinare la lavorazione ad un cliente, fermare il processo di lavorazione in caso di errore nella lavorazione, memorizzare, stampare le lavorazioni effettuate, statistiche sulle lavorazioni.

It consists of a circuit board with USB 2 connection for processing data transfer to the PC and LAN port for internet connection. On the PC you can: set the total number of rivet nuts to install, divide into individual processing the total number of rivet nuts to install, match the processing to a customer, stop the process in case of error, save and print the operations carried out, produce statistics on processing.

Tipo	Codice
Model	Item code
RIV938CW	4640600
RIV939CW	5110600
RIV949CW	5166100

Modello Wireless

Wireless Model

Si compone di una scheda elettronica dotata di collegamento LAN e Wi-Fi per il trasferimento dei dati di lavorazione sul PC.

Attraverso il PC è possibile: impostare il numero complessivo di inserti da installare, suddividere in lavorazioni singole il numero complessivo di inserti da installare, abbinare la lavorazione ad un cliente, fermare il processo di lavorazione in caso di errore nella lavorazione, memorizzare, stampare le lavorazioni effettuate, statistiche sulle lavorazioni.

It consists of a circuit board with LAN and Wi-Fi connection for processing data transfer to the PC.

On the PC you can: set the total number of rivet nuts to install, divide into individual processing the total number of rivet nuts to install, match the processing to a customer, stop the process in case of error, save and print the operations carried out, produce statistics on processing.

Ricambi per RIVSERT

Spare parts for RIVSERT



Ø inserti	Kit	Codice kit	* Cod. vite (DIN912 12.9)
Rivet nuts Ø	Kit	Kit code	* Screw code (DIN912 12.9)
M3	938/03	3441100	3457600
M4	938/04	3441200	3470500
M5	938/05	3441300	3471900
M6	938/06	3441400	3472300
M8	938/08	3441500	3472800
M10	938/10	3441600	3473100

* La vite è compresa nel "codice kit" e può essere ordinata a parte.

* Screw is included in the "kit code" and can be ordered separately.



Il sistema di controllo viene fornito completo di rivettatrice per inserti; il kit non è incluso ed è da acquistare a parte in base alla misura dell'inserto da installare.

Cavo di collegamento lungo 3 m.

The control system is supplied complete with tool for rivet nuts. Kit for placing is not included and must be ordered separately, according to the size of rivet nut to place.

Connecting cable 3 m.

Modelli

Models



RIV938



RIV939



RIV949



Tipo	Descrizione	Codice
Model	Description	Item code
RIV601CA	Per rivetti (c/aspirazione) For blind rivets (with suction)	4101100
RIV601SA	Per rivetti (s/aspirazione) For blind rivets (without suction)	4619900
RIV602	Per rivetti in cartuccia For cartridge blind rivets	4345700
RIV603	Per inserti For rivet nuts	4259800
RIV604	Per bulloni a strappo For blind bolts	4259700



Modulo per rivetti (c/ aspirazione)
Blind rivets module (with suction)



Modulo per rivetti (s/aspirazione)
Blind rivets module (without suction)



Modulo per rivetti veloci in cartuccia
Speed rivets in cartridge module



Modulo per inserti
Rivet nuts module

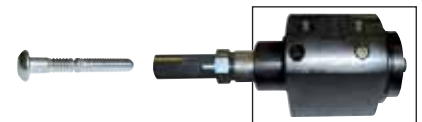

Modulo per bulloni a strappo
Blind bolts module

I sistemi multitesta Rivit consentono di applicare più fasteners contemporaneamente.

Rivit multi head system is designed for setting several fasteners simultaneously.

I vantaggi di questi sistemi non vanno individuati solamente nella simultaneità di applicazione dei prodotti ma anche nella riduzione di tempi di manipolazione dei componenti da assemblare.

L'elemento principale dei sistemi multitesta è rappresentato dai moduli a funzionamento idraulico attivati da un moltiplicatore di pressione centralizzato.

What the customers will surely appreciate in this most effective installation system, is not only the simultaneity of fasteners application, but also an outstanding reduction in implementation times of assembling operations. The hydraulic operated modules represent the main feature of the Rivit Multi Head Systems. They are all started by a centralized pressure multiplier.

Esempio di banco corredato di moduli

Example of bench equipped with modules



Realizzabile in varie dimensioni a seconda del tipo di applicazione.

Questi moduli sono progettati per essere installati su delle linee automatiche, perciò sono all'attenzione dei progettisti di automatismi. I moduli sono oleopneumatici e devono essere alimentati con olio, aria e apposite centraline.

Available in various sizes depending on the type of application.

These modules are projected to be installed on automatic lines; that's why they have to be proposed to the project engineers working for automation. These modules are hydropneumatic and must be supplied with oil, air and the corresponding control unit.

Legenda banchetto

Desk legend

Rif.	Descrizione
	Description
A	Modulo Module
B	Booster di rivettatura/insertatura con valvola di scarico rapido Booster for riveting/inserting with straight safety valve
C	Pedale di comando rivettatura/insertatura Pedal control for riveting/inserting
D	Scivolo per il recupero gambi di scarico Discharge chute for nails recovery
E	Telaio in alluminio Aluminium loom
F	Piano di appoggio Supporting top

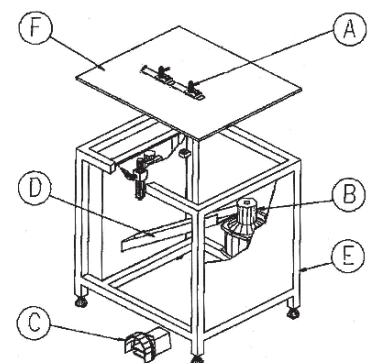

Esempio di banchetto con testate multiple
Example of multi head system desk

Modulo per inserti da M3 a M12

Module for rivet nuts from M3 to M12

RIV603
05096

Tipo	Codice
Model	Item code
RIV603	4259800





Questi moduli sono progettati per essere installati su delle linee automatiche, perciò sono all'attenzione dei progettisti di automatismi.

These tools (modules) are designed to be installed on automatic lines; that is why they are proposed to the project engineers working for automation.

I moduli sono oleopneumatici e devono essere alimentati con olio, aria e apposite centraline.
The tools (modules) are dropneumatic and must be supplied with oil, air and the corresponding control unit.

Accessori per completare la testata

Accessories to complete the head

Foto	Descrizione	Codice
Picture	Description	Item code
	Cono esterno (accessorio esterno) External cone (External accessory)	3539900
	Kit rapido con molla (accessorio interno) Quick kit with spring (internal accessory)	4174200











Dati tecnici e caratteristiche

Technical data and features

Corsa del pistone Piston stroke	0 - 12 mm
Pressione max olio in ingresso Min-max air pressure	350 bar (atm)
Superficie utile per calcolo forza Surface for strength calculation	11.02 cm ²
Forza max di trazione kg 3.850 Max driving force kg 3.850	38500 N

Kit completi per inserti

Complete kits for rivet nuts

Foto	Descrizione	Codice
Picture	Description	Item code
	Kit per Rivsert M3 Kit for Rivsert M3	3441100
	Kit per Rivsert M4 Kit for Rivsert M4	3441200
	Kit per Rivsert M5 Kit for Rivsert M5	3441300
	Kit per Rivsert M6 Kit for Rivsert M6	3441400
	Kit per Rivsert M8 Kit for Rivsert M8	3441500
	Kit per Rivsert M10 Kit for Rivsert M10	3441600
	Kit per Rivsert M12 Kit for Rivsert M12	3441700
	Kit per Rivbolt M4 Kit for Rivbolt M4	3442300
	Kit per Rivbolt M5 Kit for Rivbolt M5	3442400
	Kit per Rivbolt M6 Kit for Rivbolt M6	3442500
	Kit per Rivbolt M8 Kit for Rivbolt M8	3442600



Esempio di modulo completo:

Example of complete module



Accessori a richiesta

Optional

Foto	Descrizione	Codice
Picture	Description	Item code
	Pedaliera (da collegare al circuito pneumatico) Rudder pedal (to be connected to the pneumatic circuit)	4259900

Testine prolungate per RIVSERT

Extended heads for RIVSERT



Prolunga 110/140 per RIVSERT M5

110/140 extension for RIVSERT M5

Descrizione	Codice	
Description	Item code	pz
Kit (testina prolungata + vite) Kit (head extension + screw)	4572500	1
Testina prolungata Ø 12x110/140 mm per RIVSERT M5 Head extension Ø 12x110/140 mm for RIVSERT M5	4570700	1
Vite TCCEI UNI 5931-DIN 912 12.9 grezza M5x170 Socket cap screw UNI 5931-DIN 912 12.9 plain M5x170	45513GR	1

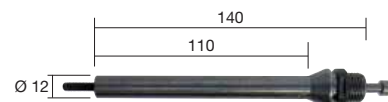

Prolunga 140/170 per RIVSERT M6

140/170 extension for Rivsert M6

Descrizione	Codice	
Description	Item code	pz
Kit (testina prolungata + vite) Kit (head extension + screw)	4572600	1
Testina prolungata Ø 12x140/170 mm per RIVSERT M6 Head extension Ø 12x140/170 mm for RIVSERT M6	4570800	1
Vite TCCEI UNI 5931-DIN 912 12.9 grezza M6x200 Socket cap screw UNI 5931-DIN 912 12.9 plain M6x200	45702GR	1

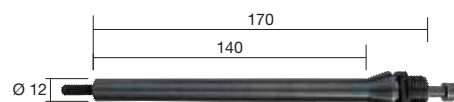

Prolunga 175/205 per RIVSERT M8

175/205 extension for RIVSERT M8

Descrizione	Codice	
Description	Item code	pz
Kit (testina prolungata + vite) Kit (head extension + screw)	4572700	1
Testina prolungata Ø 12x175/205 mm per RIVSERT M8 Head extension Ø 12/175x205 mm for RIVSERT M8	4570900	1
Vite TCCEI UNI 5931-DIN 912 12.9 grezza M8x240 Socket cap screw UNI 5931-DIN 912 12.9 plain M8x240	45514GR	1

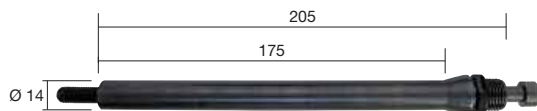

Il kit è composto dalla testina prolunga e dalla vite TCCEI.
The kit is composed of the head extension and the socket cap screw.



La lunghezza totale della prolunga si ottiene montando la testina prolungata sul canotto della macchina.

The total length of the extension is obtained mounting the head extension on the cone of the tool.



Prolunga da utilizzare con i seguenti modelli:

Extension to use with following models:



RIV905



RIV912



RIV938



RIV939



RIV941



RIV942

Tipo	Codice
Model	Item code
RSL0	0523000
RSL1	0523100
RSL2	0523200
RSP3	0523300
RSP4	1776100
RSP5	3397400
RSP6	3197100
RSP7	3109000

Bilanciatori per sostenere il peso di utensili manuali, rivettatrici, avvitatori, ecc.
Balancers to hold the weight of hand tools, riveting tools, screwdrivers, etc.

I bilanciatori sono un aiuto indispensabile per lavori ripetitivi, montaggi, produzioni di serie, imballaggi, ecc.

Sono costruiti con materiali di prima qualità e resistono a cicli di lavoro particolarmente gravosi. Esistono due diverse dimensioni.

Caratteristiche tecniche:

Struttura in alluminio pressofuso | cavo di sostegno in acciaio (art. RSL0, RSL1, RSL2: Ø 2 mm - art. RSP3, RSP4, RSP5, RSP6, RSP7: Ø 2.5 mm) | regolazione del carico continua dal valore massimo al valore minimo | corsa della fune facilmente registrabile per adattarsi ad ogni esigenza | tre punti di sospensione per garantire la massima sicurezza, come da normative | tre punti di ancoraggio per garantire la massima flessibilità.

The balancers are an indispensable aid for repetitive works, assemblies, serial productions, packaging, etc.

They are made with high quality materials and they can stand particularly heavy working cycles. They come in two different sizes.

Technical features:

Aluminium pressure die casting housing | steel supporting rope (item RSL0, RSL1, RSL2: Ø 2 mm - item RSP3, RSP4, RSP5, RSP6, RSP7: Ø 2.5 mm) | continuous load balancing from maximum to minimum value | stroke of the rope easily adjustable to adapt to every requirement | three suspension points to ensure the maximum safety, as by regulations | three anchor points to ensure maximum flexibility.

Dati tecnici e caratteristiche

Technical data and features

Modello	Portata (kg)	Corsa fune (mm)	Peso (kg)
Model	Capacity (kg)	Wire stroke (mm)	Weight (kg)
RSL0	0.4 : 1.0	1600	0.63
RSL1	1.0 : 2.0	1600	0.67
RSL2	2.0 : 3.0	1600	0.79
RSP3	2.0 : 4.0	2500	2.85
RSP4	4.0 : 6.0	2500	3.00
RSP5	6.0 : 8.0	2500	3.10
RSP6	8.0 : 10.0	2500	3.20
RSP7	10.0 : 14.0	2500	3.50

Accessori a richiesta

Optional

Foto	Descrizione	L	Codice
Picture	Description		Item code
	Kit tubo spiralato per aria per serie RSL Coiled air tube kit for RSL series	115 cm	1057800



RSL0
RSL1
RSL2



RSP3
RSP4
RSP5
RSP6
RSP7



Applicazione
attacco inferiore
Used with lower hook









Applicazione
attacco superiore
Used with upper hook



Applicazione del kit sul bilanciatore
Kit application on the balancer

Tabella per la scelta dell'attrezzo















Guide to the most appropriate installation tool

Tipo Model	Foto Picture	Peso Weight	Ø inserti Rivet nuts Ø								Pag Page
			M3	M4	M5	M6	M8	M10	M12	M16	
RIV900		910 g	■	■	■	-	-	-	-	-	83
RIV901		910 g	■	■	■	■	-	-	-	-	83
RIV903C		2200 g	■	■	■	■	■	■	-	-	83
RIV98		535 g	■	■	■	■ no inox	-	-	-	-	83
RIV905		1600 g	■	■	■	■	■	■	■	-	85
RIV906		1100 g	■	■	■	■	■	■	■	-	86
RIV918		540 g	-	◆	◆	◆	◆	-	-	-	87

■ Inserti filettati | Threaded rivet nuts
◆ Inserti JACKRIV | JACKRIV rivet nuts

Tabella per la scelta dell'attrezzo

Guide to the most appropriate installation tool

Tipo Model	Foto Picture	Corsa Stroke	Forza di trazione Max power	Peso Weight	Capacità rivettatura Riveting capacity								Pag Page
					M3	M4	M5	M6	M8	M10	M12	M16	
RIV998		0/6.5 mm	19000 N	2.405 kg	■	■	■	■	■	■	* ■	-	88
RIV912		1/6.5 mm	22500 N	2.501 kg	■	■	■	■	■	■	■	-	89
RIV938		6.5 mm	20000 N	2.041 kg	■	■	■	■	■	■	-	-	91
RIV938S		6.5 mm	14000 N	1.868 kg	■	■	■	■	-	-	-	-	93
RIV939		6.5 mm	26600 N	2.200 kg	■	■	■	■	■	■	■	-	94
RIV941		6.5 mm	19000 N	2.100 kg	■	■	■	■	■	■	-	-	95
RIV942		10 mm	31000 N	3.100 kg	-	■	■	■	■	■	■	-	96
RIV949		6.5 mm	23500 N	21.0 kg	■	■	■	■	■	■	■	-	97
RIV916		16 mm	13000 N	2.558 kg	-	◆	◆	◆	◆	◆	■	-	98
RIV916B		1-15 mm	80000 N	34.2 kg	-	-	-	-	■	■	■	■	99
RIV990		6.0 mm	19000 N	2.133 kg	-	●	●	●	●	●	-	-	100
RIV991		12 .0 mm	21000 N	2.400 kg	-	-	●	●	●	●	●	-	101
RIV806		-	-	1.022 kg	■	■	■	**■	-	-	-	-	102
RIV810		-	-	1.275 kg	-	-	-	■	■	■	-	-	102
RIV790		20 mm	13000 N	2.374 kg	■	■	■	◆	◆	**■	-	-	103

■ Inerti filettati | Threaded rivet nuts

◆ Inerti TUBRIV e JACKRIV | TUBRIV and JACKRIV rivet nuts

● Foro per inserti esagonali RIVSERT | Hole for RIVSERT hexagonal rivet nuts

* Solo alluminio e acciaio, no inox | Aluminium and steel only, no s/steel

** Solo alluminio | Aluminium only

LINEA COMPLETA RIVIT COMPLETE LINE RIVIT



RIVETTI A STRAPPO
BLIND RIVETS



cod. 2867900

INSERTI FILETTATI
RIVET NUTS



cod. 2955900

AUTOAGGANCIANTI
SELF CLINCHING



cod. 2868000

BULLONI A STRAPPO
BLIND BOLTS



cod. 3722400

PERNI A SALDARE
WELDING STUDS



DADI IN GABBIA E PIASTRINE
CAGED NUTS E SPRING CLIPS



FISSAGGI IN PLASTICA
PLASTIC FASTENERS



INSERTI PER LA PLASTICA
RIVET NUTS FOR PLASTIC



CHIUSURE A LEVA
TOGGLE LATCHES



CHIUSURE SOUTHCO
SOUTHCO LATCHES



cod. 5003700

VITERIA FERRO
STEEL SCREWS



cod. 4859600

VITERIA INOX
STAINLESS STEEL SCREWS



cod. 4859600

FASCETTE STRINGITUBO
HOSE CLIPS



cod. 4639900

UTENSILI PER FISSAGGIO
TOOLS FOR FASTENERS



cod. 3205000

LINEA BLISTER
SELF SERVICE BLISTERS



cod. 4713500

PORTA CATALOGHI
CATALOGUE HOLDER



cod. 4811200



RIVETTI A STRAPPO

BLIND RIVETS

RIVIT.IT

STANDARD TESTA TONDA

STANDARD DOME HEAD

	AFT
alluminio/acciaio aluminium/steel	
	AFTC
alluminio colorato/acciaio coloured aluminium/steel	
	AAT
alluminio/alluminio aluminium/aluminium	
	AIT
alluminio/inox aluminium/s/steel	
	AITC
alluminio colorato/inox coloured alum./s/steel	
	FFT
acciaio/acciaio steel/steel	
	RFT
rame/acciaio copper/steel	
	RZFT
rame zincato/acciaio zinc coated copper/steel	
	ROT
rame/ottone copper/brass	
	RBT
rame/bronzo copper/bronze	
	XIT
cupronichel/inox cupronickel/s/steel	
	IIT/A2
inox 304/inox 304 s/steel 304/s/steel 304	
	IIT/A4
inox 316/inox 316 s/steel 316/s/steel 316	

STANDARD TESTA SVASATA

STANDARD COUNTERSUNK HEAD

	AFS
alluminio/acciaio aluminium/steel	
	FFS
acciaio/acciaio steel/steel	
	XIS
cupronichel/inox cupronickel/s/steel	
	IIS/A2
inox/inox s/steel/s/steel	

STANDARD TESTA LARGA

STANDARD LARGE HEAD

	AFL
alluminio/acciaio aluminium/steel	
	AFLC
alluminio colorato/acciaio coloured aluminium/steel	
	FFL
acciaio/acciaio steel/steel	
	RFL
rame/acciaio copper/steel	
	ROL
rame/ottone copper/brass	
	XIL
cupronichel/inox cupronickel/s/steel	
	IIL/A2
inox/inox s/steel/s/steel	

STAGNI

SEALED

	SAFT
alluminio/acciaio aluminium/steel	
	SAIT
alluminio/inox aluminium/s/steel	
	SRFT
rame/acciaio copper/steel	
	SRIT
rame/inox copper/inox	
	SFFT
acciaio/acciaio steel/steel	
	SIIT/A2
inox/inox s/steel/s/steel	
	SAFS
alluminio/acciaio aluminium/steel	
	SAIS
alluminio/inox aluminium/s/steel	
	SAFL
alluminio/acciaio aluminium/steel	
	SIIL/A2
inox/inox s/steel/s/steel	





MULTIGRIPRIV STAGNI

SEALED MULTIGRIPRIV

	SMGIIT A2
inox/inox s/steel/s/steel	

FIORIV

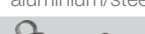
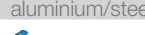
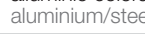
FIORIV

	FAFT
alluminio/acciaio aluminium/steel	
	FAFT PLUS
alluminio/acciaio aluminium/steel	
	FAFT PAN
alluminio/acciaio aluminium/steel	
	FAFTC
alluminio colorato/acciaio aluminium/steel	
	FAFL
alluminio/acciaio aluminium/steel	
	FRFL
rame/acciaio copper/steel	

TRERIV

TRERIV

	TAAT
alluminio/alluminio aluminium/aluminium	
	TAATL
alluminio/alluminio aluminium/aluminium	





GORIV

GORIV

	GAFT
alluminio/acciaio aluminium/steel	

MULTIGRIPRIV

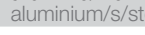
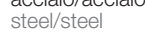
MULTIGRIPRIV

	MGAFT
alluminio/acciaio aluminium/steel	
	MGAFTC
alluminio colorato/acciaio coloured aluminium/steel	
	MGAIT
alluminio/inox aluminium/s/steel	
	MGFFT
acciaio/acciaio steel/steel	
	MGIIT/A2
inox/inox s/steel/s/steel	
	MGAFS
alluminio/acciaio aluminium/steel	



RIVETTI A STRAPPO

BLIND RIVETS

RIVIT.IT

MULTIGRIPRIV

 alluminio/acciaio aluminium/steel	MG AFL
 alluminio colorato/acciaio coloured aluminium/steel	MG AFLC
 alluminio/inox aluminium/s/steel	MG AIL
 acciaio/acciaio steel/steel	MG FFL

MAGNARIV

 alluminio/alluminio aluminium/aluminium	KA AT
 alluminio/alluminio aluminium/aluminium	KA AS
 acciaio/acciaio steel/steel	KFFT
 acciaio/acciaio steel/steel	KFFS
 inox/inox s/steel/s/steel	KIIT/A2
 inox/inox s/steel/s/steel	KIIS/A2

MONRIV

 alluminio/alluminio aluminium/aluminium	BA AT
 alluminio/alluminio aluminium/aluminium	BA AS
 acciaio/acciaio steel/steel	BFFT
 acciaio/acciaio steel/steel	BFFS
 inox/inox s/steel/s/steel	BIIT/A2
 inox/inox s/steel/s/steel	BIIS/A2

RIVBU

 acciaio/acciaio steel/steel	BUFFT
---	--------------

LOCKRIV

 alluminio/alluminio aluminium/aluminium	OA AT
 acciaio/acciaio steel/steel	OFFT
 alluminio/alluminio aluminium/aluminium	OA AS
 acciaio/acciaio steel/steel	OFFS
 acciaio/acciaio steel/steel	OFFL
 inox/inox s/steel/s/steel	OIIT/A2
 inox/inox s/steel/s/steel	OIIS/A2

GTRERIV

 alluminio/alluminio aluminium/aluminium	GTA AT
--	---------------

BULB-TITE

 alluminio/alluminio aluminium/aluminium	BTA AET
 alluminio/alluminio aluminium/aluminium	BTA AEL

FILRIV

 acciaio/acciaio steel/steel	FIL
---	------------

CAPRIV

 alluminio/acciaio aluminium/steel	CAPA F
---	---------------

SPHERIV

 alluminio/acciaio aluminium/steel	SPHA
---	-------------



BAMRIV

 acciaio/acciaio steel/steel	BMF
---	------------

RIVINOX

 inox/inox s/steel/s/steel	RIIT
---	-------------



TRIPLASTRIV

 nylon/nylon nero nylon/black nylon	PTR
 nylon/nylon nero nylon/black nylon	PTL

MASRIV







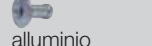

 ottone/acciaio ramato brass/coppered steel	MAS1
 ottone/acciaio ramato brass/coppered steel	MAS2
 ottone/acciaio ramato brass/coppered steel	MAS4

CANRIV

 alluminio/acciaio aluminium/steel	CANA F
 acciaio/acciaio steel/steel	CANFF

RIVETTI IN CARTUCCIA

SPEED RIVETS IN CARTRIDGE

 alluminio aluminium	BRAT
 alluminio colorato coloured aluminium	BRATC
 acciaio steel	BRFT
 inox s/steel	BRIT
 alluminio aluminium	BRAS
 acciaio steel	BRFS
 alluminio aluminium	CHAT
 acciaio steel	CHFT
 acciaio steel	CHFS
 acciaio steel	SCFT

RIVETTATRICI TOOLS FOR BLIND RIVETS

RIVIT.IT

OLEOPNEUMATICHE HYDROPNEUMATIC



OLEOPNEUMATICHE HYDROPNEUMATIC



A BATTERIA BATTERY



PER RIVETTI IN CARTUCCIA FOR SPEED RIVETS IN CARTRIDGE



SISTEMI DI CONTROLLO CONTROL SYSTEM



SISTEMI MODULARI E AUTOMATICI MODULAR AND AUTOMATIC SYSTEMS



RIVETTATRICI MANUALI HAND TOOLS FOR RIVETS



INSERTI FILETTATI RIVET NUTS

RIVIT.IT

IN ACCIAIO A FUSTO CILINDRICO STEEL CYLINDRICAL SHANK

	FTC
a testa tonda aperto open dome head	
	SFTC
a testa tonda cieco closed end dome head	
	FSC
a testa svasata aperto open countersunk head	
	SFSC
a testa svasata cieco closed end countersunk head	
	FRC-P
a testa ridotta aperto open reduced head	
	FRC
a testa ridotta aperto open reduced head	

IN ACCIAIO A FUSTO CILINDRICO ZIGRINATO STEEL KNURLED CYLINDRICAL SHANK

	FTC-Z
a testa tonda aperto open dome head	
	SFTC-Z
a testa tonda cieco closed end dome head	
	FSC-Z
a testa svasata aperto open countersunk head	
	SFSC-Z
a testa svasata cieco closed end countersunk head	
	FRC-Z
a testa ridotta aperto open reduced head	
	SFRC-Z
a testa ridotta cieco closed end reduced head	

IN ACCIAIO A FUSTO ESAGONALE STEEL HEXAGONAL SHANK

	FTE
a testa tonda aperto open dome head	
	SFTE
a testa tonda cieco closed end dome head	
	FRE
a testa ridotta aperto open reduced head	
	SFRE
a testa ridotta cieco closed end reduced head	





IN ACCIAIO A FUSTO SEMIESAGONALE STEEL SEMI HEXAGONAL SHANK

	FTEP
a testa tonda aperto open dome head	
	FREP
a testa ridotta aperto open reduced head	
	FREP-P
a testa ridotta aperto open reduced head	

IN ACCIAIO INOX A FUSTO CILINDRICO S/STEEL CYLINDRICAL SHANK

	ITC/A2
a testa tonda aperto open dome head	
	ITC/A4
a testa tonda aperto open dome head	
	SITC/A2
a testa tonda cieco closed end dome head	
	ISC/A2
a testa svasata aperto open countersunk head	

IN ACCIAIO INOX A FUSTO CILINDRICO S/STEEL CYLINDRICAL SHANK

	IRC/A2
a testa ridotta aperto open reduced head	
	IRC-P A2
a testa ridotta aperto open reduced head	
	IRC/A4
a testa ridotta aperto open reduced head	
	SIRC/A2
a testa ridotta cieco closed end reduced head	

IN ACC. INOX A FUSTO CILINDRICO ZIGRINATO S/STEEL KNURLED CYLINDRICAL SHANK

	ITC-Z A2
a testa tonda aperto open dome head	
	SITC-Z A2
a testa tonda cieco closed end dome head	
	IRC-Z A2
a testa ridotta aperto open reduced head	
	SIRC-Z A2
a testa ridotta cieco closed end reduced head	
	ISC-Z A2
a testa tonda aperto open dome head	

INSERTI FILETTATI RIVET NUTS

RIVIT.IT

IN ACCIAIO INOX A FUSTO SEMIESAGONALE S/STEEL SEMI HEXAGONAL SHANK

	I T E P /A 2
a testa tonda aperto open dome head	
	I T E P /A 4
a testa tonda aperto open dome head	
	S I T E P A 2
a testa tonda cieco closed end dome head	
	I R E P /A 2
a testa ridotta aperto open reduced head	
	I R E P /A 4
a testa ridotta aperto open reduced head	
	S I R E P A 2
a testa ridotta cieco closed end reduced head	
	S I R E P A 4
a testa ridotta cieco closed end reduced head	

IN ALLUMINIO A FUSTO CILINDRICO ALUMINIUM CYLINDRICAL SHANK

	A T C
a testa tonda aperto open dome head	
	S A T C
a testa tonda cieco closed end dome head	
	A S C
a testa svasata aperto open countersunk head	
	S A S C
a testa svasata cieco closed end countersunk head	
	A R C
a testa ridotta aperto open reduced head	

IN OTTONE A FUSTO CILINDRICO BRASS CYLINDRICAL SHANK

	O T C
a testa tonda aperto open dome head	

RIVBOLT RIVBOLT

	B F T C
in acciaio tondo steel dome	
	B F T E
in acciaio esagonale steel hexagonal	
	B I T C - Z A 2
in inox tondo s/steel dome	
	B I T E P A 2
in inox semiesagonale s/steel semi-hexagonal	

IN ACCIAIO INOX CON GUARNIZIONE S/STEEL WITH WASHER

	S T R E P G
in inox tondo s/steel dome	

DISTANZIALI SPACER

	F T C D
a testa tonda distanziale dome spacing head	

IN ACCIAIO PER SPESSORI SOTTILI STEEL FOR THIN THICKNESS

	F R T H
Thinsert	

QUADRI SQUARED

	S Q F
Squariv in acciaio steel Squariv	

PER MATERIALI SOFT FOR SOFT MATERIALS

	J K F
Jackriv in acciaio steel Jackriv	
	J K I
Jackriv in acciaio inox s/steel Jackriv	
	T B F
Tubriv in acciaio steel Tubriv	

IN NEOPRENE ANTIVIBRANTI NEOPRENE ANTI-VIBRATION

	N P T C
Prensert	

IN NYLON NYLON

	N B R C
Nylonsert	

RIVETTATRICI PER INSERTI TOOLS FOR RIVET NUTS

RIVIT.IT

OLEOPNEUMATICHE HYDROPNEUMATIC



OLEOPNEUMATICHE HYDROPNEUMATIC



PER JACKRIV E TUBRIV FOR JACKRIV AND TUBRIV



ESAGONATRICI HEXCUTTER TOOLS



OLEOPNEUMATICHE VERTICALI VERTICAL HYDROPNEUMATIC



A BATTERIA BATTERY



PISTOLA AD ARIA AIR GUN



RIVETTATRICI MANUALI PER INSERTI HAND TOOLS FOR RIVET NUTS



RIVETTATRICI MANUALI PER JACKRIV HAND TOOLS FOR JACKRIV RIVET NUTS



SISTEMI MODULARI E AUTOMATICI MODULAR AND AUTOMATIC SYSTEMS







SISTEMI DI CONTROLLO CONTROL SYSTEM



AUTOAGGANCIANTI SELF CLINCHING

RIVIT.IT

PRIGIONIERI PER FORO PASSANTE STUDS FOR THROUGH HOLES

	RFH
acciaio al carbonio carbon steel	
	RFHS
acciaio inox 303 s/steel 303	
	RHFH
acciaio al carbonio carbon steel	
	RHFHS
acciaio inox 303 s/steel 303	
	RFHL
acciaio al carbonio carbon steel	

PRIGIONIERI PER FORO CIECO STUDS FOR BLIND HOLES

	RCHC RCFHC
acciaio inox 303 s/steel 303	

PRIGIONIERI PER VETRONITE STUDS FOR EPOXY GLASSES

	RKFH
bronzo fosforoso phosphor bronze	

PRESSE PRESSES

	RIV2100
	RIV2200
	RIV2450



DADI TONDI ROUND NUTS

	RS
acciaio al carbonio carbon steel	
	RCLS
acciaio inox 303 s/steel 303	

DADI PIATTI FLAT NUTS

	RF
acciaio inox 303 s/steel 303	

DADI AUTOBLOCCANTI SELF LOCKING NUTS

	RPL
acciaio al carbonio carbon steel	
	RPLC
acciaio al carbonio s/steel 303	

DADI PER VETRONITE NUTS FOR EPOXY GLASSES

	RKF2
acciaio al carbonio carbon steel	
	RKFS2
acciaio inox 303 s/steel 303	

DADI ESAGONALI HEXAGONAL NUTS

	RKA
acciaio al carbonio carbon steel	
	RKAX
acciaio inox 303 s/steel steel 303	

DADI AD ANCORA ANCOR NUTS

	RARB MINARB
acciaio al carbonio carbon steel	
	RARBSO MINOFF
acciaio al carbonio carbon steel	



DISTANZIALI APERTI OPEN STANDOFFS

	RSO
acciaio al carbonio carbon steel	
	RSOS
acciaio inox 303 s/steel 303	

DISTANZIALI CIECHI BLIND STANDOFFS

	RBSO
acciaio al carbonio carbon steel	
	RBSOS
acciaio inox 303 s/steel 303	

DISTANZIALI PER FORO CIECO STANDOFFS FOR BLIND HOLES

	RCSS
acciaio inox 303 s/steel 303	
	RCSOS
acciaio inox 303 s/steel 303	

DISTANZIALI PER VETRONITE STANDOFFS FOR EPOXY GLASSES

	RKFE
acciaio al carbonio carbon steel	
	RKFSE
acciaio inox 303 s/steel 303	

VITI IMPERDIBILI A POMOLO PICCOLO CAPTIVE SCREWS WITH SMALL KNOB

	RPFC2
acciaio al carbonio carbon steel	

VITI IMPERDIBILI A POMOLO GRANDE CAPTIVE SCREWS WITH BIG KNOB

	RPF32
acciaio inox 303 s/steel 303	

PERNI A SALDARE WELDING STUDS

RIVIT.IT

PERNI FILETTATI THREADED STUDS

 acciaio ramato copper-plated steel	PFR
 acciaio inox s/steel	PFX
 alluminio aluminium	PFA
 ottone brass	PFO
 acciaio ramato copper-plated steel	PERCP
 acciaio ramato copper-plated steel	PERSP
 acciaio ramato copper-plated steel	PFRA

PERNI LISCI UNTHREADED STUDS

 acciaio ramato copper-plated steel	PLR
 acciaio inox s/steel	PLX
 alluminio aluminium	PLA
 ottone brass	PLO

BOCCOLE TAPPED STUDS

 acciaio ramato copper-plated steel	BFR
 acciaio inox s/steel	BFX
 alluminio aluminium	BFA
 ottone brass	BFO

FASTON FASTONS

 acciaio ramato copper-plated steel	F2R
 acciaio ramato copper-plated steel	F1R
 acciaio inox s/steel	F1X
 acciaio inox s/steel	F2X
 alluminio aluminium	F1A
 ottone brass	F1O

CHIODI PER ISOLAMENTO NAILS FOR INSULATION

 acciaio ramato liscio copper-plated steel-plain	IPL
 acciaio ramato zigrinato copper-plated steel-knurled	IPZ
 acciaio ramato per spot copper-plated steel	IPS

RONDELLE PER CHIODI ISO WASHERS FOR S/STEEL NAILS

 acciaio zincato zinc coated steel	RZ50
 polipropilene polypropylene	RP50

SALDATRICI STUDWELDING UNITS

 per perni M3-M8 for M3-M8 studs	RIVST80
 per perni M10 for M10 studs	RIVST90

ALIMENTATORI FEEDERS

 per caricamento automatico for automatic loading	RIV5000
--	---------











BULLONI A STRAPPO

BLIND BOLTS

RIVIT.IT









RIVLOCK - TESTA TONDA

RIVLOCK - DOME HEAD

		Collari standard Regular collars		Collari flangiati Flanged collars	
	RLFT		RLFCS		RLFCF
acciaio zincato zinc plated steel		acciaio zinc. steel		acciaio zinc. steel	
	RLAT		RLACS		RLACF
alluminio aluminium		alluminio aluminium		alluminio aluminium	
	RLXT		RLXCS		RLXCF
acciaio inox s/steel		acc. inox s/steel		acc. inox s/steel	

RIVLOCK - TESTA SVASATA

RIVLOCK - COUNTERSUNK HEAD

		Collari standard Regular collars		Collari flangiati Flanged collars	
	RLFS		RLFCS		RLFCF
acciaio zincato zinc plated steel		acciaio zinc. steel		acciaio zinc. steel	
	RLAS		RLACS		RLACF
alluminio aluminium		alluminio aluminium		alluminio aluminium	
	RLXS		RLXCS		RLXCF
acciaio inox s/steel		acc. inox s/steel		acc. inox s/steel	

RIVLOCKGRIP - TESTA TONDA

RIVLOCKGRIP - DOME HEAD

		Collari Collars	
	RGFT		RGFC
acciaio zincato zinc plated steel		acciaio zinc. steel	
	RGAT		RGAC
alluminio aluminium		alluminio aluminium	

RIVTAINER - TESTA TONDA

RIVTAINER - DOME HEAD

		Collari standard Regular collars	
	RTFT		RTFC
acciaio zincato zinc plated steel		acciaio zinc. steel	

BULLONATRICI

TOOLS FOR BLIND BOLTS

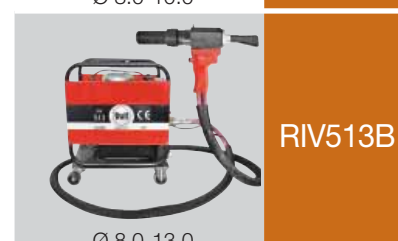

TAGLIA COLLARI

COLLAR CUTTER

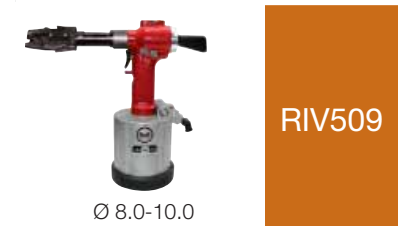

OCCHIELLI E RIBATTINI EYELETS AND RIVETS

RIVIT.IT

OCCHIELLI UNIFICATI UNIFIED EYELETS

 ottone brass	OU-OT
 ottone nichelato nicked brass	OU-ON
 acciaio ottonato brassed steel	OU-FO
 acciaio nichelato nicked steel	OU-FN



RIVETTI UNIFICATI UNIFIED RIVETS

 ottone brass	RU-OT
 ottone nichelato nicked brass	RU-ON
 acciaio ottonato brassed steel	RU-FO
 acciaio nichelato nicked steel	RU-FN

RIVETTI UNIFICATI (OLGO E TESTA) UNIFIED RIVETS (HEAD AND BODY)

 ottone lucido bright brass	RT-OT
 ottone nichelato nicked brass	RT-ON
 acciaio nichelato nicked steel	RT-FN



OCCHIELLI GARANZIA EYELETS WITH "GARANZIA" MARK

 ottone brass	OG-OT
 acciaio ottonato brassed steel	OG-FO





RIBATTINI PIENI TESTA BOMBATA NORMALE SOLID RIVETS NORMAL ROUND HEAD

 acciaio steel	TBN-FE
 alluminio aluminium	TBN-AL
 rame copper	TBN-CU



RIBATTINI PIENI TESTA PIANA SVASATA SOLID RIVETS COUNTERSUNK HEAD

 acciaio steel	TSP-FE
 alluminio aluminium	TSP-AL
 rame copper	TSP-CU

RIBATTINI SEMIFORATI SEMI TUBULAR RIVETS

 testa bombata normale normal round head	TBN-RS
 testa bombata larga large round head	TBL-RS
 testa piana cilindrica cylindrical flat head	TPC-RS
 testa piana svasata countersunk head	TSP-RS

RIBATTINI TUBOLARI TUBULAR RIVETS

 ottone brass	TUB-OT
 rame copper	TUB-CU

RIBATTINI AUTOFILETTANTI SELF-TAPPING RIVETS

 acciaio steel	RAT-BN
---	---------------

RIBATTINI A MARTELLO DRIVE RIVETS

 alluminio/acciaio inox aluminium/s/steel	RC-AI
--	--------------

TORCHIETTI MANUALI PER OCCHIELLI SMALL HAND PRESSES FOR EYELETS

	S2 - S3 S4 - S5
---	----------------------------

OCCHIELLATRICI MECCANICHE MECHANICAL EYELETING

	RIVOM06
--	----------------

OCCHIELLATRICI PNEUMATICHE PNEUMATIC EYELETING

	RIVOP10
---	----------------

RIBADITRICE A MOVIMENTO ORBITALE ORBITAL RIVETING MACHINE

	RIV3450P
---	-----------------









INSERTI PER PLASTICA, LEGNO E LEGHE LEGGERE

RIVET NUTS FOR PLASTIC, WOOD AND LIGHT ALLOYS

RIVIT.IT









PER MATERIALI TERMOPLASTICI - A CALORE

FOR THERMOPLASTICS MATERIALS - HEATING

 ottone brass	RSL
 ottone brass	RHSL
 ottone brass	RTC
 ottone brass	RHL
 ottone brass	RHHL
 ottone brass	RMC

PER MATERIALI TERMOPLASTICI - A PRESSIONE

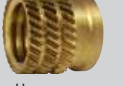
FOR THERMOPLASTICS MATERIALS - PRESSURE

 ottone brass	RFL
 ottone brass	RHFL
 ottone brass	RPLK
 ottone brass	RBL
 ottone brass	RHBL
 ottone brass	RHBLR
 ottone brass	RSP
 ottone brass	RHSP

COSTAMPAGGIO

INSERT MOLDING

 ottone brass	RFTC
--	------

PER LEGNO - AUTOFILETTANTI

FOR WOOD - SELF TAPPING





 ottone brass	RBW
--	-----

PER METALLI LEGGERI, LEGHE DI ALLUMINIO, OTTONE, BRONZO E GHISA

FOR LIGHT METALS, ALLOYS OF ALUMINUM, BRASS, BRONZE AND CAST IRON

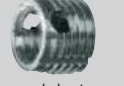

BUSSOLE AUTOFILETTANTI

SELF TAPPING SOCKETS

 acciaio temperato temperated steel	RSCT
 acciaio inox s/steel	RSCT-X
 ottone brass	RSCT-O
 ottone brass	RHSCT
 acciaio temperato temperated steel	RSCF-F
 acciaio inox s/steel	RSCF-X

INSERTI PER RIPRISTINO FILETTI

INSERTS FOR RECOVERY THREADS

 acciaio inox s/steel	ELIRIV
 acciaio inox s/steel	KEIRIV

FASCETTE STRINGITUBO JCS

JCS HOSE CLIPS

RIVIT.IT

HI-GRIP STANDARD

STANDARD HI-GRIP



HGZ

acciaio zincato lucido
mild steel zinc plated



HGS

acciaio inox AISI 304 (A2)
s/steel AISI 304 (A2)



HGJ

acciaio inox AISI 316 (A4)
s/steel AISI 316 (A4)

HI-GRIP A GALLETTO

HI-GRIP WING SCREW



WSZC

acciaio zincato lucido
mild steel zinc plated



WSSC

acciaio inox AISI 304 (A2)
s/steel AISI 304 (A2)

MINI

MINI



MCZ

acciaio zincato lucido
mild steel zinc plated

HI-TORQUE PER APPLICAZIONI SPECIALI

SPECIAL APPLICATIONS HI-TORQUE



HTM

acciaio inox AISI 304 (A2)
s/steel AISI 304 (A2)



HTJ

acciaio inox AISI 316 (A4)
s/steel AISI 316 (A4)

TAMTORQUE

TAMTORQUE



TTK

acciaio inox AISI 304 (A2)
s/steel AISI 304 (A2)

MULTI-TORQUE

MULTI-TORQUE



MTK

acciaio inox AISI 304 (A2)
s/steel AISI 304 (A2)

FASCETTE IN NYLON

NYLON CABLE TIES



FSNB

naturale - poliammide 66
natural - polyamide 66



FSNB

nero - poliammide 66
black - polyamide 66

P-CLIPS ANTIVIBRAZIONI

ANTI VIBRATIONS P-CLIPS



PCZ

acciaio zincato lucido-M6
mild steel zinc plated-M6



PCS

acciaio inox AISI 316-M6
s/steel AISI 316-M6



PEZH

acciaio zincato lucido-M10
mild steel zinc plated-M10



PESH

acciaio inox AISI 316-M10
s/steel AISI 316-M10

ASSORTIMENTO FASCETTE IN CASSETTA

ASSORTED CLIPS BOX



**HGZ
PCZ
PCS
MCZ**

HI-GRIP, P-CLIPS, MINI
HI-GRIP, P-CLIPS, MINI

ESPOSITORI DA BANCO

COUNTER DISPENSER



**DISPKZ
DISPKS**

HI-GRIP
HI-GRIP



VITERIA ACCIAIO E INOX

STEEL AND S/STEEL SCREWS

RIVIT.IT

VITI METRICHE

METRICS SCREWS

 DIN933 UNI5739 ISO4017	VTET
 DIN912 UNI5931 ISO4762	VTCEI
 DIN7991 UNI5933 ISO10642	VSPEI
 ISO7380	VBEI
 DIN7913 UNI5923 ISO4026	GPP
 DIN84 UNI6107 ISO1207	VTC-
 DIN963 UNI6109 ISO2009	VSP-
 DIN964 UNI6110 ISO2010	VTGS-
 DIN965 UNI7688 ISO7046	VTSP+
 DIN966 UNI7689 ISO7047	VTGS+
 DIN7985 UNI7687 ISO7045	VTC+
 DIN6921 ISO6921	VTEFR
 TAB FIAT 10453	VSCB
 DIN7500C	VTCT+
 DIN7500M	VSPT+
 DIN7500D	VTET+
 DIN603 UNI5732 con dado DIN603 UNI5731 senza dado	VTTQST

VITI METRICHE

METRICS SCREWS

 DIN9330	VTBL-
	VTBL±
	VTBL+

VITI AUTOFIETTANTI

SELFTAPPING SCREWS

	ATBL+
 DIN7981 UNI6954	ATC+
 DIN7982 UNI6955	ATSP+
 DIN7983 UNI6956	ATGS+
 UNI6947	ATCCE
 UNI6950	ATEFR
 DIN6954B UNI7981F	ATCSP+
	AATEFR
 COLORI BG-RS-TDM	VTPN
 DIN7982	ATSRF+
 DIN7981	ATCRF+

PIASTRINE

SPRING CLIPS

	PA
	PI



VITI AUTOFORANTI

SELFDRILLING SCREWS

 DIN7504 UNI8119	PTSP+
 DIN7504 UNI8119	PTSTX
 DIN7504 UNI8118	PTC+
 DIN7504 UNI8118	PTCTX
 DIN7504 UNI8117	PTEFR
	PTBFL+
	PAZPX
	PTZPX

VITI TRUCIOLARI

CHIPBOARD SCREWS

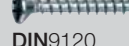
 DIN9100	TTSP+
 DIN9110	TTC+
 DIN9120	TTGS+

VITI TIRAFONDO

BOLT SCREWS

 DIN571 UNI704	TTE
 UNI6950	TTEFR









VITERIA ACCIAIO E INOX

STEEL AND S/STEEL SCREWS

RIVIT.IT



RONDELLE E MOLLE

WASHERS AND SPRINGS

 DIN125 UNI6592	RN
 DIN9021 UNI6593	RL
 DIN433	RP
 DIN137	RC
 DIN2093	MT
 DIN127 UNI1751	RG
 DIN7980	RGR
 ext DIN6798	RDE
 int DIN6798	RDI



GOLFARE

EYE NUTS

 DIN582	GF
 DIN580	GM





SEEGER

SNAP RING

 DIN471 UNI7435	SE
 DIN472 UNI7437	SI
 DIN6799	BZ

DADI

NUTS

 DIN316 UNI5449	VTED
 DIN315 UNI5448	DF
 UNI5587	DEA
 DIN394 UNI5588	DEM
 DIN936 UNI5589	DEB
 DIN439 UNI5590	DEUB
 DIN985 UNI7474	DEAB
 DIN982 UNI7473	DEAA
 DIN1587 UNI5721	DEC
 DIN6923	DEFZ
 DIN929	DG
 DIN928	DS
 DIN928	DQ
 DIN928	DTX
 DIN6334	DDG

RIBATTINI

RIVETS

 DIN9270	RB-TPC
 DIN660	RB-TPN
 DIN661	RB-TSP

SPINE

PINS

 DIN1471	SK
 DIN1481 UNI6873 ISO8752	SEP
 DIN7 UNI1707	SCL
 DIN1 UNI7283	SCO

BARRE

RODS

 DIN975	BF
---	----

COPIGLIE

COTTER PINS

 DIN94 UNI1336	COP
--	-----

FASCETTE

CLAMPS

 DIN3017	FAS
--	-----

CHIAVI E CHIAVETTE

KEYS AND EDGE KEYS

 UNI6604A	CHA
---	-----



CONDIZIONI GENERALI DI VENDITA

TERMS AND CONDITIONS

Ordini

Gli ordini vengono accettati alle condizioni di seguito previste, salvo pattuizioni diverse concordate per iscritto. La "Rivit Srl", qualora venissero a mancare i requisiti di correttezza commerciale e le garanzie di solvibilità da parte del committente, ha facoltà di sospendere o annullare gli ordini in corso o di richiederne il pagamento anticipato per contanti. Conferma d'ordine sarà inviata a:

- quei committenti che ne faranno esplicita richiesta.
- quei committenti che faranno pervenire ordini incompleti, inesatti, non chiari.
- quei committenti che faranno pervenire ordini via telefono e tramite internet. Si invita a consultare il catalogo indicando possibilmente i codici e le confezioni. Si invita a inviare gli ordini a mezzo fax allo 051/4171129, tramite e-mail all'indirizzo rivit@rivit.it o il portale www.rivit.it. Si invita alla richiesta di chiarimento per ogni dubbio o incertezza.

Orders

"Rivit Srl" accepts orders only when in accordance to the present general terms and conditions, unless otherwise clearly agreed upon in writing. "Rivit Srl" expressly reserves the right to suspend, cancel or ask for an anticipated cash payment for any order placed by Customers suspected of making purchases by fraudulent means. "Rivit Srl" will always send in writing (by fax or e-mail) the 'order confirmation' as acceptance of the order itself. Orders can be sent by fax +39 0514171129, e-mail export@rivit.it or by filling the form on our website www.rivit.it. Please feel free to contact us for any doubt or clarification.

Prodotti

La "Rivit Srl" si impegna a garantire la conformità dei propri prodotti ai requisiti espressamente specificati nel presente catalogo.

Products

"Rivit Srl" guarantees that the main technical characteristics of the products correspond to those specified in this catalogue.

Prezzi

Saranno applicati i prezzi in vigore all'atto della spedizione della merce. I listini possono essere variati in relazione alle condizioni di mercato senza preavviso. Il committente al momento dell'ordine dovrà sempre chiedere conferma scritta per i prezzi in suo possesso o richiedere offerta scritta per la quotazione di articoli nuovi. I prezzi si intendono IVA esclusa.

Prices

"Rivit Srl" will invoice the prices as in force at the moment of the shipment. Pricelists can be updated without notice, according to the market situation. Correct and valid prices are always stated in the 'order confirmation'. Quoted prices are always VAT excluded.

Confezioni - quantità minime

Nelle ordinazioni si prega di attenersi alle confezioni indicate per ogni articolo nel presente catalogo. Non si accettano ordini per quantitativi inferiori alle confezioni minime. La "Rivit Srl" si riserva la facoltà di adeguare automaticamente gli ordini non corrispondenti alle quantità minime senza richiedere l'autorizzazione del cliente. Si richiede un contributo minimo per le spese di imballo.

Packaging - Minimum quantities

When preparing your orders, please check on this catalogue the standard packaging of the items of your interest. "Rivit Srl" will not accept orders for smaller quantities than what contained in the minimum packaging. In this case the quantity of the ordered items will be automatically modified according to the minimum quantity, without asking for any authorization from the Customer. For packaging you will be charged a minimum contribution fee.

Fatturato minimo

L'importo minimo di fornitura per spedizione è pari a € 100,00 di imponibile.

Minimum purchase

The minimum purchase value that "Rivit Srl" accepts, is € 100,00.

Rimanenze

Eventuali rimanenze, salvo diversa richiesta da parte del cliente, verranno incluse nelle spedizioni successive.

Balances

If there are no different dispositions from the customer, the balances will be sent with the next shipment.

Spedizioni

Le spedizioni avvengono in porto franco con addebito in fattura con mezzi di trasporto di nostra scelta, salvo i trasporti in porto assegnato (corriere incaricato dal committente) o accordi diversi. La merce viaggia a rischio e pericolo del committente, salvo la responsabilità del vettore ai sensi dell'Art. 1693 c.c. Si richiede un contributo minimo per le spese di imballo.

Shipments

Usually deliveries are ex-works (when the customer uses its carrier). They can also be ex-works with charge of the transport costs on the invoice (when "Rivit Srl" chooses the carrier), or by other agreed solutions. Transportation title and risks are on the Customer, apart from carrier's responsibilities stated in Art. 1693 C.C.

Termini di consegna

I termini di consegna non sono da considerarsi tassativi, ma sono subordinati alla disponibilità dei prodotti. Eventuali ritardi nelle consegne o riduzioni di forniture per cause non imputabili alla nostra volontà, non pregiudicano la validità del contratto o ordine.

Delivery terms

Delivery dates are not peremptory but they strictly depend on the availability of the goods. Delays in the shipment, or reductions of the forwarded quantities, that do not depend on our will, will not change the commercial value of the contract/order.

Reclami - Resi

Trascorsi 8 giorni dal ricevimento della merce, non si accettano reclami. I reclami di qualunque natura non sospendono l'obbligo di effettuare i pagamenti secondo le forme convenute. I resi di nostro materiale dovuti a cause diverse da problemi qualitativi, difformità rispetto a quanto ordinato, nostro errore di spedizione, errore del nostro rappresentante, devono essere preventivamente autorizzati dal responsabile commerciale, previo colloquio telefonico o richiesta scritta.

Il reso normalmente viene accettato solo per:

- Materiale inviato in porto franco e con documento di trasporto riportante i riferimenti alla nostra fattura di vendita e/o DDT.
- Materiale confezionato ancora nelle nostre scatole ancora etichettate per permetterci la rintracciabilità.
- Materiale standard (presente a catalogo) e quindi non prodotto appositamente per il cliente (prodotto speciale) o approntato per le esigenze di quest'ultimo (prodotto extra-gamma).

Inoltre in ogni reso viene applicata una percentuale di addebito del 30% quale concorso alle attività di controllo e gestione del reso, comunque con un importo minimo di addebito pari a 50 €. Non verranno accettati colli non integri o manomessi. In mancanza di questi requisiti il reso sarà rispedito al mittente con spese di trasporto a suo carico.

Complaints - Goods returns

After 8 days of having received the goods no complaints will be accepted. A complaint does not suspend the customer's payment obligations according to the agreed form. Returned goods of our products due to causes other than qualitative problems differences from the order, our shipping error, our agent error, must be authorized in advance by the sales manager, after phone conversation or written request. The return is normally accepted only in case of:

- Material sent prepaid freight and with transport note showing the references to our sales invoice and/or DDT.
- Material still packaged in our boxes and still labeled to allow us the traceability.
- Standard material (in the catalogue) not manufactured specifically for the customer (special product) or prepared on his demands (out of range product).

To every returned good is applied a charge rate of 30% as a concurrence to control activities of the returned goods, with a minimum charge of € 50. Damaged packages will not be accepted. Without these requirements, the returned goods will be returned to sender with transportation charges at his own expense.

Prodotti in garanzia

Vengono sostituiti gratuitamente, previa verifica, gli attrezzi difettosi, ma non quelli che presentano inconvenienti dovuti al normale logorio, all'errato uso o evidentemente manomessi. La sostituzione dei prodotti deve essere effettuata franco nostra sede, avendo cura di indicare nel documento di accompagnamento gli estremi del nostro documento di trasporto, il codice, la descrizione dell'articolo fornito, la segnalazione chiara del difetto e allegando la fotocopia di eventuale DDT/fattura da noi emessa che comprovi una precedente riparazione. La spedizione di tutti gli articoli riparati avviene in porto franco con addebito in fattura o porto assegnato (vettore del cliente).

Warranty

Defective goods covered by warranty can be replaced free of charge, subject to prior inspection. On the other hand worn-out, misused and altered tools will not be replaced. Carriage for goods return will always be on customer's charge. In the shipping document the Customer must clearly specify the number and the date of our previous shipping document/invoice, item code, item description, detailed explanation of the defect and shall attach any copy of documents proving previous reparations.

The delivery of any repaired product is ex-works with charge of the transport costs on the invoice or ex-works (Customer's carrier).

Pagamenti

I pagamenti devono essere concordati con il Nostro ufficio vendite. Non sono consentiti arrotondamenti o trattenute arbitrarie sugli importi dovuti. L'insolvenza di R.I.B.A. e ogni ritardato pagamento genera l'addebito di spese e di interessi di mora. La consegna della merce non trasferisce la proprietà della stessa, se non quando è avvenuto il totale pagamento ai sensi dell'art. 1523 C.C.

Payments

Payments must be agreed with our sales department. Rounding offs or arbitrary reductions are not allowed. Each payment delay leads to additional costs and interests. Goods delivery does not transfer the property of the material to the Customer until the complete payment is carried out (Art. 1523 c.c.).

Foro competente

Per ogni controversia è solo competente il Foro di Bologna.

Place of jurisdiction

All disputes arising from, or in connection with any commercial matter shall be settled exclusively by the Court of Bologna (Italy).

I cataloghi della Rivit srl sono indicativi, ci riserviamo il diritto di modificare le specifiche e i prezzi di qualsiasi prodotto senza alcun obbligo di preavviso al Cliente.

Rivit catalogs are indicative, we reserve the right to change the specification and the prices of any product without prior notice.

Rivit
(ufficio vendite)
(sales department)



COME RAGGIUNGERCI

HOW TO REACH US

Legenda caselli autostradali

Motorway tollbooths

- R1** Bologna - Borgo panigale
- R2** Bologna - Casalecchio
- R3** Bologna - Arcoveggio
- R4** Bologna - Fiera
- R5** Bologna - San Lazzaro

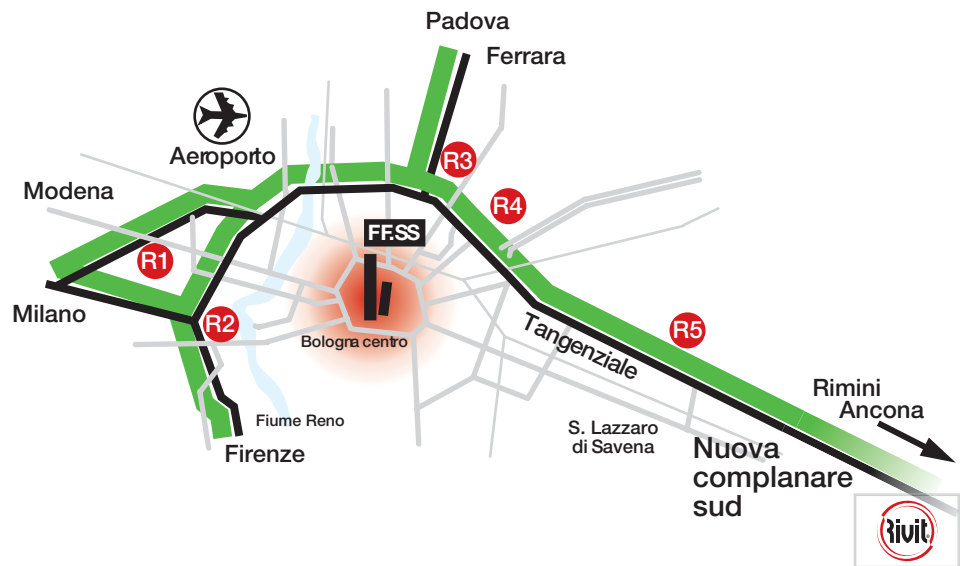

Per chi si trova in tangenziale a Bologna

Prendere la tangenziale direzione Ancona; a San Lazzaro, ultima uscita tangenziale (n°13) non uscire ma proseguire per la nuova complanare sud.

Tenere la destra (attenzione a non prendere l'autostrada), sempre dritto fino a quando la strada non finisce e ci troviamo davanti a una rotonda.

A questo punto proseguire dritto, imboccando via della Grafica, fino a quando non incrociate via Marconi. Arrivati.

From the Bologna "tangenziale" ring (freeway).

Take the "tangenziale" ring, Ancona-San Lazzaro direction. Carry on the "tangenziale" until you reach the very last exit indicating the "Complanare Sud". Attention! It is exactly on the right side of the entrance of the motorway: do not enter the motorway but turn right on the "Complanare Sud". Carry on until you reach the end of the "Complanare Sud"; you will find yourself in a roundabout. Leave the roundabout for 'Via della Grafica', which is straight away, and go ahead until you reach via Marconi. You arrived: Rivit is on your right.



ATTENZIONE: Impostazioni navigatore: Ozzano - Via della Grafica, 1.
NOTICE: GPS system settings: Ozzano - Via della Grafica, 1.



RIVIT TAPPA CENTRALE PER VISITARE L'ITALIA

RIVIT IS YOUR CENTRAL STOP WHEN VISITING ITALY



RIVENDITORE | DEALER

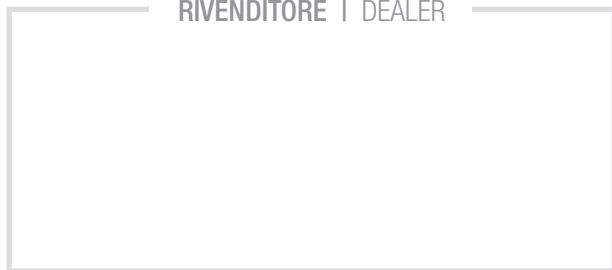

RIVIT.IT FASTENERS & TOOLS DAL / SINCE 1973



SEDE ITALIA | HEADQUARTERS

RIVIT srl | Via Marconi, 20 loc. Ponte Rizzoli | 40064 Ozzano dell'Emilia (BO) | Italy
T. +39 051 4171111 | F. +39 051 4171129 | rivit@rivit.it | www.rivit.it

SEDE INDIA | SUBSIDIARY

RIVIT INDIA FASTENERS pvt ltd | 135 Ganapathy Colony 3rd Street |
St.Thomas Mount | Chennai 600016 | Tamil Nadu | India
T. +91 44 42850250 | F. +91 44 42850023 | rivitindia@rivit.in | www.rivit.in

SEDE MAROCCO | SUBSIDIARY

RIVIT MAROC sarl au | Av. Hassan II nr. 2 km 17 | 12010 Temara | Maroc
T. +212 537 611157 | rivit@rivit.ma

