

DIGITAL INDICATING CONTROLLER

ACD-13A, ACR-13A

INSTRUCTION MANUAL

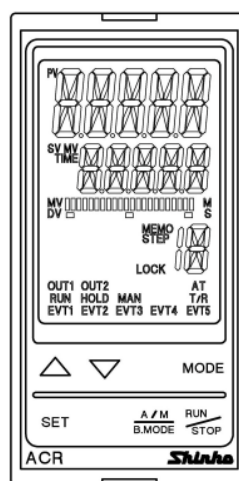
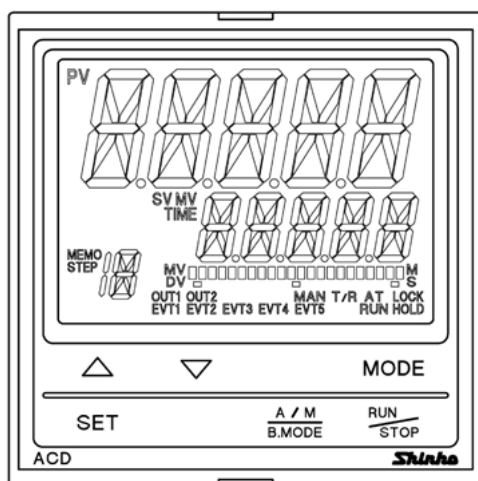

Shinko

Preface

Thank you for the purchase of our Digital indicating controller ACD-13A or ACR-13A. This manual contains instructions for the mounting, functions, operations and notes when operating the ACD-13A or ACR-13A. To prevent accidents arising from the misuse of this controller, please ensure the operator receives this manual.

Notes

- This instrument should be used in accordance with the specifications described in the manual. If it is not used according to the specifications, it may malfunction or cause a fire.
- Be sure to follow the warnings, cautions and notices. If they are not observed, serious injury or malfunction may occur.
- Specifications of the instrument and the contents of this instruction manual are subject to change without notice.
- Care has been taken to ensure that the contents of this instruction manual are correct, but if there are any doubts, mistakes or questions, please inform our sales department.
- This instrument is designed to be installed through a control panel. If it is not, measures must be taken to ensure that the operator cannot touch power terminals or other high voltage sections.
- Any unauthorized transfer or copying of this document, in part or in whole, is prohibited.
- Shinko Technos CO., LTD. is not liable for any damage or secondary damage(s) incurred as a result of using this product, including any indirect damage.

SAFETY PRECAUTIONS (Be sure to read these precautions before using our products.)

The safety precautions are classified into categories: "Warning" and "Caution".

Depending on the circumstances, procedures indicated by  Caution may cause serious results, so be sure to follow the directions for usage.



Warning

Procedures which may lead to dangerous conditions and cause death or serious injury, if not carried out properly.



Caution

Procedures which may lead to dangerous conditions and cause superficial to medium injury or physical damage or may degrade or damage the product, if not carried out properly.



Warning

- To prevent an electric shock or fire, only Shinko or other qualified service personnel may handle the inner assembly.
- To prevent an electric shock, fire or damage to the instrument, parts replacement may only be undertaken by Shinko or other qualified service personnel.



Safety Precautions

- To ensure safe and correct use, thoroughly read and understand this manual before using this instrument.
- This instrument is intended to be used for industrial machinery, machine tools and measuring equipment. Verify correct usage after consulting purpose of use with our agency or main office. (Never use this instrument for medical purposes with which human lives are involved.)
- External protection devices such as protection equipment against excessive temperature rise, etc. must be installed, as malfunction of this product could result in serious damage to the system or injury to personnel. Also proper periodic maintenance is required.
- This instrument must be used under the conditions and environment described in this manual. Shinko Technos Co., Ltd. does not accept liability for any injury, loss of life or damage occurring due to the instrument being used under conditions not otherwise stated in this manual.

Caution with respect to Export Trade Control Ordinance

To avoid this instrument from being used as a component in, or as being utilized in the manufacture of weapons of mass destruction (i.e. military applications, military equipment, etc.), please investigate the end users and the final use of this instrument.

In the case of resale, ensure that this instrument is not illegally exported.

1. Installation precautions



Caution

This instrument is intended to be used under the following environmental conditions (IEC61010-1):

Overvoltage category II, Pollution degree 2

Ensure the mounting location corresponds to the following conditions:

- A minimum of dust, and an absence of corrosive gases
- No flammable, explosive gases
- No mechanical vibrations or shocks
- No exposure to direct sunlight, an ambient temperature of 0 to 50°C (32 to 122°F) that does not change rapidly, and no icing
- An ambient non-condensing humidity of 35 to 85%RH
- No large capacity electromagnetic switches or cables through which large current is flowing.
- No water, oil or chemicals or where the vapors of these substances can come into direct contact with the unit
- Take note that the ambient temperature of this unit must not exceed 50°C (122°F) if mounted through the control panel. Otherwise the life of electronic components (especially electrolytic capacitors) may be shortened.

Note: Avoid setting this instrument directly on or near flammable material even though the case of this instrument is made of flame-resistant resin.

2. Wiring precautions



Caution

- Do not leave bits of wire in the instrument, because they could cause a fire or malfunction.
- Use the solderless terminal with an insulation sleeve in which the M3 screw fits when wiring the instrument.
- The terminal block of this instrument is designed to be wired from the left side. The lead wire must be inserted from the left side of the terminal, and fastened with the terminal screw.
- Tighten the terminal screw to within the specified torque. If excessive force is applied to the screw when tightening, the terminal screw or case may be damaged.
- This instrument does not have a built-in power switch, circuit breaker or fuse. It is necessary to install them near the controller.
(Recommended fuse: Time-lag fuse, rated voltage 250V AC, rated current 2A)
- For a 24V AC/DC power source, do not confuse polarity when using direct current (DC).
- Do not apply a commercial power source to the sensor which is connected to the input terminal nor allow the power source to come into contact with the sensor.
- Use a thermocouple and compensating lead wire according to the sensor input specifications of this controller.
- Use the 3-wire RTD according to the sensor input specifications of this controller.
- For voltage input, (+) side input terminal number differs depending on its range as follows.
(+) side input terminal number of 0-5V DC, 1-5V DC, 0-10V DC: 16
(+) side input terminal number of 0-10mV DC, -10-10mV DC, 0-50mV DC, 0-100mV DC, 0-1V DC: 18
- When using a relay contact output type, externally use a relay according to the capacity of the load to protect the built-in relay contact.
- When wiring, keep input wires (thermocouple, RTD, etc.) away from AC sources or load wires to avoid external interference.

3. Operation and maintenance precautions



Caution

- It is recommended that auto-tuning be performed on the trial run.
- Do not touch live terminals. This may cause electric shock or problems in operation.
- Turn the power supply to the instrument OFF when retightening the terminal and cleaning.
Working or touching the terminal with the power switched ON may result in severe injury or death due to Electric Shock.
- Use a soft, dry cloth when cleaning the instrument.
(Alcohol based substances may tarnish or deface the unit)
- As the display section is vulnerable, do not strike or scratch it with a hard object or press hard on them

Abbreviations used in this manual

Symbol	Term
PV	Process variable
SV	Desired value
MV	Output manipulated variable
DV	Deviation
AT	Auto-tuning
CT	Current transformer (for Heater burnout alarm option)

Characters used in this manual:

Indication	-	0	1	2	3	4	5	6	7	8	9	°C	°F
Number, °C/°F	-1	0	1	2	3	4	5	6	7	8	9	°C	°F
Indication	A	B	C	D	E	F	G	H	I	J	K	L	M
Alphabet	A	B	C	D	E	F	G	H	I	J	K	L	M
Indication	N	O	P	Q	R	S	T	U	V	W	X	Y	Z
Alphabet	N	O	P	Q	R	S	T	U	V	W	X	Y	Z

--- CONTENTS ---

1. Model	
1.1 Model	7
1.2 How to read the model label	8
2. Name and functions	9
3. Mounting to the control panel	
3.1 External dimensions (Scale: mm)	12
3.2 Panel cutout (Scale: mm)	13
3.3 CT external dimensions (Scale: mm)	13
3.4 Mounting and removal to/from the control panel	14
4. Wiring	
4.1 Terminal arrangement	15
4.2 Lead wire solderless terminal	16
4.3 Wiring example	17
5. Outline of key operation and setting groups	19
6. Operation flowchart	20
7. Setup	25
7.1 Turn the power supply to the unit ON.	27
7.2 Basic operation of settings	27
7.3 Engineering group	28
8. Settings	
8.1 Simplified setting method	52
8.1.1 SV setting mode	52
8.1.2 Event setting mode	52
8.1.3 PID setting mode	56
8.2 Group selection	58
8.2.1 SV, Event group (for fixed value control)	58
8.2.2 Program pattern group (for program control)	61
8.2.3 PID group	65
8.2.4 AT group	67
9. Operation	
9.1 Starting operation	68
9.2 Control output OFF function	71
9.3 Switching Auto/Manual control	72
9.4 Indicating MV and remaining step time (program control)	72
9.5 AT/Auto-reset Perform, AT Cancel	72
9.6 Using Event output as a High/Low limits independent alarm	74
9.7 Set value memory function	76
10. Auto-reset	77
11. Auto-tuning	77
12. Action explanation	
12.1 OUT1 action	79
12.2 OUT1 ON/OFF action	80
12.3 Alarm action	81

12.4 Heater burnout alarm action -----	83
12.5 OUT2(Heating/Cooling control) action -----	84
12.6 OUT2 (Heating/Cooling control) action (when setting dead band) -----	85
12.7 OUT2 (Heating/Cooling control) action (when setting overlap band) -----	86
13. Specifications	
13.1 Standard specifications -----	87
13.2 Optional specifications -----	93
14. Trouble shooting	
14.1 Indication -----	97
14.2 Key operation -----	98
14.3 Control -----	99
15 Character tables -----	100

1. Model

1.1 Model

ACD-1 3 A - <input type="checkbox"/> / M <input type="checkbox"/> , <input type="checkbox"/> <input type="checkbox"/> <input type="checkbox"/>		ACD-13A (W96 x H96 x D100mm)	
ACR-1 3 A - <input type="checkbox"/> / M <input type="checkbox"/> , <input type="checkbox"/> <input type="checkbox"/> <input type="checkbox"/>		ACR-13A (W48 x H96 x D100mm)	
Control action	3		PID
Event output EVT1, EVT2	A		Selectable by front keypad (*1)
Control output (OUT1)	R		Relay contact: 1a1b
	S		Non-contact voltage(for SSR drive): 12V DC± 15%
	A		DC current: 4-20mA DC
Input	M		Multi-range (*2)
Supply voltage			100 to 240V AC (standard)
	1		24V AC/DC (*3)
Options (Multiple options selectable)	EI		Event input
	A3		Event output (EVT1 to EVT3)
	A5		Event output (EVT4, EVT5)
	W	Single-phase	Heater burnout alarm (*4)
	W3	3-phase	
	DR	Relay contact: 1a	Heating/Cooling control output (OUT2)
	DS	Non-contact voltage (for SSR drive): 12V DC± 15%	
	DA	DC current: 4 to 20mA DC	
	C	RS-232C	Serial communication
	C5	RS-485	
	EA1	4-20mA DC	External setting input
	EA2	0-20mA DC	
	EV1	0-1V DC	
	EV2	1-5V DC	
	TA1	4-20mA DC	Transmission output
	TV1	0-1V DC	
P		Insulated power output	

(*1) 13 types of alarm action (including No event) and Energized/De-energized, Timer output, Heater burnout alarm output option, Loop break alarm output, Time signal output, Output during AT or Pattern end output can be selected by front keypad.

(*2) An input type can be selected by front keypad from; Thermocouple, RTD, DC current and DC voltage.

(*3) Supply voltage 100 to 240V AC is standard. When ordering 24V AC/DC, enter "1" after the input code.

(*4) The rated current 20A and 100A for single-phase and 3-phase can be selected by front keypad.

1.2 How to read the model label

The model label is attached to the left side of the case.

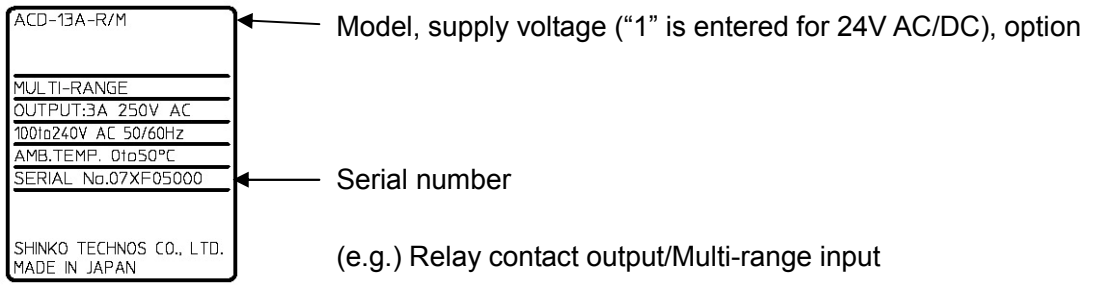

(Fig. 1.2-1)

2. Name and functions

ACD-13A

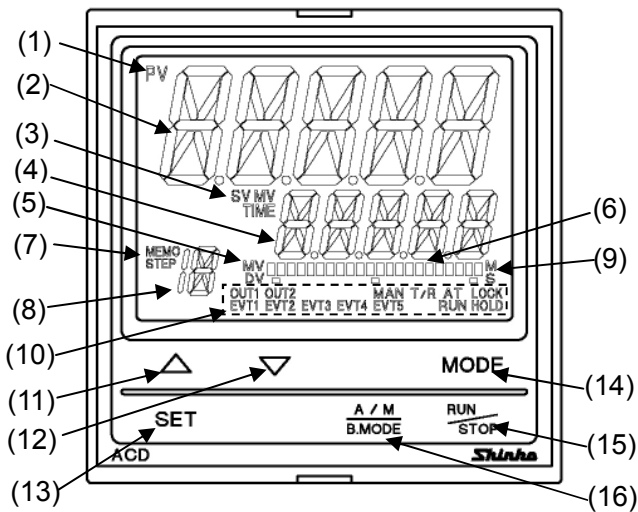

ACR-13A

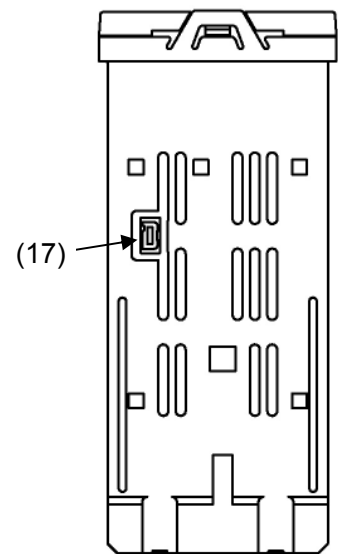
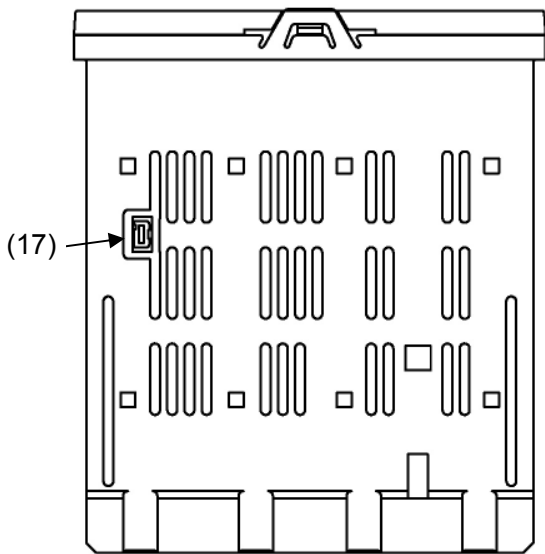
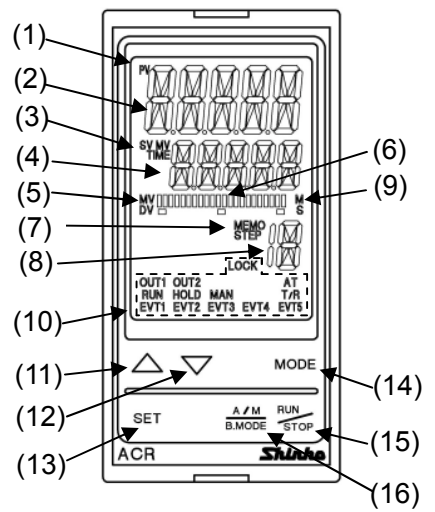

(Fig. 2-1)

Displays

(1) PV indicator

Lights when PV is indicated in the PV/SV display mode.

(2) PV display

Indicates the PV or setting characters in the setting mode.

(3) SV/MV/TIME indicator

SV : Lights when SV is indicated in the PV/SV display mode.

MV : Lights when MV is indicated in the PV/SV display mode.

TIME: Lights when remaining step time (program control) is indicated in the PV/SV display mode.

(4) SV/MV/TIME display

Indicates the SV, MV, remaining step time (program control) or set values in each setting mode.

(5) MV/DV indicator

MV: Lights when MV is indicated on the bar graph.

DV: Lights when DV (deviation) is indicated on the bar graph.

(6) MV/DV bar graph

MV or DV (deviation) is indicated on a bar graph.

(7) MEMO/STEP indicator

MEMO : Lights when a Set value memory number is indicated.

STEP : Lights when a step number is indicated during program control.

Flashes during Wait.

(8) MEMO/STEP display

Indicates the Set value memory number or step number (program control).

(9) M/S indicator

M: Lights when step time unit "Hour:Minute" is selected in the program control .

S: Lights when step time unit "Minute:Second" is selected in the program control.

(10) Action indicators

OUT1 : Lights when control output (OUT1) is ON.

For DC current output type, flashes corresponding to the MV in 0.125 second cycles.

OUT2 : Lights when control output OUT2 (D□ option) is ON.

For DC current output type, flashes corresponding to the MV in 0.125 second cycles.

EVT1 : Lights when EVT1 (Event 1) output occurs.

EVT2 : Lights when EVT2 (Event 2) output occurs.

EVT3 : Lights when EVT3 (Event 3) output occurs.

EVT4 : Lights when EVT4 (Event 4) output occurs.

EVT5 : Lights when EVT5 (Event 5) output occurs.

MAN : Lights during manual control.

T/R : Lights during Serial communication (C, C5 option) [TX (transmitting) output].

AT : Flashes while AT (auto-tuning) or auto-reset is performing.

LOCK : Lights when Set value Lock 1, Lock 2, Lock 3 or Lock 4 is selected.

RUN : Lights while program is running.

HOLD : Flashes while program is on hold (suspended).

Key operations

(11) △ Increase key : Increases the numeric value.

If this key is pressed for 1sec during program operation (RUN), the unit proceeds to the next step. (This is an Advance function.)

(12) ▽ Decrease key : Decreases the numeric value.

(13) SET key

Switches setting groups.

Switches step numbers in the program group.

Switches Set value memory numbers in the "SV, Event group".

Switches block numbers in the PID group.

(14) MODE key

Selects the setting mode, and registers the set value.

To register the set (selected) value, press this key.

(15) RUN/STOP key

For Fixed value control, the PV/SV display mode or standby mode can be switched by pressing this key for 1sec.

In the standby mode, pressing this key turns all outputs OFF as when the power supply is turned off.

In the program mode, control RUNS/STOPS.

In the standby mode, pressing this key RUNS program control.

Program control STOPS by pressing this key for 1sec during program operation (RUN).

(16) A/M B.MODE key

Switches Auto/Manual control.

If this key is pressed during the setting mode, the unit reverts to the previous group or mode.

Case**(17) Console connector**

By connecting to the USB communication cable (CMB-001, sold separately), the following operations can be conducted from an external computer using the Console software SWS-AC001M.

- Reading and setting of SV, PID and various set values
- Reading of PV and action status
- Function change

3. Mounting to the control panel

3.1 External dimensions (Scale: mm)

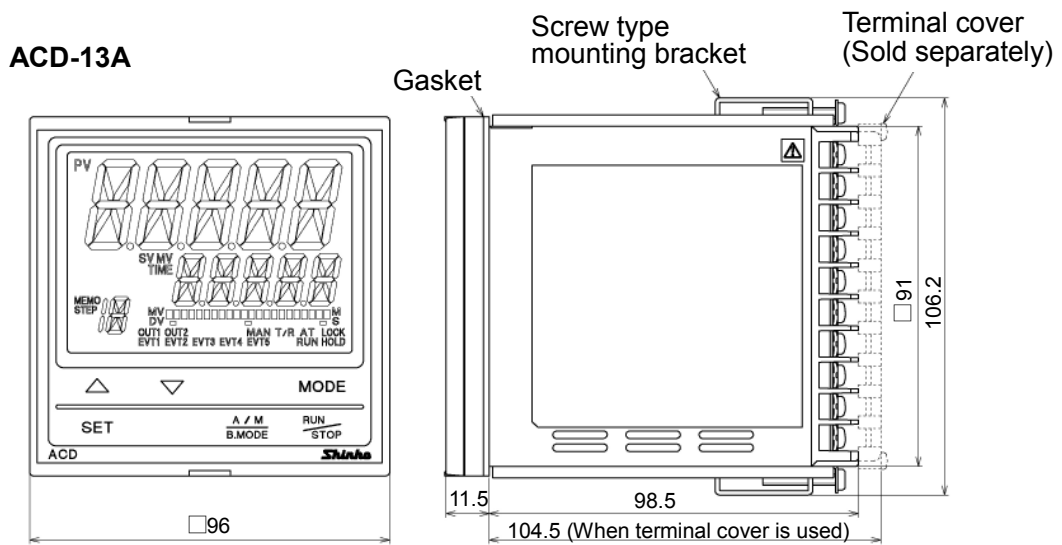

(Fig. 3.1-1)

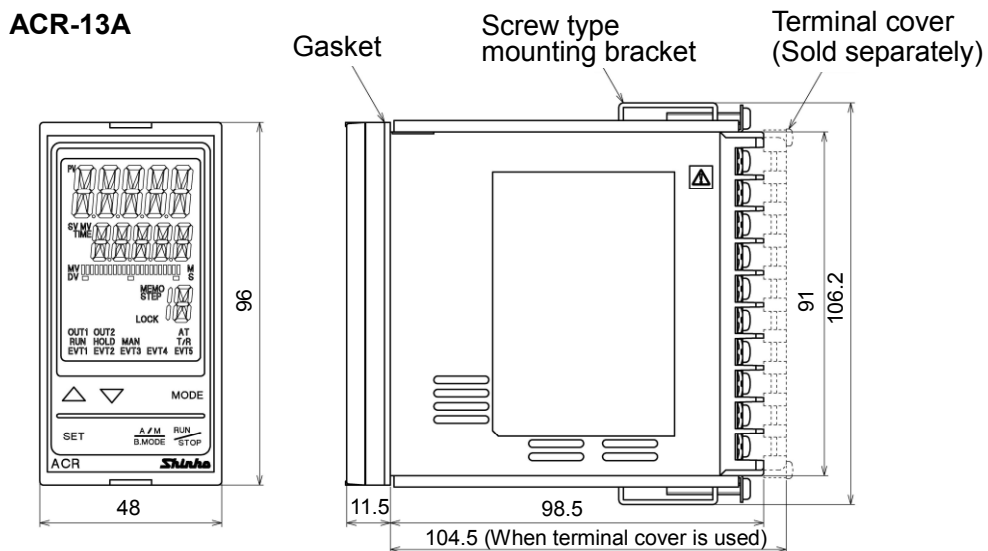

(Fig. 3.1-2)

3.2 Panel cutout (Scale: mm)



Caution

If lateral close mounting is used for the controller, IP66 specification (Dust-proof/ Drip-proof) may be compromised, and all warranties will be invalidated.

ACD-13A

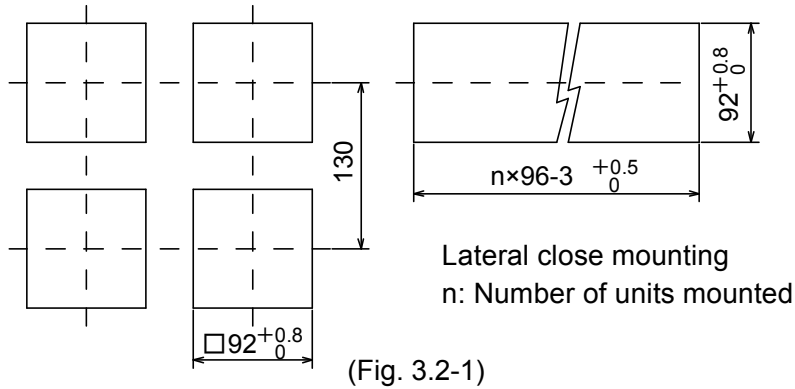

ACR-13A

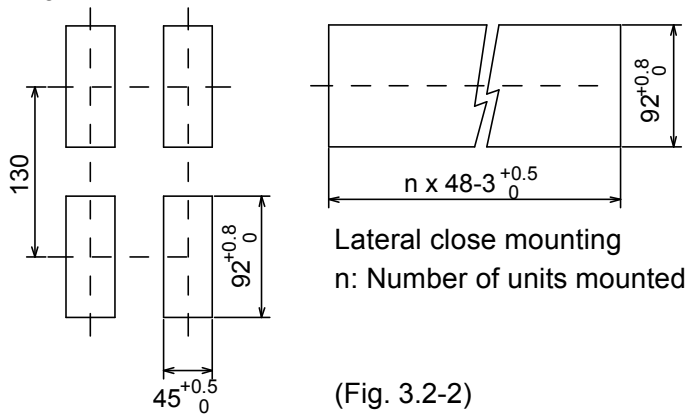

3.3 CT (Current transformer) external dimensions (Scale: mm)

CTL-6S (for 20A)

CTL-12-S36-10L1U (for 100A)

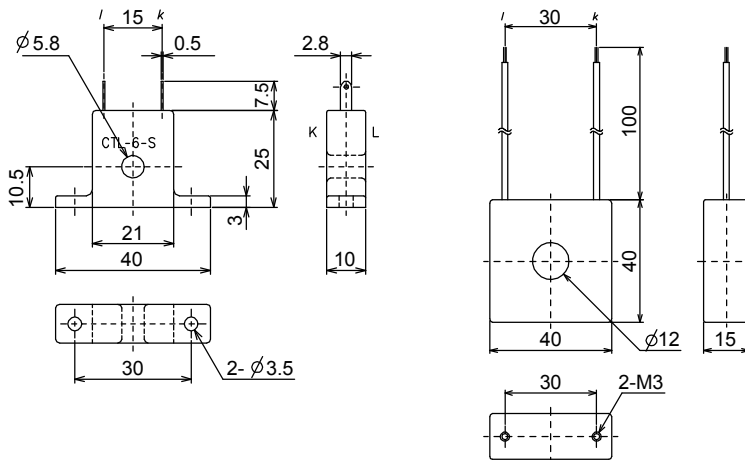

(Fig. 3.3-1)

3.4 Mounting and removal to/from the control panel (Common to ACD-13A, ACR-13A)



Caution

As the case is made of resin, do not use excessive force while screwing in the mounting bracket, or the case or mounting brackets could be damaged. The torque should be approximately 0.12N•m.

How to mount the unit

Mount the controller vertically to the flat, rigid panel to ensure it adheres to the Dust-proof/Drip-proof specification (IP66).

Mountable panel thickness: 1 to 8mm

- (1) Insert the controller from the front side of the panel.
- (2) Attach the mounting brackets by the holes at the top and bottom of the case, and secure the controller in place with the screws.

How to remove the unit

- (1) Turn the power to the unit OFF, and disconnect all wires before removing the unit.
- (2) Loosen the screws of the mounting brackets, and remove the mounting brackets.
- (3) Pull the unit out from the front of the panel

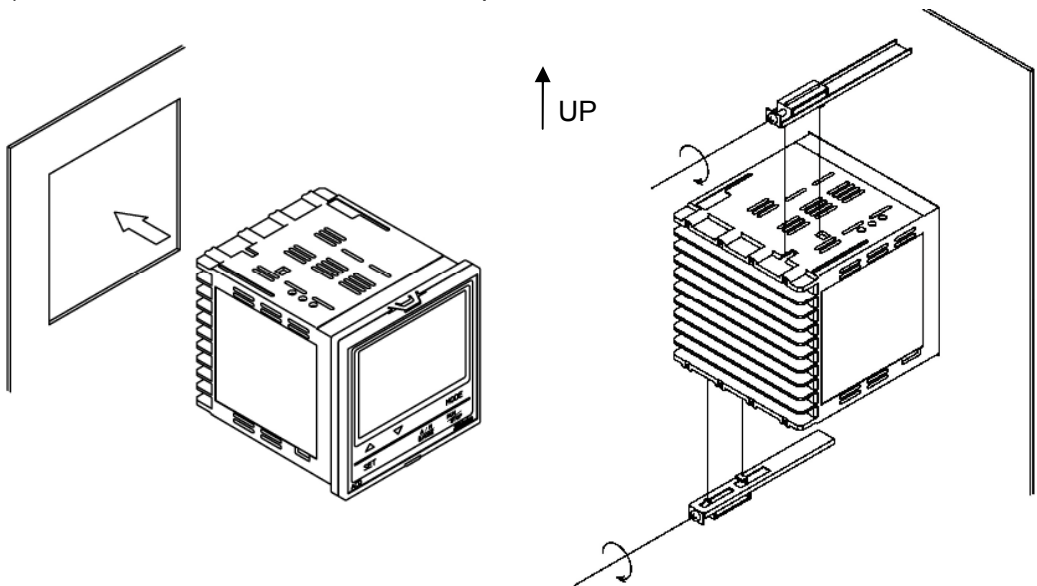

(Fig.3.4-1)

4. Wiring



Warning

Turn the power supply to the instrument OFF before wiring or checking.
Working or touching the terminal with the power switched ON may result in severe injury or death due to Electric Shock.

4.1 Terminal arrangement

ACD-13A

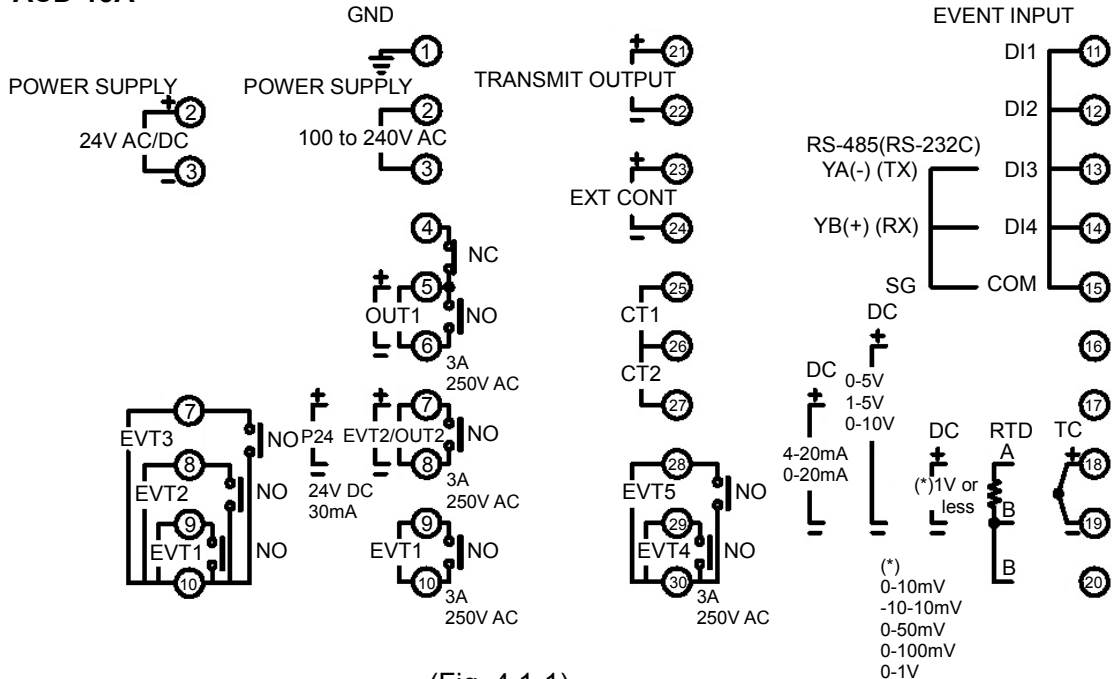

(Fig. 4.1-1)

ACR-13A

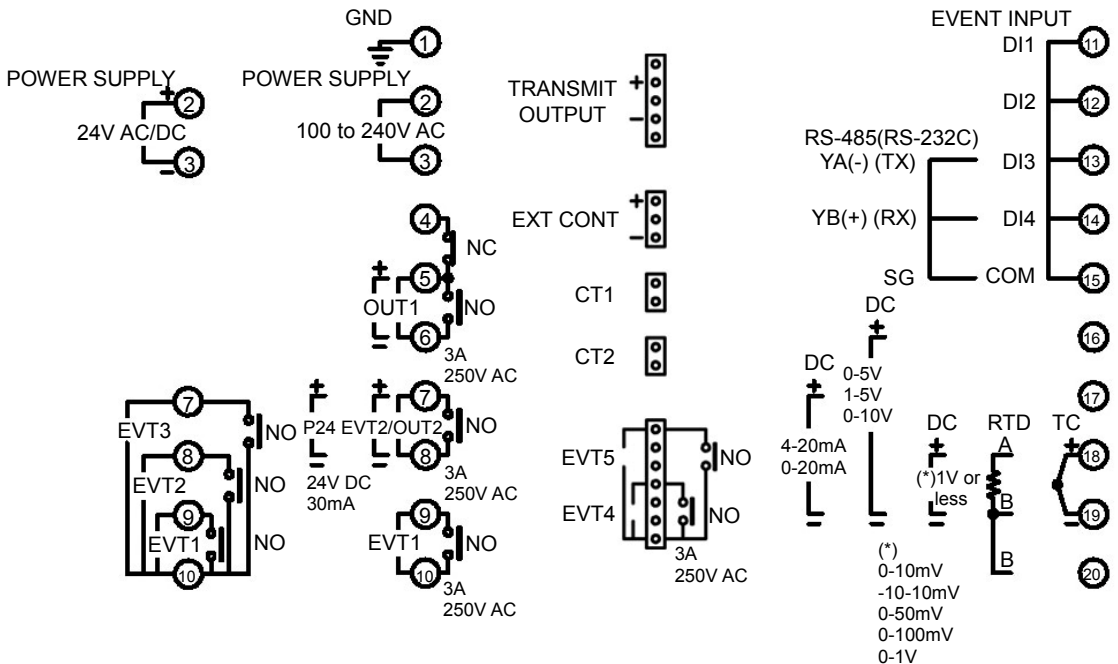

(Fig. 4.1-2)

GND	Ground
POWER SUPPLY	Supply voltage 100-240V AC or 24V AC/DC For a 24V AC/DC power source, do not confuse polarity when using direct current (DC).
OUT1	Control output 1
EVT2/OUT2	EVT2 output or Control output 2 (D□ option)
P24	24V DC insulated power output (P option)
EVT1	EVT1 output
EVT3	EVT3 output (A3 option)
EVENT INPUT	Event input (EI option)
RS-485/RS-232C	Serial communication RS-485(C5 option) or RS-232C(C option)
TC	Thermocouple input
RTD	RTD input
DC	DC voltage, current input (+) side input terminal number of 0- 5V DC, 1-5V DC, 0-10V DC: 16 (+) side input terminal number of 0-10mV DC, -10-10mV DC, 0-50mV DC, 0-100mV DC, 0-1V DC: 18
TRANSMIT OUTPUT	Transmission output (T□□ option)
EXT CONT	External setting input (E□□ option)
CT1	Current transformer input 1 (W, W3 option)
CT2	Current transformer input 2 (W3 option)
EVT4	EVT4 output (A5 option)
EVT5	EVT5 output (A5 option)

4.2 Lead wire solderless terminal

Use a solderless terminal with an insulation sleeve in which an M3 screw fits as shown below.

The torque should be approximately 0.63N·m.

Solderless terminal	Manufacturer	Model	Tightening torque
Y type	Nichifu Terminal Industries CO.,LTD.	TMEV1.25Y-3	0.63N·m
	Japan Solderless Terminal MFG CO.,LTD.	VD1.25-B3A	
Round type	Nichifu Terminal Industries CO.,LTD.	TMEV1.25-3	
	Japan Solderless Terminal MFG CO.,LTD.	V1.25-3	

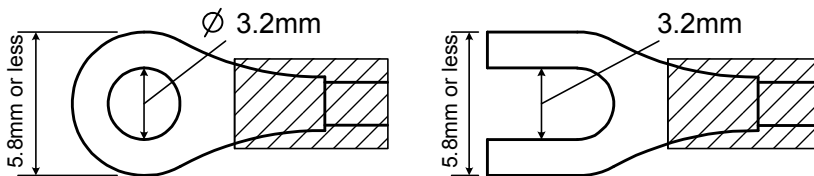

(Fig. 4.2-1)

4.3 Wiring example

ACD-13A-R/M

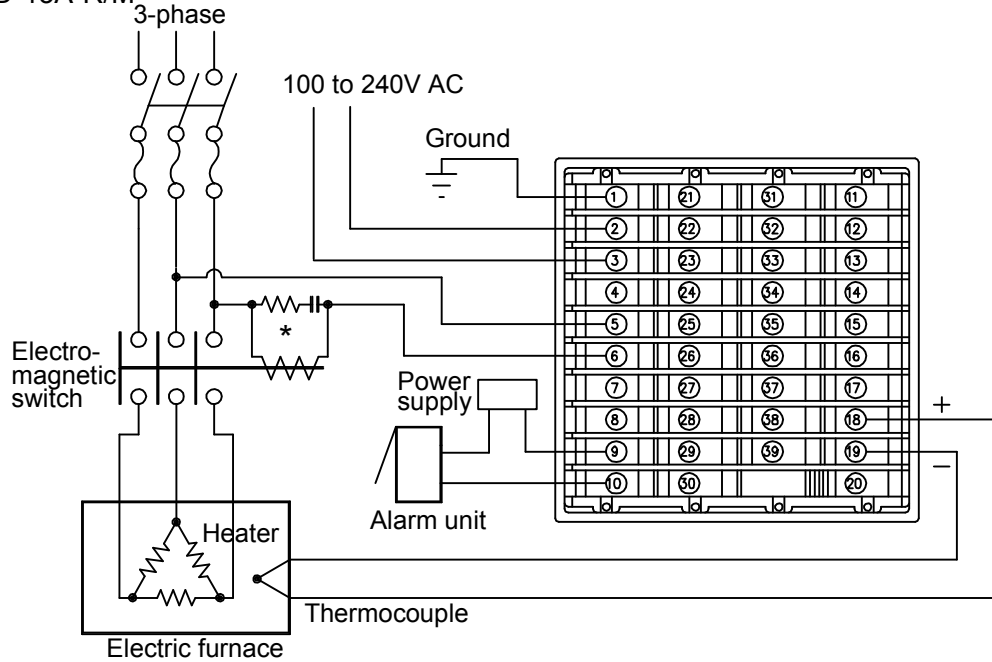

* To prevent the unit from harmful effects of unexpected high level noise, it is recommended that a surge absorber be installed between the electromagnetic switch coils.
(Fig. 4.3-1)

ACD-13A-S/M 1, W

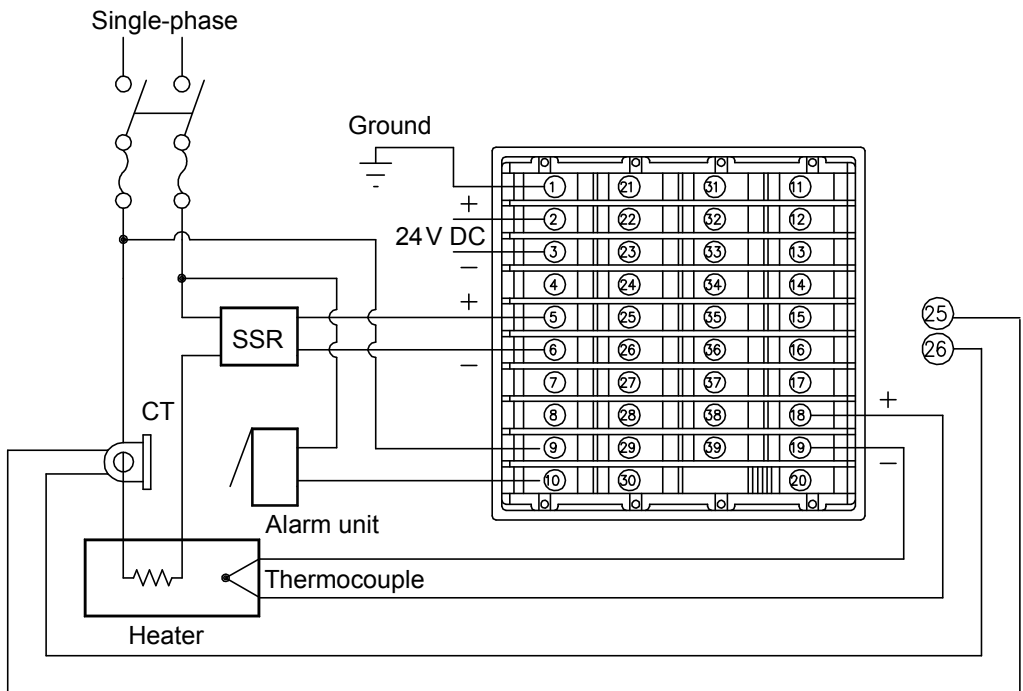

- Four units can be connected in parallel if Shinko SSR (SA-300 series) is used.
- For a 24V AC/DC of power source, do not confuse polarity when using a direct current (DC).

(Fig. 4.3-2)

Current transformer (CT1, CT2) input (W, W3 option)

- (1) This alarm is not usable for detecting current under phase control.
- (2) Use the current transformer (CT) provided, and pass one lead wire of heater circuit into the hole of the CT.
- (3) When wiring, keep CT wire away from AC sources and load wires to avoid the external interference.

[Single-phase heater]

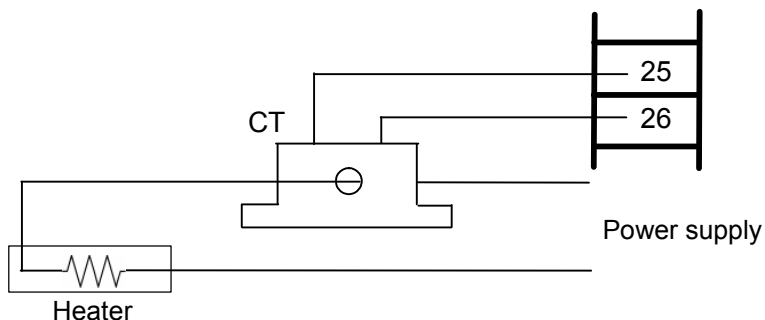

(Fig. 4.3-3)

[Three-phase heater]

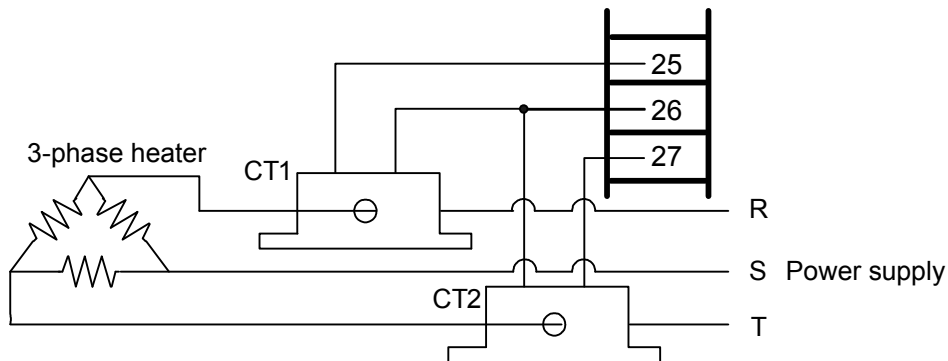

(Fig. 4.3-4)

5. Outline of key operation and setting groups

There are 2 setting methods for this controller; Simplified setting (traditional setting method), Group selection. For each setting method, refer to page 20 and those which follow it.

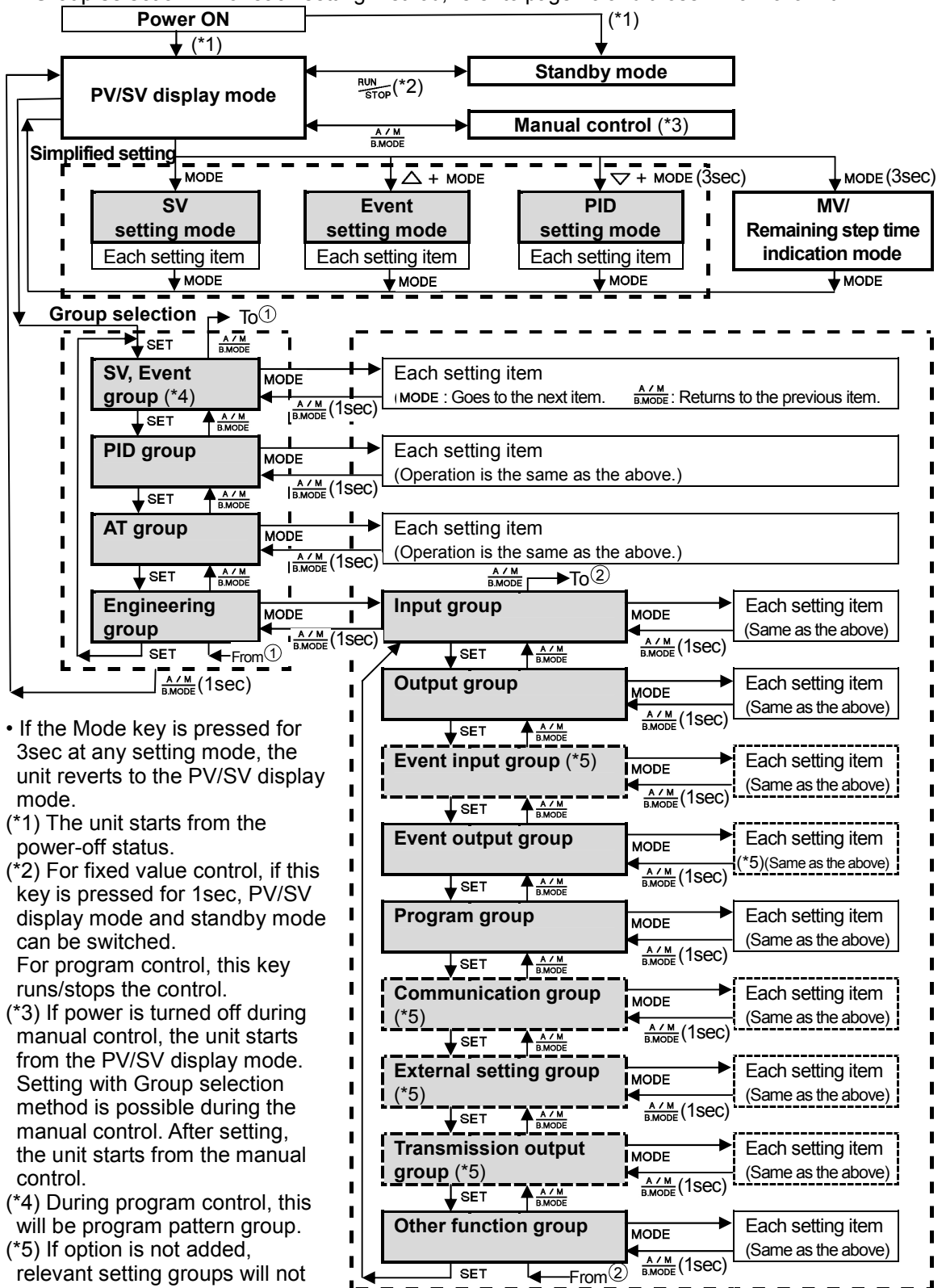

• If the Mode key is pressed for 3sec at any setting mode, the unit reverts to the PV/SV display mode.

(*1) The unit starts from the power-off status.

(*2) For fixed value control, if this key is pressed for 1sec, PV/SV display mode and standby mode can be switched.

For program control, this key runs/stops the control.

(*3) If power is turned off during manual control, the unit starts from the PV/SV display mode. Setting with Group selection method is possible during the manual control. After setting, the unit starts from the manual control.

(*4) During program control, this will be program pattern group.

(*5) If option is not added, relevant setting groups will not be displayed.

6. Operation flowchart

Simplified setting and group selection are explained separately.

All setting items are used for the purpose of explanation, however some items will not be indicated depending on the specification.

6.1 Simplified setting (SV, Event and PID setting mode: Effective for Fixed value control)

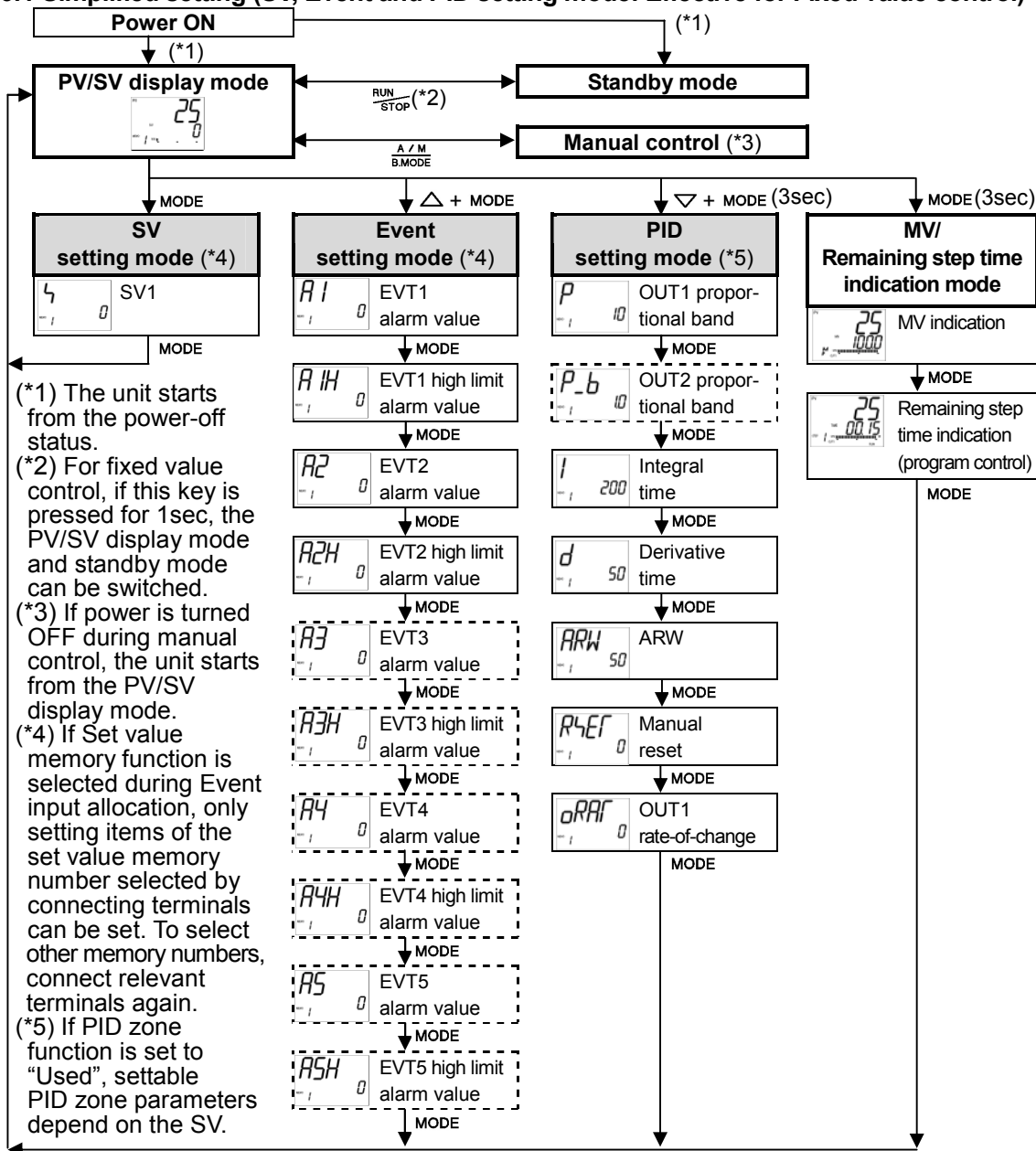

[Key operation]

- ↓MODE : This means that if the MODE key is pressed, the unit proceeds to the next setting mode.
- △ + MODE : Press the MODE key while pressing the △ key.
- ▽ + MODE : Press the MODE key while pressing the ▽ key.
- MODE (3sec): Press the MODE key for 3sec.

[Setting item]

- The PV display indicates setting characters, and the SV display indicates the default value.
- Setting items with dotted lines are optional, and they appear only when the options are added.

6.2 Group selection (for Fixed value control)

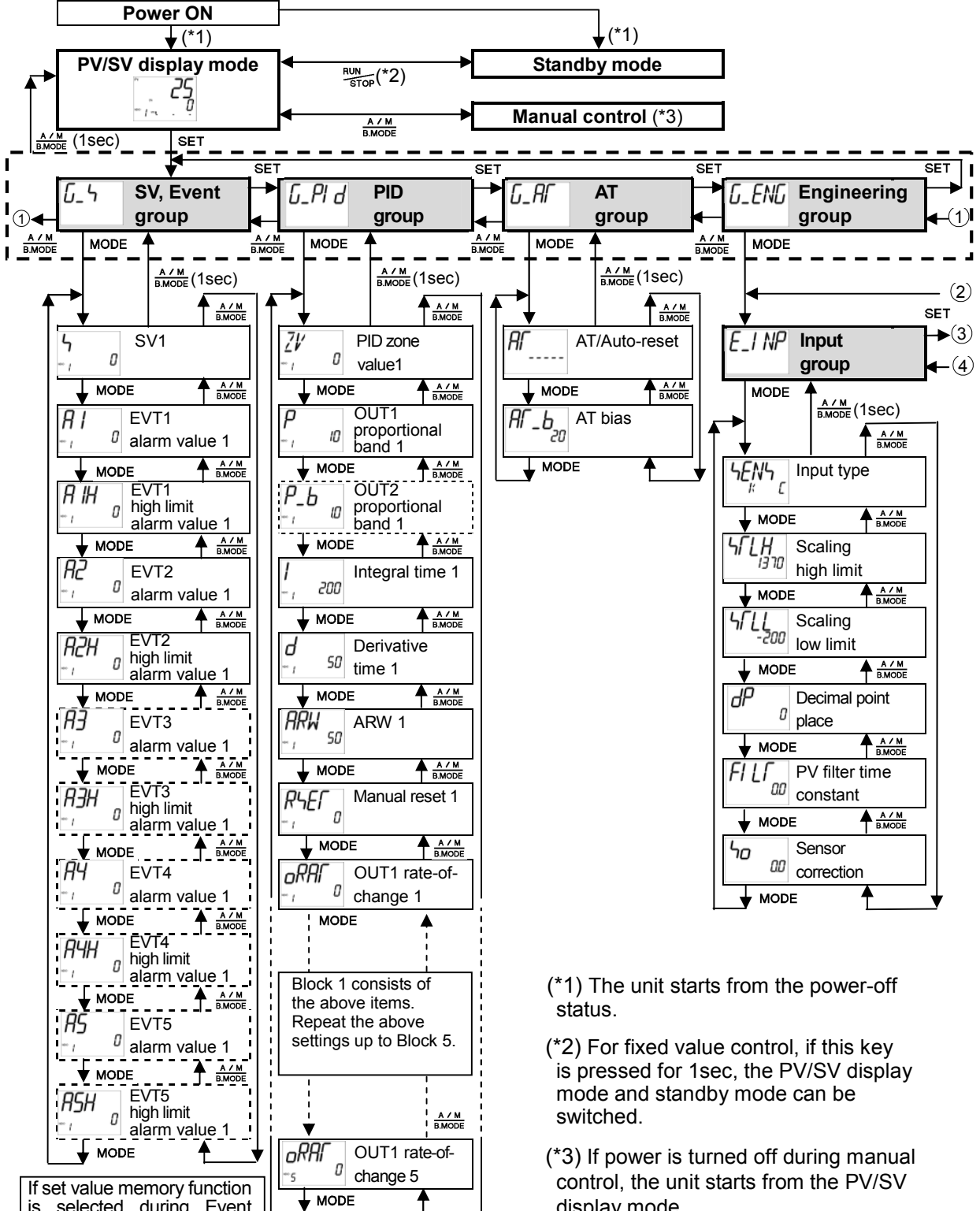

If set value memory function is selected during Event input allocation, only the selected memory number can be set. If EVI1 and EVI2 are set to set value memory function, set value memory numbers will be 1 to 4. (See p.76)

(*1) The unit starts from the power-off status.

(*2) For fixed value control, if this key is pressed for 1sec, the PV/SV display mode and standby mode can be switched.

(*3) If power is turned off during manual control, the unit starts from the PV/SV display mode. Setting using the Group selection method is possible. After setting is complete, the unit starts from the manual control.

[Key operation]

- \downarrow MODE : This means that if the MODE key is pressed, the unit proceeds to the next setting mode.
- Pressing the $\frac{A}{M}$ / $\frac{B}{MODE}$ key for 1sec reverts to the previous setting level.
- If the MODE key is pressed for 3sec at any group or setting item, the unit reverts to the PV/SV display mode.

[Setting item]

- The PV display indicates setting characters, and the SV display indicates the default value.
- Setting items with dotted lines are optional, and they appear only when the options are added.

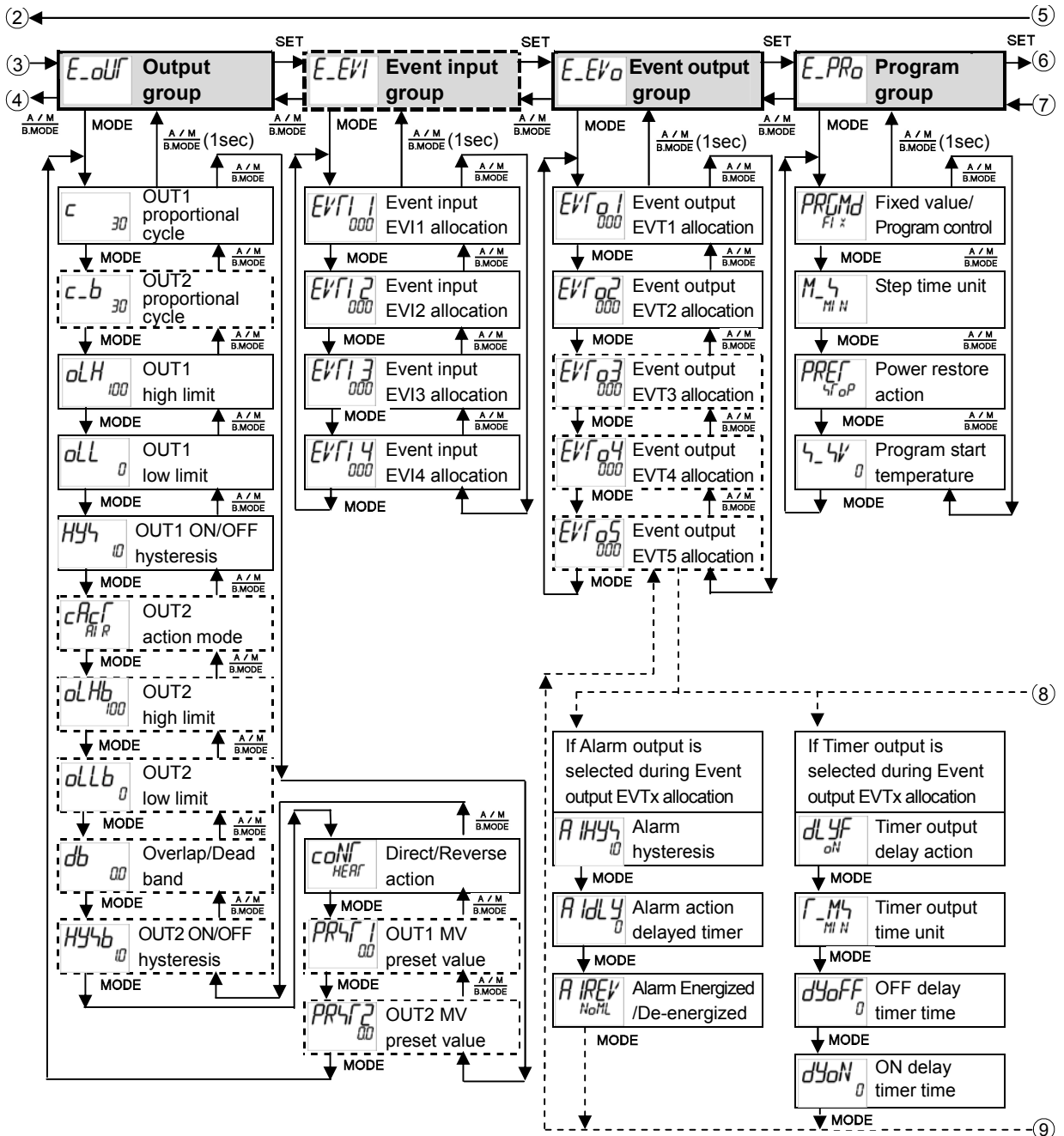

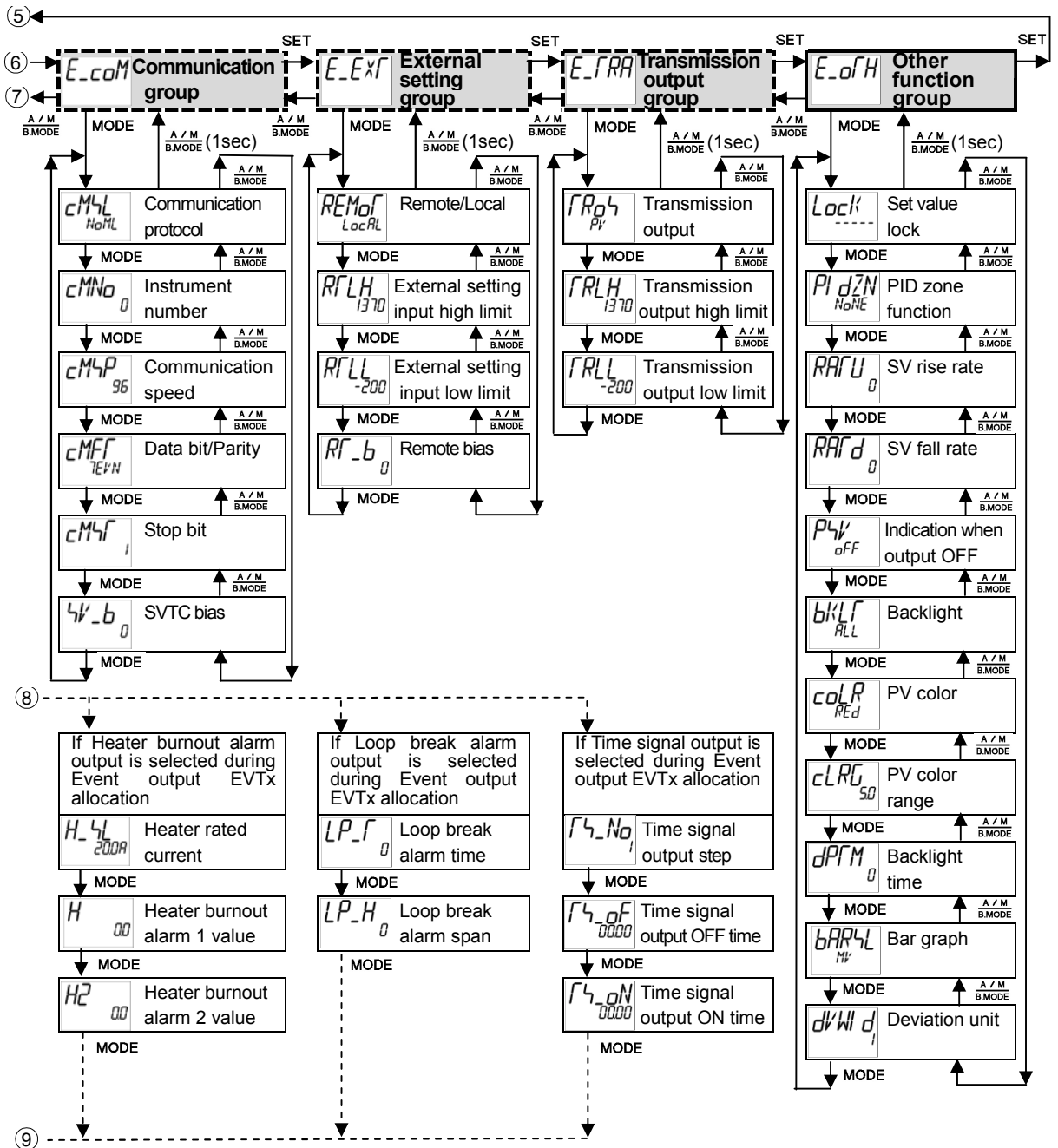

6.3 Group selection (for program control)

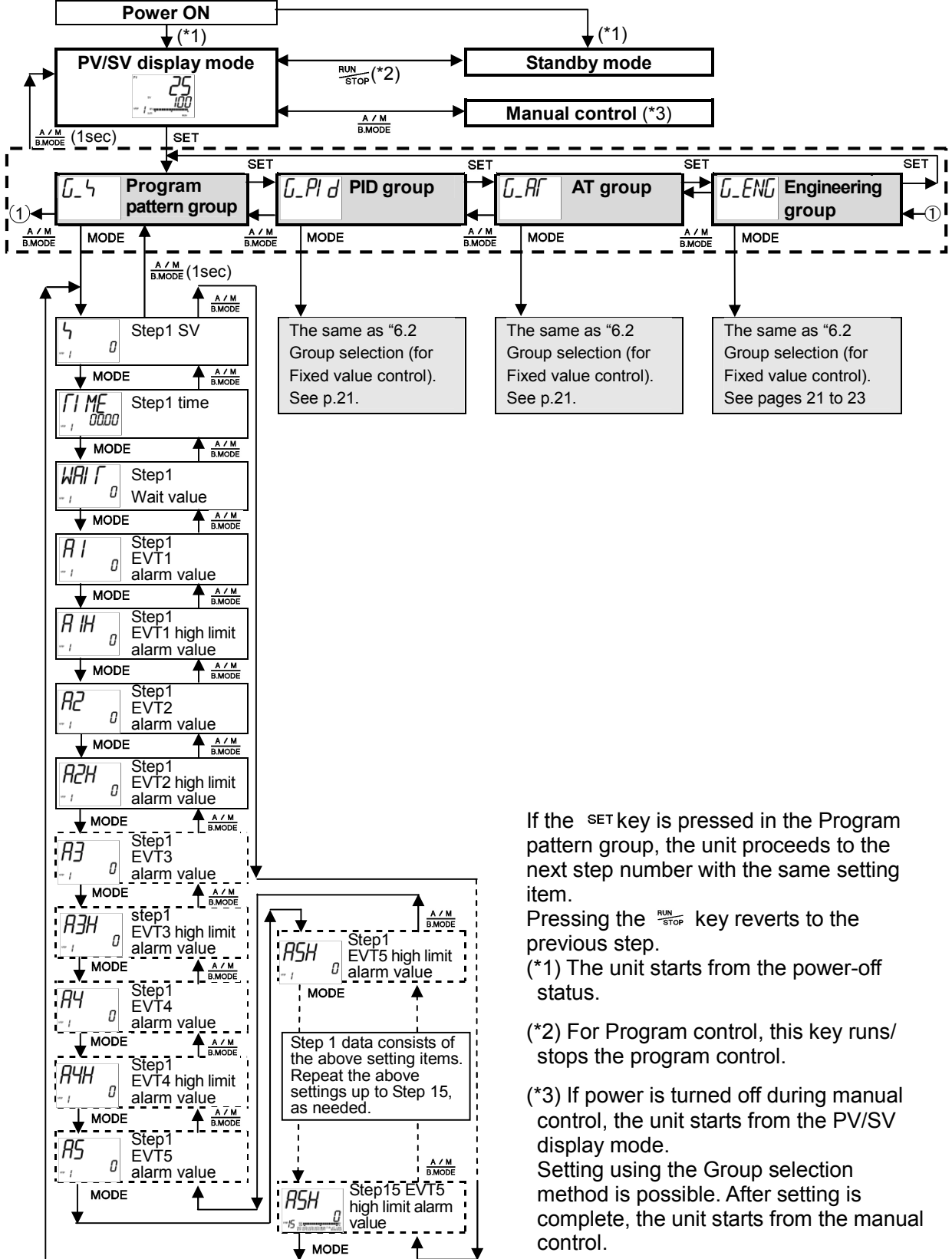

If the **SET** key is pressed in the Program pattern group, the unit proceeds to the next step number with the same setting item.

Pressing the **RUN/STOP** key reverts to the previous step.

(*1) The unit starts from the power-off status.

(*2) For Program control, this key runs/stops the program control.

(*3) If power is turned off during manual control, the unit starts from the PV/SV display mode. Setting using the Group selection method is possible. After setting is complete, the unit starts from the manual control.

7. Setup

Default values of this controller;

Input type : K, -200 to 1370°C

Control action : PID action (with auto-tuning), Reverse action (Heating action)

Event output (EVT1, EVT2): No event

Setup should occur before using this controller, to set the Input type, control action, Event output action, etc. according to the users' conditions.

Setup is conducted in the Engineering group.

The Engineering group consists of; Input group, Output group, Event input group, Event output group, Program group, Communication group, External setting group, Transmission output group and Other function group.

If the users' specification is the same as the default value of the instrument, it is not necessary to set up the controller. Proceed to Chapter "8. Settings".

Default values of the Engineering group

• Input group (pages 28-30)

Setting item	Default value
Input type	K, -200 to 1370°C
Scaling high limit	1370°C
Scaling low limit	-200°C
Decimal point place	No decimal point
PV filter time constant	0.0sec
Sensor correction	0.0°C

• Output group (pages 31-32)

Setting item	Default value
OUT1 proportional cycle	Relay contact output: 30sec Non-contact voltage output: 3sec DC current output: Not available
OUT2 proportional cycle (D□ option)	Relay contact output: 30sec Non-contact voltage output: 3sec DC current output: Not available
OUT1 high limit	100%
OUT1 low limit	0%
OUT1 ON/OFF action hysteresis	1.0°C
OUT2 action mode (D□ option)	Air cooling
OUT2 high limit (D□ option)	100%
OUT2 low limit (D□ option)	0%
Overlap/Dead band (D□ option)	0.0°C
OUT2 ON/OFF action hysteresis (D□ option)	1.0°C
Direct/Reverse control action	Reverse action
OUT1 preset output	0.0%
OUT2 preset output (D□ option)	0.0%

• Event input group (EI option) (pages 33-34)

Setting item	Default value
Event input EVI1 allocation	No event
Event input EVI2 allocation	No event
Event input EVI3 allocation	No event
Event input EVI4 allocation	No event

• **Event output group (pages 35-42)**

Setting item	Default value
Event output EVT1 allocation	No event
Event output EVT2 allocation	No event
Event output EVT3 allocation (A3 option)	No event
Event output EVT4 allocation (A5 option)	No event
Event output EVT5 allocation (A5 option)	No event

• **Program group (p. 43)**

Setting item	Default value
Fixed value control/Program control	Fixed value control
Step time unit	Hour:Minute
Power restore action	Stops after power restoration
Program start temperature	0°C

• **Communication group (C or C5 option) (p. 44)**

Setting item	Default value
Communication protocol	Shinko protocol
Instrument number	0
Communication speed	9600bps
Data bit/Parity	7 bits /Even
Stop bit	1
SVTC bias	0°C

• **External setting group (EA□ or EV□ option) (p. 45)**

Setting item	Default value
Remote/Local	Local
External setting input high limit	1370°C
External setting input low limit	-200°C
Remote bias	0°C

• **Transmission output group (TA1 or TV1 option) (p. 46)**

Setting item	Default value
Transmission output	PV transmission
Transmission output high limit	1370°C
Transmission output low limit	-200°C

• **Other function group (pages 47-51)**

Setting item	Default value
Set value lock	Unlock
PID zone function	Not used
SV rise rate	0°C/min
SV fall rate	0°C/min
Indication when output OFF	OFF indication
Backlight	All are backlit
PV color	Red
PV color range	5.0°C
Backlight time	0min
Bar graph indication	MV indication
Deviation unit	1°C

7.1 Turn the power supply to the unit ON.

After the power is turned on, the PV display indicates the input type, and the SV display indicates the input range high limit value (thermocouple, RTD input) or scaling high limit value (DC voltage, current input) for approximately 3 seconds. (Table 7.1-1)

During this time, all outputs and the indicators are in OFF status.

Control will then start indicating the PV (process variable) on the PV display and SV (desired value) on the SV display.

While control output OFF function is working, the PV display indicates ΔFF .

(Indication depends on the selection during "Indication when output OFF".)

(Table 7.1-1)

Sensor input	°C		°F	
	PV display	SV display	PV display	SV display
K	K	1370	K	2498
	K	4000	K	7520
J	J	1000	J	1800
R	R	1760	R	3200
S	S	1760	S	3200
B	B	1820	B	3300
E	E	1800	E	1500
T	T	4000	T	7500
N	N	1300	N	2300
PL-II	PL2	1390	PL2	2500
C(W/Re5-26)	c	23 15	c	4200
Pt100	Pt	8500	Pt	15620
JPt100	JPt	5000	JPt	9320
Pt100	Pt	850	Pt	1562
JPt100	JPt	500	JPt	932
Pt100	Pt 1	1000	Pt 2	2 120
Pt100	Pt 5	5000	Pt 9	9320
4 to 20mA DC	420mA	Scaling high limit value		
0 to 20mA DC	020mA			
0 to 10mV DC	0 10mV			
-10 to 10mV DC	- 10mV			
0 to 50mV DC	0 50mV			
0 to 100mV DC	100mV			
0 to 1V DC	0 10V			
0 to 5V DC	0 50V			
1 to 5V DC	1 50V			
0 to 10V DC	0 100V			

7.2 Basic operation of settings



To proceed to each setting mode, refer to each setting mode.

- To set each setting item, use the Δ or ∇ key.
- If the MODE key is pressed, the set value is registered, and the unit proceeds to the next setting item.
- If the MODE key is pressed at the last setting item, the unit proceeds to the first setting item.
- Pressing the $\frac{A/M}{B/MODE}$ key reverts to the previous setting item.
- Pressing the $\frac{A/M}{B/MODE}$ key for 1sec reverts to the previous setting level (reverts from setting item to each group).
- If the MODE key is pressed for 3sec at the setting group or item, the unit reverts to the PV/SV display mode.

7.3 Engineering group

7.3.1 Input group





To enter the Input group, follow the procedures below.

- (1)  Press the **SET** key 4 times in the PV/SV display mode.
The unit will enter the Engineering group.
- (2)  Press the **MODE** key once. The unit will proceed to the Input group.
- (3)  Press the **MODE** key once.
The unit will proceed to the Input type selection.

Character	Name, Function, Setting range	Default value																																																									
	Input type <ul style="list-style-type: none"> • The input type can be selected from thermocouple (10 types), RTD (2 types), DC current (2 types) and DC voltage (8 types), and the unit °C/°F can be selected as well. • If the input type is changed, scaling high and low limit also change to the high and low limit value of the altered input range. • When changing the input from DC voltage to other inputs, remove the sensor connected to this controller first, then change the input. If the input is changed with the sensor connected, the input circuit may break. • With DC voltage input, the (+) side input terminal number differs as follows. <p>(+) side input terminal number of 0-5V DC, 1-5V DC, 0-10V DC: 16 (+) side input terminal number of 0-10 mV DC, -10-10mV DC, 0-50mV DC, 0-100mV DC, 0-1V DC: 18</p> <ul style="list-style-type: none"> • Input types <table border="1"> <tbody> <tr><td>K000C</td><td>K</td><td>-200 to 1370 °C</td></tr> <tr><td>K00.C</td><td>K</td><td>-200.0 to 400.0 °C</td></tr> <tr><td>J000C</td><td>J</td><td>-200 to 1000 °C</td></tr> <tr><td>R000C</td><td>R</td><td>0 to 1760 °C</td></tr> <tr><td>S000C</td><td>S</td><td>0 to 1760 °C</td></tr> <tr><td>B000C</td><td>B</td><td>0 to 1820 °C</td></tr> <tr><td>E000C</td><td>E</td><td>-200 to 800 °C</td></tr> <tr><td>T00.C</td><td>T</td><td>-200.0 to 400.0 °C</td></tr> <tr><td>N000C</td><td>N</td><td>-200 to 1300 °C</td></tr> <tr><td>PL20C</td><td>PL-II</td><td>0 to 1390 °C</td></tr> <tr><td>C000C</td><td>C(W/Re5-26)</td><td>0 to 2315 °C</td></tr> <tr><td>Pt0.C</td><td>Pt100</td><td>-200.0 to 850.0 °C</td></tr> <tr><td>JPt.C</td><td>JPt100</td><td>-200.0 to 500.0 °C</td></tr> <tr><td>Pt00C</td><td>Pt100</td><td>-200 to 850 °C</td></tr> <tr><td>JPt0C</td><td>JPt100</td><td>-200 to 500 °C</td></tr> <tr><td>Pt1.C</td><td>Pt100</td><td>-100.0 to 100.0 °C</td></tr> <tr><td>Pt5.C</td><td>Pt100</td><td>-100.0 to 500.0 °C</td></tr> <tr><td>K000F</td><td>K</td><td>-328 to 2498 °F</td></tr> <tr><td>K00.F</td><td>K</td><td>-328.0 to 752.0 °F</td></tr> </tbody> </table>	K000C	K	-200 to 1370 °C	K00.C	K	-200.0 to 400.0 °C	J000C	J	-200 to 1000 °C	R000C	R	0 to 1760 °C	S000C	S	0 to 1760 °C	B000C	B	0 to 1820 °C	E000C	E	-200 to 800 °C	T00.C	T	-200.0 to 400.0 °C	N000C	N	-200 to 1300 °C	PL20C	PL-II	0 to 1390 °C	C000C	C(W/Re5-26)	0 to 2315 °C	Pt0.C	Pt100	-200.0 to 850.0 °C	JPt.C	JPt100	-200.0 to 500.0 °C	Pt00C	Pt100	-200 to 850 °C	JPt0C	JPt100	-200 to 500 °C	Pt1.C	Pt100	-100.0 to 100.0 °C	Pt5.C	Pt100	-100.0 to 500.0 °C	K000F	K	-328 to 2498 °F	K00.F	K	-328.0 to 752.0 °F	K (-200 to 1370°C)
K000C	K	-200 to 1370 °C																																																									
K00.C	K	-200.0 to 400.0 °C																																																									
J000C	J	-200 to 1000 °C																																																									
R000C	R	0 to 1760 °C																																																									
S000C	S	0 to 1760 °C																																																									
B000C	B	0 to 1820 °C																																																									
E000C	E	-200 to 800 °C																																																									
T00.C	T	-200.0 to 400.0 °C																																																									
N000C	N	-200 to 1300 °C																																																									
PL20C	PL-II	0 to 1390 °C																																																									
C000C	C(W/Re5-26)	0 to 2315 °C																																																									
Pt0.C	Pt100	-200.0 to 850.0 °C																																																									
JPt.C	JPt100	-200.0 to 500.0 °C																																																									
Pt00C	Pt100	-200 to 850 °C																																																									
JPt0C	JPt100	-200 to 500 °C																																																									
Pt1.C	Pt100	-100.0 to 100.0 °C																																																									
Pt5.C	Pt100	-100.0 to 500.0 °C																																																									
K000F	K	-328 to 2498 °F																																																									
K00.F	K	-328.0 to 752.0 °F																																																									



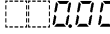
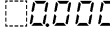
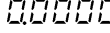

Character	Name, Function, Setting range	Default value
J000F	J	-328 to 1832 °F
R000F	R	32 to 3200 °F
4000F	S	32 to 3200 °F
b000F	B	32 to 3308 °F
E000F	E	-328 to 1472 °F
T00.F	T	-328.0 to 752.0 °F
N000F	N	-328 to 2372 °F
PL20F	PL-II	32 to 2534 °F
c000F	C(W/Re5-26)	32 to 4199 °F
Pt0.F	Pt100	-328.0 to 1562.0 °F
JPt0.F	JPt100	-328.0 to 932.0 °F
Pt00F	Pt100	-328 to 1562 °F
JPt0F	JPt100	-328 to 932 °F
Pt2.F	Pt100	-148.0 to 212.0 °F
Pt9.F	Pt100	-148.0 to 932.0 °F
420mA	4 to 20mA DC	-2000 to 10000
020mA	0 to 20mA DC	-2000 to 10000
010mV	0 to 10mV DC	-2000 to 10000
-10mV	-10 to 10mV DC	-2000 to 10000
050mV	0 to 50mV DC	-2000 to 10000
100mV	0 to 100mV DC	-2000 to 10000
001V	0 to 1V DC	-2000 to 10000
005V	0 to 5V DC	-2000 to 10000
105V	1 to 5V DC	-2000 to 10000
010V	0 to 10V DC	-2000 to 10000
4FLH 1370	Scaling high limit (*) • Sets scaling high limit value. • Setting range: Scaling low limit value to input range high limit value DC voltage, current input: -2000 to 10000 (The placement of the decimal point follows the selection.)	1370°C
4FL -200	Scaling low limit (*) • Sets scaling low limit value. • Setting range: Input range low limit value to scaling high limit value DC voltage, current input: -2000 to 10000 (The placement of the decimal point follows the selection.)	-200°C



(*) In the case of DC voltage, current input, if Scaling high limit value < Scaling low limit value is set, PV scaling decrease/input increase is possible.





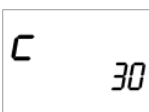
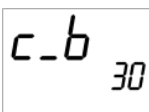

Character	Name, Function, Setting range	Default value
	<p>Decimal point place</p> <ul style="list-style-type: none"> • Selects decimal point place. Available only for DC voltage and current input •  : No decimal point •  : 1 digit after decimal point •  : 2 digits after decimal point •  : 3 digits after decimal point •  : 4 digits after decimal point 	<p>No decimal point</p>
	<p>PV filter time constant</p> <ul style="list-style-type: none"> • Sets PV filter time constant. If the value is set too large, it affects control result due to the delay of response. • Setting range: 0.0 to 100.0 seconds 	<p>0.0sec</p>
	<p>Sensor correction</p> <ul style="list-style-type: none"> • Sets the correction value for the sensor. This corrects the input value from the sensor. When a sensor cannot be set at the exact location where control is desired, the sensor measured temperature may deviate from the temperature in the controlled location. When controlling with plural controllers, sometimes the measured temperatures do not concur due to differences in sensor accuracy or dispersion of load capacities. In such a case, the control can be set at the desired temperature by adjusting the input value of sensors. PV after sensor correction= Current PV+ Sensor correction value • Setting range: -200.0 to 200.0°C (°F) DC voltage, current input: -2000 to 2000 (The placement of the decimal point follows the selection.) 	<p>0.0°C</p>

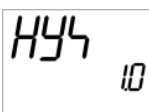
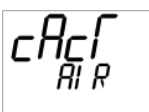
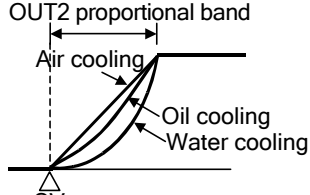
7.3.2 Output group

To enter the Output group, follow the procedures below.

- (1)  Press the **SET** key 4 times in the PV/SV display mode.
The unit will enter the Engineering group.
- (2)  Press the **MODE** key once. The unit will proceed to the Input group.
- (3)  Press the **SET** key once. The unit will proceed to the Output group.
- (4)  Press the **MODE** key once.
The unit will proceed to the OUT1 proportional cycle setting.





Character	Name, Function, Setting range	Default value
	OUT1 proportional cycle <ul style="list-style-type: none"> Sets proportional cycle for OUT1. For relay contact output, if the proportional cycle time is decreased, the frequency of the relay action increases, and the life of the relay contact is shortened. Not available if OUT1 is in ON/OFF action or DC current output type. Setting range: 1 to 120 seconds 	Relay contact: 30sec Non-contact voltage: 3sec
	OUT2 proportional cycle <ul style="list-style-type: none"> Sets proportional cycle for OUT2 For relay contact output, if the proportional cycle time is decreased, the frequency of the relay action increases, and the life of the relay contact is shortened. Not available if the D option is not added or if OUT2 is in ON/OFF action. Setting range: 1 to 120 seconds 	Relay contact: 30sec Non-contact voltage: 3sec
	OUT1 high limit <ul style="list-style-type: none"> Sets the high limit value of OUT1. Not available if OUT1 is in ON/OFF action Setting range: OUT1 low limit value to 100% (DC current output type: OUT1 low limit value to 105%) 	100%
	OUT1 low limit <ul style="list-style-type: none"> Sets the low limit value of OUT1. Not available if OUT1 is in ON/OFF action. Setting range: 0% to OUT1 high limit value (DC current output type: -5% to OUT1 high limit value) 	0%
	OUT1 ON/OFF action hysteresis <ul style="list-style-type: none"> Sets ON/OFF action hysteresis for OUT1. Available only when OUT1 is in ON/OFF action Setting range: 0.1 to 1000.0°C (°F), DC voltage, current input: 1 to 10000 (The placement of the decimal point follows the selection.) 	1.0°C
	OUT2 action mode <ul style="list-style-type: none"> Selects OUT2 action from air, oil and water cooling. Not available if the D option is not added or if OUT2 is in ON/OFF action Air R: Air cooling (linear characteristic) Oil L: Oil cooling (1.5th power of the linear characteristic) Water: Water cooling (2nd power of the linear characteristic) 	Air cooling 





Character	Name, Function, Setting range	Default value
	OUT2 high limit <ul style="list-style-type: none"> Sets OUT2 high limit value. Not available if the D□ option is not added or if OUT2 is in ON/OFF action Setting range: OUT2 low limit value to 100% (DC current output type: OUT2 low limit value to 105%) 	100%
	OUT2 low limit <ul style="list-style-type: none"> Sets OUT2 low limit value. Not available if the D□ option is not added or if OUT2 is in ON/OFF action Setting range: 0% to OUT2 high limit value (DC current output type: -5% to OUT2 high limit value) 	0%
	Overlap band/Dead band <ul style="list-style-type: none"> Sets the overlap band or dead band for OUT1 and OUT2. + Set value: Dead band, -Set value: Overlap band Available only when the D□ option is added Setting range: -200.0 to 200.0°C (°F), DC voltage, current input: -2000 to 2000 (The placement of the decimal point follows the selection.) 	0.0°C
	OUT2 ON/OFF action hysteresis <ul style="list-style-type: none"> Sets ON/OFF action hysteresis for OUT2. Available when the D□ option is added, and when OUT2 is in ON/OFF control action. Setting range: 0.1 to 1000.0°C (°F), DC voltage, current input: 1 to 10000 (The placement of the decimal point follows the selection.) 	1.0°C
	Direct/Reverse control action <ul style="list-style-type: none"> Selects either Reverse (Heating) or Direct (Cooling) control action. HEAT□ : Reverse (Heating) action cool□ : Direct (Cooling) action 	Reverse (Heating) action
	OUT1 preset output <ul style="list-style-type: none"> If the Preset output function is selected during the Event input allocation, OUT1 MV in case of sensor burnout can be set. Available only when EI option is added Setting range: 0.0 to 100.0% (DC current output: -5.0 to 105.0%) 	0.0%
	OUT2 preset output <ul style="list-style-type: none"> If the Preset output function is selected during the Event input allocation, OUT2 MV in case of sensor burnout can be set. Available when D□ and EI option is added Setting range: 0.0 to 100.0% (DC current output: -5.0 to 105.0%) 	0.0%

7.3.3 Event input group

This group is available only when EI option is added.

To enter the Event input group, follow the procedures below.

- (1)  Press the **SET** key 4 times in the PV/SV display mode.
The unit will enter the Engineering group.
- (2)  Press the **MODE** key once. The unit will proceed to the Input group.
- (3)  Press the **SET** key twice. The unit will proceed to the Event input group.
- (4)  Press the **MODE** key once.
The unit will proceed to the Event input EVI1 allocation.

Character	Name, Function, Setting range	Default value
	Event input EVI1 allocation • Selects Event input EVI1 from Event input allocation table. • Refer to the Event input allocation table.	000 (No event)
	Event input EVI2 allocation • Selects Event input EVI2 from Event input allocation table. • Refer to the Event input allocation table.	000 (No event)
	Event input EVI3 allocation • Selects Event input EVI3 from Event input allocation table. • Refer to the Event input allocation table.	000 (No event)
	Event input EVI4 allocation • Selects Event input EVI4 from Event input allocation table. • Refer to the Event input allocation table.	000 (No event)

Event input allocation table

Selected value	Event input function	Input ON (Closed)	Input OFF (Open)	Remarks
000	No event			
001	Set value memory	2 ⁿ	1	n=0 to 3 (*1)
002	Control ON/OFF	Control ON	Control OFF	OUT/OFF function
003	Direct/Reverse action	Direct action	Reverse action	Always effective
004	Timer Start/Stop	Start	Stop	
005	PV display; PV holding	Holding	Not holding	Ineffective when controlling
006	PV display; PV peak value holding	Holding	Not holding	Ineffective when controlling

Selected value	Event input function	Input ON (Closed)	Input OFF (Open)	Remarks
007	Preset output	Preset output (*2)	Standard control	In case of sensor burnout, the unit maintains control with the preset output MV.
008	Auto/Manual control	Manual control	Automatic control	
009	Remote/Local	Remote	Local	Effective only when EA□ or EV□ option is added
010	Program mode; RUN/STOP	RUN	STOP	Level action when power-on
011	Program mode; Holding/Not holding	Holding	Not holding	Level action when power-on
012	Program mode; Advance function	Advance	Standard control	Level action when power-on
013	Integral action holding	Integral action Holding	Standard integral action	Control continues with the integral value being held.

Signal edge from OFF to ON or from ON to OFF is valid.

If "010 (Program mode RUN/STOP)" is selected during Event input EVI1 allocation, the following action will be performed. However, for action when power is turned ON, Level action [ON (Closed) or OFF (Open)] is adopted.

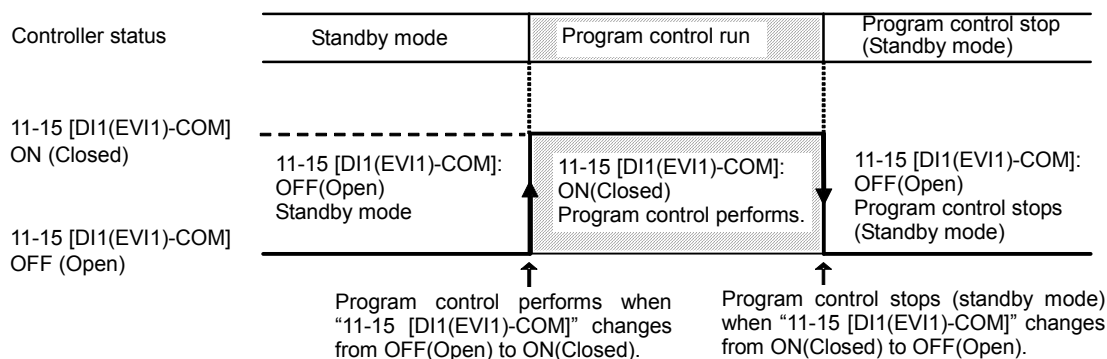

(Fig. 7.3.3-1)

OR computation [if any one is ON (closed), the function activates] begins if the same functions except "001(Set value memory)" have been selected for plural Event inputs.

(*1) The value that 1 (one) is added to 2^n , is indicated on the MEMO/STEP display.





(e.g.) If $EVI1(2^0)=OFF$, $EVI2(2^1)=ON$, then $3(2^1 + 1)$ is indicated.





2^0 , 2^1 , 2^2 and 2^3 will be allocated to Event input EVI1 to EVI4 respectively, and the Set value memory number will be determined by each value of EVI1 to EVI4. (Refer to Section "9.7 Set value memory function" on p.76.)

(*2) Preset value can be set during OUT1, OUT2 preset output setting (p.32) in the Output group.

7.3.4 Event output group

To enter the Event output group, follow the procedures below.

- (1)  Set the **SET** key 4 times in the PV/SV display mode.
The unit will enter the Engineering group.
- (2)  Press the **MODE** key once. The unit will proceed to the Input group.
- (3)  Press the **SET** key several times until characters of the Event output group appears.
- (4)  Press the **MODE** key once.
The unit will proceed to the Event output EVT1 allocation.

Character	Name, Function, Setting range	Default value
	Event output EVT1 allocation • Selects Event output EVT1 from the Event output allocation table. • Refer to the Event output allocation table.	000 (No event)
	Event output EVT2 allocation • Selects Event output EVT2 from the Event output allocation table. • Refer to the Event output allocation table.	000 (No event)
	Event output EVT3 allocation • Selects Event output EVT3 from the Event output allocation table. Available only when A3 option is added • Refer to the Event output allocation table.	000 (No event)
	Event output EVT4 allocation • Selects Event output EVT4 from the Event output allocation table. Available only when A5 option is added • Refer to the Event output allocation table.	000 (No event)
	Event output EVT5 allocation • Selects Event output EVT5 from the Event output allocation table. Available only when A5 option is added • Refer to the Event output allocation table.	000 (No event)

Event output allocation table

Selected value	Event output function	Proceeding to the lower level with the MODE key	Remarks
000	No event		
001	Alarm output; High limit alarm	Alarm hysteresis ↓ MODE Alarm action delayed timer ↓ MODE Alarm Energized/De-energized	
002	Alarm output; Low limit alarm	The same as the High limit alarm	
003	Alarm output; High/Low limits	The same as the High limit alarm	
004	Alarm output; High/Low limits independent	The same as the High limit alarm	

Selected value	Event output function	Proceeding to the lower level with the MODE key	Remarks
005	Alarm output; High/Low limit range	The same as the High limit alarm	
006	Alarm output; High/Low limit range independent	The same as the High limit alarm	
007	Alarm output; Process high alarm	The same as the High limit alarm	
008	Alarm output; Process low alarm	The same as the High limit alarm	
009	Alarm output; High limit with standby	The same as the High limit alarm	
010	Alarm output; Low limit with standby	The same as the High limit alarm	
011	Alarm output; High/Low limits with standby	The same as the High limit alarm	
012	Alarm output; High/Low limits with standby independent	The same as the High limit alarm	
013	Timer output interlocked with "Timer Start/Stop" in Event input allocation.	Timer output delay action ↓ MODE Timer output time unit ↓ MODE OFF delay timer time ↓ MODE ON delay timer time	Select "Timer Start/Stop" in Event input allocation. (p.33)
014	Timer output interlocked with "Timer Start/Stop" in Event input allocation. Control ON during timer operation. Control OFF after time is up.	The same as the above	The same as the above
015	Heater burnout alarm output	Heater rated current ↓ MODE Heater burnout alarm 1 value ↓ MODE Heater burnout alarm 2 value	Rated current 20A or 100A. Settable within the rated current (*)
016	Loop break alarm output	Loop break alarm time ↓ MODE Loop break alarm span	
017	Time signal output	Time signal output step ↓ MODE Time signal OFF time ↓ MODE Time signal ON time	Time signal output is turned off when the performing step is complete.
018	Output during AT		Outputs during AT
019	Pattern end output		Program control

- If an alarm type is changed, the alarm set value becomes 0 (0.0).
 - If "001 to 012 (Alarm output)" is selected : Individual setting for event outputs
 - If "013 to 019" is selected : Common setting to the plural event outputs
- (*) Available only when W or W3 option is added.

Pattern end output



After the program control is completed, pattern end output is turned ON.
 The following program pattern shows that the temperature rises to 200°C for 1 hour, and stays at 200°C for 2 hours after program control starts.

Step	1	2
Step SV	200°C	1:00
Step time	200°C	2:00

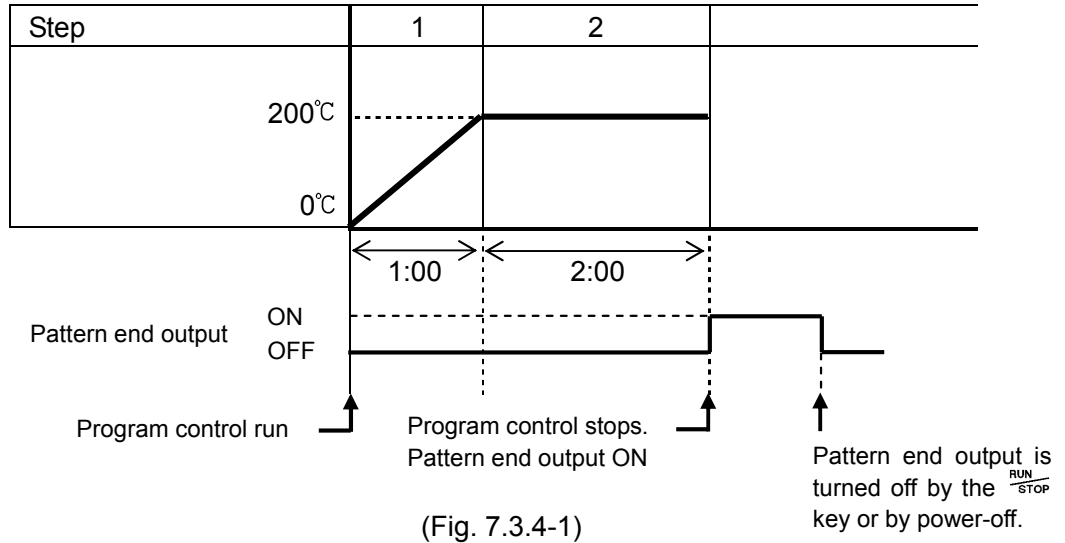
Pattern end output is shown below in (Fig. 7.3.4-1).



• Alarm output setting items [When alarm output (001 to 012) is selected]

Character	Name, Function, Setting range	Default value
 (*)	Alarm hysteresis <ul style="list-style-type: none"> • Sets Alarm hysteresis. • Setting range: 0.1 to 1000.0°C(°F) DC voltage, current input: 1 to 10000 (The placement of the decimal point follows the selection.) 	1.0°C
 (*)	Alarm action delayed timer <ul style="list-style-type: none"> • Sets Alarm action delayed timer. When setting time has elapsed after the input enters the alarm output range, the alarm is activated. • Setting range: 0 to 10000sec 	0sec
 (*)	Alarm Energized/De-energized <ul style="list-style-type: none"> • Selects Energized/De-energized status for Alarm. (Refer to “Alarm action Energized/De-energized”) • <i>NoML</i>□ : Energized • <i>REV</i>□ : De-energized 	Energized

(*): If “001 (Alarm output; High limit alarm) to 012 (Alarm output; High/Low limits with standby independent)” is selected during Event output EVT2 to EVT5 allocation, their setting characters will be *R2xxx* to *R5xxx*.

[Alarm action Energized/De-energized]

When [Alarm Energized (*NoML*□)] is selected, EVT1 output (between terminals 9-10) is conductive (ON) while the EVT1 indicator is lit.
EVT1 output is not conductive (OFF) while EVT1 indicator is not lit.

When [Alarm De-energized (*REV*□)] is selected, EVT1 output (between terminals 9-10) is not conductive (OFF) while EVT1 indicator is lit.
EVT1 output is conductive (ON) while EVT1 indicator is not lit.

High limit alarm (when Energized is set) High limit alarm (when De-energized is set)

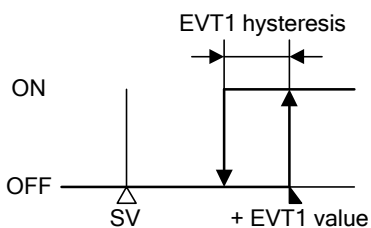

(Fig. 7.3.4-2)

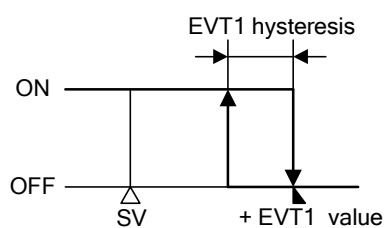

(Fig. 7.3.4-3)



For EVT2 to EVT5, the alarm action is the same as that of EVT1.

For EVT2 to EVT5, read “EVT2 to EVT5” for “EVT1”.

- EVT2 output (between terminals 7-8) (A3 option: between terminals 8-10)
- EVT3 output (between terminals 7-10)
- EVT4 output (between terminals 29-30)
- EVT5 output (between terminals 28-30)



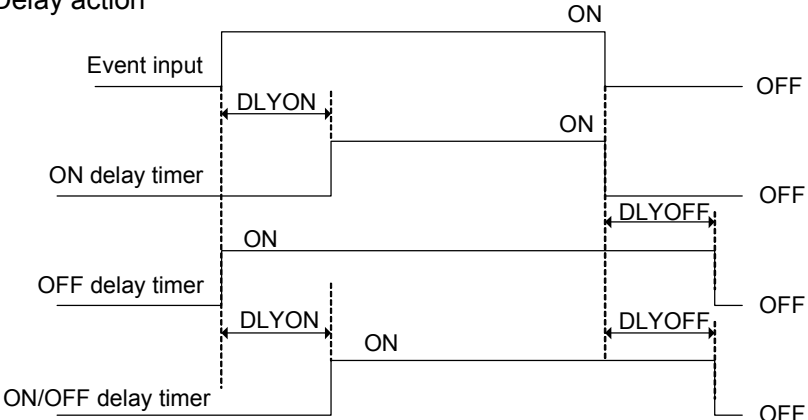
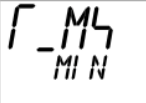

• **Timer output setting items [When Timer output (013, 014) is selected]**

Available only when the EI option is added.

Character	Name, Function, Setting range	Default value
	<p>Timer output delay action</p> <ul style="list-style-type: none"> • Selects a Timer output action. • <code>ON</code>: ON delay timer • <code>OFF</code>: OFF delay timer • <code>ONOFF</code>: ON/OFF delay timer • Delay action  <p>DLYON : ON delay timer time setting DLYOFF: OFF delay timer time setting (Fig. 7.3.4-4)</p>	<p>ON delay timer</p>
	<p>Timer output time unit</p> <ul style="list-style-type: none"> • Selects Timer output time unit. • <code>MIN</code>: Minute • <code>SEC</code>: Second 	<p>Minute</p>
	<p>OFF delay timer time</p> <ul style="list-style-type: none"> • Sets OFF delay timer time. • Setting range: 0 to 10000 (Time unit follows the selection from the Timer output time unit selection.) 	<p>0</p>
	<p>ON delay timer time</p> <ul style="list-style-type: none"> • Sets ON delay timer time. • Setting range: 0 to 10000 (Time unit follows the selection from the Timer output time unit selection.) 	<p>0</p>

• **Heater burnout alarm output setting items [When Heater burnout alarm output (015) is selected]**

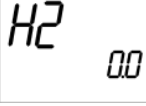

Available only when W, W3 option is added.

Character	Name, Function, Setting range	Default value
	Heater rated current <ul style="list-style-type: none"> • Selects heater rated current. • If heater rated current is changed, Heater burnout alarm 1 and 2 value will return to 0.0. • : 20.0A : 100.0A 	20.0A
 <p><i>H</i> and CT1 current alternating display (on the PV display)</p>	Heater burnout alarm 1 value <ul style="list-style-type: none"> • Sets the heater current value for Heater burnout alarm 1. Setting to 0.0 disables the alarm. CT1 current value and character <i>H</i> are indicated alternately on the PV display. When OUT1 is ON, the CT1 current value is updated. When OUT1 is OFF, the unit memorizes the previous value when OUT1 was ON. Upon returning to set limits, the alarm will stop. • Rated current: 20.0A (0.0 to 20.0A), 100.0A (0.0 to 100.0A) 	0.0A
 <p><i>H2</i> and CT2 current alternating display (on the PV display)</p>	Heater burnout alarm 2 value <ul style="list-style-type: none"> • Sets the heater current value for Heater burnout alarm 2. Setting to 0.0 disables the alarm. CT2 current value and characters <i>H2</i> are indicated alternately on the PV display. When OUT1 is ON, the CT2 current value is updated. When OUT1 is OFF, the unit memorizes the previous value when OUT1 was ON. Upon returning to set limits, the alarm will stop. Available only when W3 option is added • Rated current: 20.0A (0.0 to 20.0A), 100.0A (0.0 to 100.0A) 	0.0A

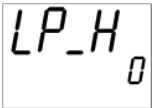
• **Loop break alarm output setting items [When Loop break alarm output (016) is selected]**

Character	Name, Function, Setting range	Default value
	Loop break alarm time <ul style="list-style-type: none"> • Sets the time to assess the Loop break alarm. • Setting to 0 (zero) disables the alarm. • Setting range: 0 to 200 minutes 	0 minutes
	Loop break alarm span <ul style="list-style-type: none"> • Sets the temperature to assess the Loop break alarm. • Setting to 0 (zero) disables the alarm. • Setting range: 0 to 150°C (°F), 0.0 to 150.0°C (°F) DC voltage and current input: 0 to 1500 (The placement of the decimal point follows the selection)	0°C

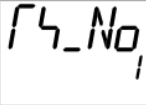
• **Time signal output setting items [When Time signal output (017) is selected]**

Character	Name, Function, Setting range	Default value
	Time signal output step • Sets step number for time signal output performance. • Setting range: 1 to 15	1
	Time signal output OFF time • Sets the Time signal output OFF time. • Setting range: 00:00 to 99:59 (Time unit follows the selection from the Step time unit selection in the Program group.)	00:00
	Time signal output ON time • Sets the Time signal output ON time. • Setting range: 00:00 to 99:59 (Time unit follows the selection from the Step time unit selection in the the Program group)	00:00

Time signal output

Time signal output activates during Time signal output ON time within the set step for which Time signal output is performed.

Time signal output ON time follows Time signal output OFF time after the program control starts.

The following program pattern shows that the temperature rises to 200°C for 1 hour, and stays at 200°C for 2 hours after program control starts.

Step	1	2
Step SV	200°C	1:00
Step time	200°C	2:00

Time signal output (Fig. 7.3.4-5) is shown when set as follows.

- The step for which Time signal output is performed: 2
- Time signal output OFF time setting : 0:30
- Time signal output ON time setting : 1:00

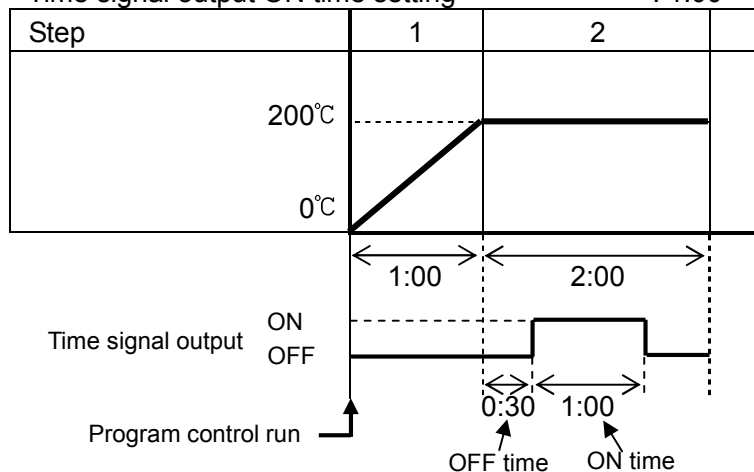













(Fig. 7.3.4-5)

Time signal output is effective within the step set during “Time signal output step” setting. For example, if Time signal output ON time is set to “2:00” at the above, Time signal output is turned OFF when step 2 is completed.

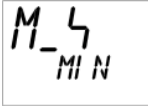
7.3.5 Program group

To enter the Program group, follow the procedures below.



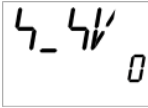

- (1)  Set the **SET** key 4 times in the PV/SV display mode.
The unit will enter the Engineering group.
- (2)  Press the **MODE** key once. The unit will proceed to the Input group.
- (3)  Press the **SET** key several times until characters of the Program group appears.
- (4)  Press the **MODE** key once.
The unit will proceed to the Fixed value control/Program control selection.





Character	Name, Function, Setting range	Default value
	Fixed value control/Program control <ul style="list-style-type: none"> • Selects Fixed value control or Program control. • $FI\ x$ : Fixed value control • PRo : Program control 	Fixed value control
	Step time unit <ul style="list-style-type: none"> • Selects the Step time unit for the program control. • Available only for the program control. • $MI\ N$ : Hour:Minute • $4E$ : Minute:Second 	Hour/Minute
	Power restore action <ul style="list-style-type: none"> • Selects the program status if a power failure occurs mid-program and it is restored. • Available only for the program control • $4T$ : Stops (Standby) after power restoration • oN : Continues after power restoration • $HoLd$ : Suspended (On hold) after power restoration 	Stops (standby) after power restoration
	Program start temperature <ul style="list-style-type: none"> • Sets the step temperature when program starts. • Available only for the program control • Setting range: Scaling low limit value to Scaling high limit value 	0°C

7.3.6 Communication group

Available when C, C5 option is added.

To enter the Communication group, follow the procedures below.



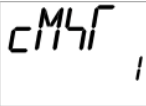
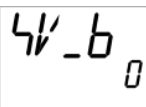

- (1)  Set the **SET** key 4 times in the PV/SV display mode.
The unit will enter the Engineering group.
- (2)  Press the **MODE** key once. The unit will proceed to the Input group.
- (3)  Press the **SET** key several times until characters of the Communication group appear.
- (4)  Press the **MODE** key once.
The unit will proceed to the Communication protocol selection.



Character	Name, Function, Setting range	Default value
	Communication protocol • Selects communication protocol. • <i>NoML</i> <input type="checkbox"/> : Shinko protocol <i>ModA</i> <input type="checkbox"/> : Modbus ASCII mode <i>ModR</i> <input type="checkbox"/> : Modbus RTU mode	Shinko protocol
	Instrument number • Sets the instrument number individually to each instrument when communicating by connecting plural instruments in serial communication. • Setting range: 0 to 95	0
	Communication speed • Selects a communication speed equal to that of the host computer. • <input type="checkbox"/> <i>96</i> : 9600bps <input type="checkbox"/> <i>192</i> : 19200bps <input type="checkbox"/> <i>384</i> : 38400bps	9600bps
	Data bit/Parity • Selects data bit and parity. • <i>8NoM</i> <input type="checkbox"/> : 8 bits/No parity <i>7NoM</i> <input type="checkbox"/> : 7 bits/No parity <i>8EVN</i> <input type="checkbox"/> : 8 bits/Even parity <i>7EVN</i> <input type="checkbox"/> : 7 bits/Even parity <i>8odd</i> <input type="checkbox"/> : 8 bits/Odd parity <i>7odd</i> <input type="checkbox"/> : 7 bits/Odd parity	7 bits/Even parity
	Stop bit • Selects the stop bit. • <input type="checkbox"/> <i>1</i> : 1 <input type="checkbox"/> <i>2</i> : 2	1
	SVTC bias • Control desired value (SV) adds SVTC bias value to the value received by the SVTC command. • Available only when Shinko protocol is selected during communication protocol selection. • Setting range: Converted value of $\pm 20\%$ of the input span DC voltage, current input: $\pm 20\%$ of the scaling span (The placement of the decimal point follows the selection.)	0°C

7.3.7 External setting group

Available only when the EA□ or EV□ option is added.

To enter the External setting group, follow the procedures below.



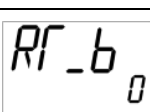

- (1)  Set the **SET** key 4 times in the PV/SV display mode.
The unit will enter the Engineering group.
- (2)  Press the **MODE** key once. The unit will proceed to the Input group.
- (3)  Press the **SET** key several times until characters of the External setting group appears.
- (4)  Press the **MODE** key once.
The unit will proceed to the Remote/Local selection.







Character	Name, Function, Setting range	Default value
	Remote/Local • Selects Remote or Local setting of the SV (desired value). • <i>LocAL</i> : Local (The SV can be set by front keypad.) • <i>REMoF</i> : Remote (The SV can be set in analog by the remote operation externally.)	Local
	External setting input high limit • Sets External setting input high limit value. [For EA1 (4-20mA) option, the value corresponds to 20mA input.] • Setting range: External setting input low limit to Input range high limit (The placement of the decimal point follows the selection.)	1370°C
	External setting input low limit • Sets External setting input low limit value. [For EA1 (4-20mA) option, the value corresponds to 4mA input.] • Setting range: Input range low limit to External setting input high limit (The placement of the decimal point follows the selection.)	-200°C
	Remote bias • During remote action, SV (desired value) adds the remote bias value. • Setting range: Converted value of ±20% of the input span DC voltage, current input: ±20% of the scaling span (The placement of the decimal point follows the selection.)	0°C

7.3.8 Transmission output group

Available only when TA1 or TV1 option is added.





To enter the Transmission output group, follow the procedures below.





- (1)  Set the **SET** key 4 times in the PV/SV display mode.
The unit will enter the Engineering group.
- (2)  Press the **MODE** key once. The unit will proceed to the Input group.
- (3)  Press the **SET** key several times until characters of the Transmission output group appears.
- (4)  Press the **MODE** key once.
The unit will proceed to the Transmission output selection.



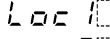
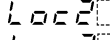
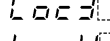
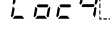

Character	Name, Function, Setting range	Default value
	Transmission output <ul style="list-style-type: none"> • Selects transmission output type. • PV : PV (process variable) transmission • SV : SV (desired value) transmission • MV : MV (manipulated variable) transmission • DV : DV (deviation) transmission 	PV transmission
	Transmission output high limit <ul style="list-style-type: none"> • Sets the Transmission output high limit value. [For TA1 (4-20mA) option, the value corresponds to 20mA output.] • Setting range: PV, SV transmission: Transmission output low limit to Input range high limit value MV transmission: Transmission output low limit value to 105.0 (%) DV transmission: Transmission output low limit to Scaling span 	1370°C
	Transmission output low limit <ul style="list-style-type: none"> • Sets the Transmission output low limit value. [For TA1 (4-20mA) option, the value corresponds to 4mA output.] • Setting range: PV, SV transmission: Input range low limit to Transmission output high limit value MV transmission: -5.0 to Transmission output high limit value (%) DV transmission: -Scaling span to Transmission output high limit value 	-200°C

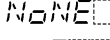
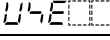





7.3.9 Other function group

To enter Other function group, follow the procedures below.

- (1)  Set the **SET** key 4 times in the PV/SV display mode.
The unit will enter the Engineering group.
- (2)  Press the **MODE** key once. The unit will proceed to the Input group.
- (3)  Press the **SET** key several times or $\frac{A/M}{BMODE}$ key once until characters of Other function group appears.
- (4)  Press the **MODE** key once.
The unit will proceed to the Set value lock selection.

Character	Name, Function, Setting range	Default value
	Set value lock <ul style="list-style-type: none"> • Locks the set values to prevent setting errors. The setting item to be locked depends on the selection. • With any selection from Lock 1 to Lock 4, Auto-tuning or Auto-reset cannot be carried out. • - - - - - (Unlock): All set values can be changed. • <i>Loc 1</i>  (Lock 1): None of the set values can be changed. • <i>Loc 2</i>  (Lock 2): Only SV (desired value) can be changed. • <i>Loc 3</i>  (Lock 3): None of the set values can be changed as Lock 1. • <i>Loc 4</i>  (Lock 4): SV and Alarm value can be changed. Other set values cannot be changed. 	Unlock
	PID zone function <ul style="list-style-type: none"> • Selects “Not used/Used” of the PID zone function. Control is performed by automatic change of PID zone parameters, which are interlocked with the SV (or step SV for program control). PID zone value can be set in the PID group. Refer to “PID zone function” on p. 49. • <i>NoNE</i> : Not used • <i>USE</i> : Used 	Not used
	SV rise rate <ul style="list-style-type: none"> • Sets SV rise rate (rising value for 1 minute). Setting to 0 or 0.0 disables the function. • Setting range: 0 to 10000°C/min (°F/min) Thermocouple, RTD input with a decimal point: 0.0 to 1000.0°C/min (°F/min) DC voltage, current input: 0 to 10000/min (The placement of the decimal point follows the selection.) 	0°C/minute

Character	Name, Function, Setting range	Default value
	SV fall rate <ul style="list-style-type: none"> • Sets SV fall rate (falling value for 1 minute). Setting to 0 or 0.0 disables the function. • Setting range: 0 to 10000°C/min (°F/min) Thermocouple, RTD input with a decimal point: 0.0 to 1000.0°C/min (°F/min) DC voltage, current input: 0 to 10000/min (The placement of the decimal point follows the selection.) 	0°C/minute
	Indication when output OFF <ul style="list-style-type: none"> • Selects the indication when control output is OFF. • OFF□□: OFF indication • Roff□□: No indication • PV□□: PV indication • PVAL□□: PV indication+Any event from EVT1 to EVT5 output 	OFF indication
	Backlight <ul style="list-style-type: none"> • Selects the display to backlight. • ALL□□: All (displays and indicators) are backlit. • PV□□: Only PV display is backlit. • SV□□: Only SV display is backlit. • Ac□□: Only Action indicators are backlit. • PV SV□□: PV and SV displays are backlit. • PV Ac□□: PV display and Action indicators are backlit. • SV Ac□□: SV display and Action indicators are backlit. 	All are backlit
	PV color <ul style="list-style-type: none"> • Selects PV display color. See “PV display color selection” on p.50. • GRN□□: Green • REd□□: Red • oR□□: Orange • ALGR□□: When any alarm output from EVT1 to EVT5 is ON, PV color turns from green to red. • ALoR□□: When any alarm output from EVT1 to EVT5 is ON, PV color turns from orange to red. • PVGR□□: PV color changes continuously (Orange → Green → Red). • APGR□□: PV color changes continuously (Orange → Green → Red), and simultaneously when any alarm output from EVT1 to EVT5 is ON (Red). 	Red
	PV color range <ul style="list-style-type: none"> • When PVGR□□ (PV color changes continuously) or APGR□□ (PV color changes continuously + Any alarm output from EVT1 to EVT5 is ON) is selected during PV color selection, the value of green PV color range can be set. See “PV display color selection” on p.50. • Setting range: 0.1 to 200.0°C (°F), DC voltage, current input: 1 to 2000 (The placement of the decimal point follows the selection.) 	5.0°C

Character	Name, Function, Setting range	Default value
	Backlight time <ul style="list-style-type: none"> Sets time to backlight from no operation status until backlight is switched off. When set to 0, the backlight remains ON. Backlight relights by pressing any key while backlight is OFF. Setting range: 0 to 99 minutes 	0 minutes
	Bar graph <ul style="list-style-type: none"> Selects the MV or DV indication on the bar graph. (See p.51.) MV : MV (manipulated variable) indication DV : DV (deviation) indication NONE : No indication 	MV indication
	Deviation unit <ul style="list-style-type: none"> Sets amount of deviation for the positive (or negative) side of one division of the bar graph. (See p.51.) Setting range: 1 to Converted value of 20% of the input span 	1°C

[PID zone function]

When PID zone function “Used” is selected, and if SV (or Step SV for the program control) is lower than PID zone value, the control is performed with PID zone parameters of the relevant PID zone value.

If the next PID zone value is lower than the current one, the next PID zone parameters will not be effective.

During program control, the currently performing step SV is applicable to the PID zone. In the case of (Fig. 7.3.9-1), “SV: 150°C” is higher than “PID zone value 1: 100°C”, and lower than “PID zone value 2: 200°C”, so control is performed using PID zone parameters of PID zone value 2.

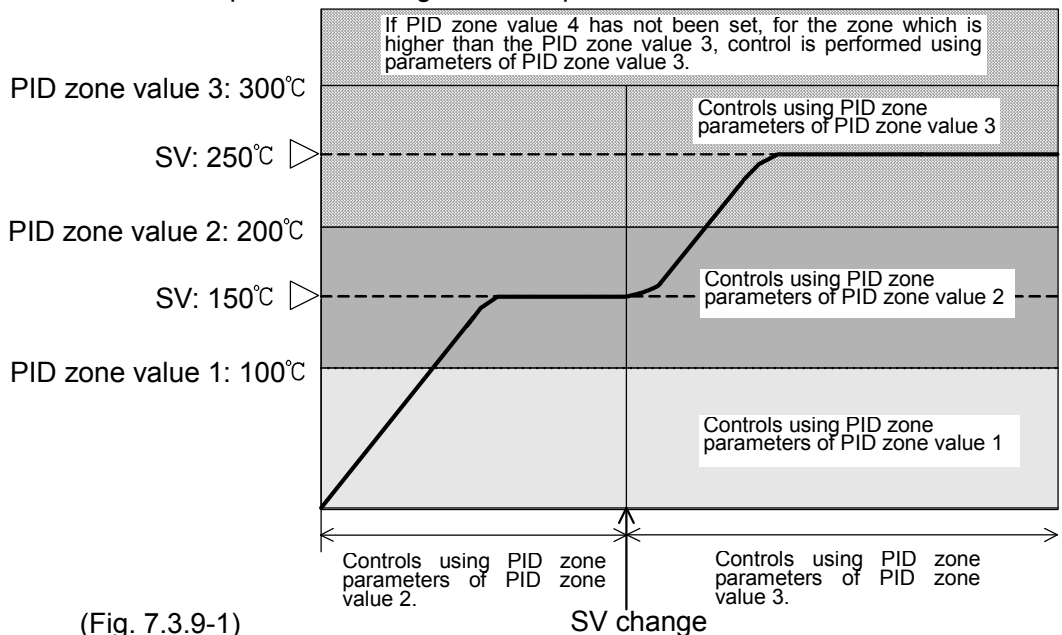

As PID zone value 4 has not been set, even in the case SV is higher than PID zone value 3, control is performed using PID zone parameters of PID zone value 3.



(Fig. 7.3.9-1)

[PV display color selection]

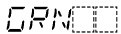
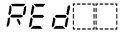
(Table 7.3.9-1)

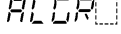
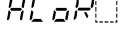
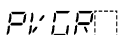
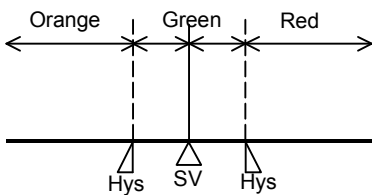
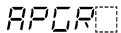
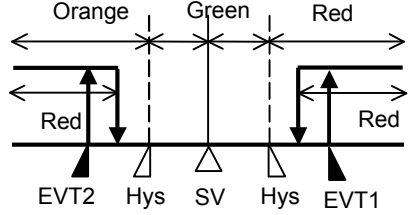
PV color selection		PV color
	Green	Constantly green
	Red	Constantly red
	Orange	Constantly orange
	When any alarm output from EVT1 to EVT5 is ON: Green → Red	When alarm output OFF: Green When any alarm output from EVT1 to EVT5 is ON, the PV color turns from green to red.
	When any alarm output from EVT1 to EVT5 is ON: Orange → Red	When alarm output OFF: Orange When any alarm output from EVT1 to EVT5 is ON, the PV color turns from orange to red.
	PV color changes continuously (Orange → Green → Red)	PV color changes depending on the color range setting. <ul style="list-style-type: none"> • PV is lower than [SV-PV color range]: Orange • PV is within [SV±PV color range]: Green • PV is higher than [SV+PV color range]: Red  <p>Hys: Set point of PV color range (Fig. 7.3.9-2)</p>
	PV color changes continuously (Orange → Green → Red), and at the same time any alarm output from EVT1 to EVT5 is ON (Red).	PV color changes depending on the color range setting. When any alarm output from EVT1 to EVT5 is ON, the PV display turns red. <ul style="list-style-type: none"> • PV is lower than [SV-PV color range]: Orange • PV is within [SV±PV color range]: Green • PV is higher than [SV+PV color range]: Red • Any alarm output from EVT1 to EVT5 is ON: Red  <p>Hys : Set point of PV color range EVT1: EVT1 value (High limit alarm) EVT2: EVT2 value (Low limit alarm) (Fig. 7.3.9-3)</p>

[Bar graph selection]

MV or DV are indicated on the bar graph.

With MV indication, if Heating/Cooling control output is added, bar graph indication for OUT1 MV and OUT2 MV differs as shown below.

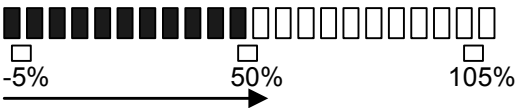
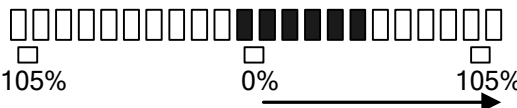
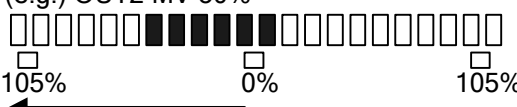
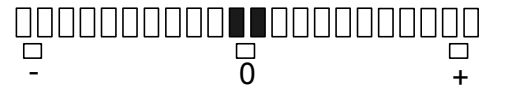
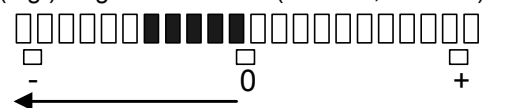
Function	Contents	Indication
MV indication	Scale is -5 to 105%, and bars light increasingly to the right in accordance with the OUT1 MV.	<p>(e.g.) OUT1 MV 50%</p>  <p>Light increasingly to the right in accordance with the OUT1 MV.</p>
MV indication (when Heating/Cooling control output is added.)	<p>Scale shows that center is 0%, the right end (OUT1 MV) is 105%, and the left end (OUT2 MV) is 105%.</p> <p>Bars for OUT1 MV light increasingly to the right from the center.</p> <p>Bars for OUT2 MV light increasingly to the left from the center.</p>	<p>(e.g.) OUT1 MV 50%</p>  <p>Light increasingly to the right in accordance with the OUT1 MV.</p> <p>(e.g.) OUT2 MV 50%</p>  <p>Light increasingly to the left in accordance with the OUT2 MV.</p>
DV indication	<p>In the case of deviation zero (0), central 2 bars light.</p> <p>For positive deviation, bars light increasingly to the right.</p> <p>For negative deviation, bars light increasingly to the left.</p>	<p>When deviation unit is set to 1: (e.g.) Deviation 0 (SV=200, PV=200)</p>  <p>Central 2 bars light.</p> <p>(e.g.) Negative deviation (SV=200, PV=196)</p>  <p>4 bars of deviation except the central bar light increasingly to the left in accordance with the deviation.</p>

8. Settings

There are 2 setting methods for this controller; Simplified setting, Group selection

8.1 Simplified setting method

Simplified setting method, which is effective for the Fixed value control, is the same method as when setting standard Shinko controllers.

8.1.1 SV setting mode

To enter the SV setting mode, press the **MODE** key once in the PV/SV display mode.

If Set value memory function is selected during Event input allocation, only the memory number selected via terminal connection can be set.

To set other Set value memory number, select it again by connecting terminals.

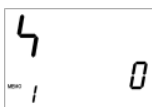

Character	Name, Function, Setting range	Default value
	SV <ul style="list-style-type: none"> • Sets SV (desired value). • Setting range: Scaling low limit to Scaling high limit 	0°C



8.1.2 Event setting mode





To enter the Event setting mode, press the **MODE** key while pressing the **△** key in the PV/SV display mode.

If Set value memory function is selected during Event input allocation, only the memory number selected via terminal connection can be set.

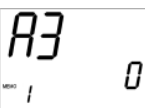
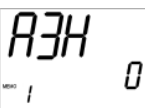
To set other Set value memory number, select it again by connecting terminals.

Character	Name, Function, Setting range	Default value
	EVT1 alarm value <ul style="list-style-type: none"> • Sets EVT1 alarm value. Setting the value to 0 or 0.0 disables the function (except Process high and Process low alarm). Not available if No event is selected or if items other than Alarm output is selected during Event output EVT1 allocation. • Setting range: Refer to (Table 8.1.2-1) on p.55. 	0°C
	EVT1 high limit alarm value <ul style="list-style-type: none"> • Sets EVT1 high limit alarm value. Setting the value to 0 or 0.0 disables the function (except Process high and Process low alarm). Not available if No event or items other than Alarm output is selected during Event output EVT1 allocation. For the independent alarms such as High/Low limits independent, High/Low limit range independent and High/Low limits with standby independent, the EVT alarm value matches the low limit side, and EVT high limit alarm value matches the high limit side. • Setting range: Refer to (Table 8.1.2-1) on p.55. 	0°C

Character	Name, Function, Setting range	Default value
	<p>EVT2 alarm value</p> <ul style="list-style-type: none"> • Sets EVT2 alarm value. <p>Setting the value to 0 or 0.0 disables the function (except Process high and Process low alarm).</p> <p>Not available if No event or items other than Alarm output is selected during Event output EVT2 allocation.</p> <ul style="list-style-type: none"> • Setting range: Refer to (Table 8.1.2-1) on p.55. 	0°C
	<p>EVT2 high limit alarm value</p> <ul style="list-style-type: none"> • Sets EVT2 high limit alarm value. <p>Setting the value to 0 or 0.0 disables the function (except Process high and Process low alarm).</p> <p>Not available if No event or items other than Alarm output is selected during Event output EVT2 allocation.</p> <p>For the independent alarms such as High/Low limits independent, High/Low limit range independent and High/Low limits with standby independent, the EVT alarm value matches the low limit side, and EVT high limit alarm value matches the high limit side.</p> <ul style="list-style-type: none"> • Setting range: Refer to (Table 8.1.2-1) on p.55. 	0°C
	<p>EVT3 alarm value</p> <ul style="list-style-type: none"> • Sets EVT3 alarm value. <p>Setting the value to 0 or 0.0 disables the function (except Process high and Process low alarm).</p> <p>Not available if No event or items other than Alarm output is selected during Event output EVT3 allocation</p> <ul style="list-style-type: none"> • Setting range: Refer to (Table 8.1.2-1) on p.55. 	0°C
	<p>EVT3 high limit alarm value</p> <ul style="list-style-type: none"> • Sets EVT3 high limit alarm value. <p>Setting the value to 0 or 0.0 disables the function (except Process high and Process low alarm).</p> <p>Not available if No event or items other than Alarm output is selected during Event output EVT3 allocation.</p> <p>For the independent alarms such as High/Low limits independent, High/Low limit range independent and High/Low limits with standby independent, the EVT alarm value matches the low limit side, and EVT high limit alarm value matches the high limit side.</p> <ul style="list-style-type: none"> • Setting range: Refer to (Table 8.1.2-1) on p.55. 	0°C

Character	Name, Function, Setting range	Default value
	<p>EVT4 alarm value</p> <ul style="list-style-type: none"> • Sets EVT4 alarm value. <p>Setting the value to 0 or 0.0 disables the function (except Process high and Process low alarm).</p> <p>Not available if No event or items other than Alarm output is selected during Event output EVT4 allocation.</p> <ul style="list-style-type: none"> • Setting range: Refer to (Table 8.1.2-1) on p.55. 	<p>0°C</p>
	<p>EVT4 high limit alarm value</p> <ul style="list-style-type: none"> • Sets EVT4 high limit alarm value. <p>Setting the value to 0 or 0.0 disables the function (except Process high and Process low alarm).</p> <p>Not available if No event or items other than Alarm output is selected during Event output EVT4 allocation.</p> <p>For the independent alarms such as High/Low limits independent, High/Low limit range independent and High/Low limits with standby independent, the EVT alarm value matches the low limit side, and EVT high limit alarm value matches the high limit side.</p> <ul style="list-style-type: none"> • Setting range: Refer to (Table 8.1.2-1) on p.55. 	<p>0°C</p>
	<p>EVT5 alarm value</p> <ul style="list-style-type: none"> • Sets EVT5 alarm value. <p>Setting the value to 0 or 0.0 disables the function (except Process high and Process low alarm).</p> <p>Not available if No event or items other than Alarm output is selected during Event output EVT5 allocation.</p> <ul style="list-style-type: none"> • Setting range: Refer to (Table 8.1.2-1) on p.55. 	<p>0°C</p>
	<p>EVT5 high limit alarm value</p> <ul style="list-style-type: none"> • Sets EVT5 high limit alarm value. <p>Setting the value to 0 or 0.0 disables the function (except Process high and Process low alarm).</p> <p>Not available if No event or items other than Alarm output is selected during Event output EVT5 allocation.</p> <p>For the independent alarms such as High/Low limits independent, High/Low limit range independent and High/Low limits with standby independent, the EVT alarm value matches the low limit side, and EVT high limit alarm value matches the high limit side.</p> <ul style="list-style-type: none"> • Setting range: Refer to (Table 8.1.2-1) on p.55. 	<p>0°C</p>

(Table 8.1.2-1)

Alarm type	Setting range
High limit (deviation setting)	-(Input span) to input span ^{°C(°F)} *1
Low limit (deviation setting)	-(Input span) to input span ^{°C(°F)} *1
High/Low limits (deviation setting)	0 to input span ^{°C(°F)} *1
High/Low limits independent (deviation setting)	0 to input span ^{°C(°F)} *1
High/Low limit range (deviation setting)	0 to input span ^{°C(°F)} *1
High/Low limit range independent (deviation setting)	0 to input span ^{°C(°F)} *1
Process high	Input range low limit to input range high limit value *2
Process low	Input range low limit to input range high limit value *2
High limit with standby (deviation setting)	-(Input span) to input span ^{°C(°F)} *1
Low limit with standby (deviation setting)	-(Input span) to input span ^{°C(°F)} *1
High/Low limits with standby (deviation setting)	0 to input span ^{°C(°F)} *1
High/Low limits with standby independent (deviation setting)	0 to input span ^{°C(°F)} *1







*1: For DC voltage, current input, the input span is the same as the scaling span.

*2: For DC voltage, current input, input range low (or high) limit value is the same as scaling low (or high) limit value.

8.1.3 PID setting mode

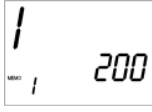
To enter the PID setting mode, press the **MODE** key 3sec while pressing the ∇ key in the PV/SV display mode.

If PID zone function "Used" is selected, PID zone parameters depends on the SV. PID zone numbers are indicated on the MEMO/STEP display.

Character	Name, Function, Setting range	Default value
	OUT1 proportional band <ul style="list-style-type: none"> Sets the proportional band for OUT1. OUT1 becomes ON/OFF action when set to 0 or 0.0. Setting range: 0 to Input span$^{\circ}$C ($^{\circ}$F) (DC voltage, current input: 0.0 to 1000.0%) 	10 $^{\circ}$ C
	OUT2 proportional band <ul style="list-style-type: none"> Sets the proportional band for OUT2. OUT2 becomes ON/OFF action when set to 0.0. Not available if D\square option is not added, or if OUT1 is in ON/OFF action. Setting range: 0.0 to 10.0 times (Multiplying factor to OUT1 proportional band) 	1.0 times
	Integral time <ul style="list-style-type: none"> Sets integral time for OUT1. Setting the value to 0 disables the function. Not available if OUT1 is in ON/OFF action. Auto-reset can be performed when PD is control action (I=0). Setting range: 0 to 3600 seconds 	200sec
	Derivative time <ul style="list-style-type: none"> Sets derivative time for OUT1. Setting the value to 0 disables the function. Not available if OUT1 is in ON/OFF action. Setting range: 0 to 1800 seconds 	50sec
	ARW <ul style="list-style-type: none"> Sets anti-reset windup (ARW) for OUT1. Available only when PID is control action. Setting range: 0 to 100% 	50%
	Manual reset <ul style="list-style-type: none"> Sets the reset value manually. Available only when P or PD is control action. Setting range: \pm10000 DC voltage, current input: The placement of the decimal point follows the selection. 	0 $^{\circ}$ C

Character	Name, Function, Setting range	Default value
	OUT1 rate-of-change <ul style="list-style-type: none"> • Sets changing value of OUT1 MV for 1 second. Setting the value to 0 disables the function. Not available if OUT1 is in ON/OFF action. See “OUT1 rate-of-change” on p.57. • Setting range: 0 to 100%/second 	0%/second

[OUT1 rate-of-change]

For Heating control, if PV is lower than SV, output is generally turned from OFF to ON as shown in (Fig. 8.1.3-1).

If OUT1 rate-of-change is set, the output can be changed by the rate-of-change (Fig. 8.1.3-2). This control is suitable for high temperature heaters (which are made from molybdenum, tungsten or platinum, etc., and used at approx. 1500 to 1800°C) which are easily burnt out from turning on electricity rapidly.

- Usual output
- Output when Output rate-of-change is set

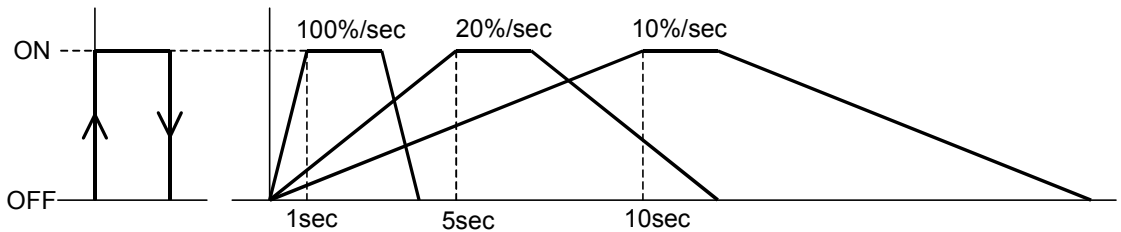

(Fig. 8.1.3-1)

(Fig. 8.1.3-2)

8.2 Group selection

There are 4 groups to be set for the controller; SV, Event group, PID group, AT group and Engineering group.

Select a group with the **SET** key, and set each item in the group with the **MODE** key.

PV display	Group	Setting items
G_4	• SV, Event group (Fixed value control)	• SV, Event (EVT1 to EVT5) (Fixed value control)
	• Program pattern group (Program control)	• Step SV, Step time, Wait value, Event (EVT1 to EVT5) (Program control)
G_PID	PID group	PID parameters
G_AT	AT group	AT/Auto-reset Perform/Cancel, AT bias
G_ENG	Engineering group	Input parameters, Output parameters, Event output parameters, Program parameters, Other functions



For details of the Engineering group, see pages 28 to 51.



8.2.1 SV, Event group (for Fixed value control)





Sets SV, Event (EVT1 to EVT5) in this group.

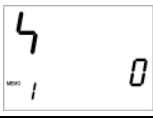

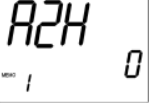

If Set value memory function is selected during Event input allocation, setting items in this group can be set for the selected memory numbers.

To enter the SV, Event group, follow the procedures below.

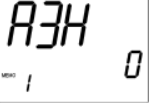
- (1)  Press the **SET** key once in the PV/SV display mode.
The unit proceeds to the SV, Event group.
- (2)  Press the **MODE** key once. The unit proceeds to the SV1 setting.

Character	Name, Function, Setting range	Default value
	SV1 • Sets SV1 (desired value). • Setting range: Scaling low limit to Scaling high limit	0°C
	EVT1 alarm value • Sets EVT1 alarm value. Setting the value to 0 or 0.0 disables the function (except Process high and low alarm). Not available if No event or setting items other than alarm outputs are selected during Event output EVT1 allocation • Setting range: Refer to (Table 8.1.2-1) on p.55.	0°C

Character	Name, Function, Setting range	Default value
	EVT1 high limit alarm value <ul style="list-style-type: none"> Sets EVT1 high limit alarm value. Setting the value to 0 or 0.0 disables the function (except Process high and Process low alarm). Not available if No event or setting items other than alarm outputs are selected during Event output EVT1 allocation. For the independent alarms such as High/Low limits independent and High/Low limit range independent, the EVT alarm value matches the low limit side, and EVT high limit alarm value matches the high limit side. <ul style="list-style-type: none"> Setting range: Refer to (Table 8.1.2-1) on p. 55. 	0°C
	EVT2 alarm value <ul style="list-style-type: none"> Sets EVT2 alarm value. Setting the value to 0 or 0.0 disables the function (except Process high and Process low alarm). Not available if No event or setting items other than alarm outputs are selected during Event output EVT2 allocation <ul style="list-style-type: none"> Setting range: Refer to (Table 8.1.2-1) on p. 55. 	0°C
	EVT2 high limit alarm value <ul style="list-style-type: none"> Sets EVT2 high limit alarm value. Setting the value to 0 or 0.0 disables the function (except Process high and Process low alarm). Not available if No event or setting items other than alarm outputs are selected during Event output EVT2 allocation. For the independent alarms such as High/Low limits independent and High/Low limit range independent, the EVT alarm value matches the low limit side, and EVT high limit alarm value matches the high limit side. <ul style="list-style-type: none"> Setting range: Refer to (Table 8.1.2-1) on p. 55. 	0°C
	EVT3 alarm value <ul style="list-style-type: none"> Sets EVT3 alarm value. Setting the value to 0 or 0.0 disables the function (except Process high and Process low alarm). Not available if No event or setting items other than alarm outputs are selected during Event output EVT3 allocation <ul style="list-style-type: none"> Setting range: Refer to (Table 8.1.2-1) on p. 55. 	0°C
	EVT3 high limit alarm value <ul style="list-style-type: none"> Sets EVT3 high limit alarm value. Setting the value to 0 or 0.0 disables the function (except Process high and Process low alarm). Not available if No event or setting items other than alarm outputs are selected during Event output EVT3 allocation. For the independent alarms such as High/Low limits independent and High/Low limit range independent, the EVT alarm value matches the low limit side, and EVT high limit alarm value matches the high limit side. <ul style="list-style-type: none"> Setting range: Refer to (Table 8.1.2-1) on p. 55. 	0°C

Character	Name, Function, Setting range	Default value
	EVT4 alarm value <ul style="list-style-type: none"> Sets EVT4 alarm value. Setting the value to 0 or 0.0 disables the function (except Process high and Process low alarm). Not available if No event or setting items other than alarm outputs are selected during Event output EVT4 allocation <ul style="list-style-type: none"> Setting range: Refer to (Table 8.1.2-1) on p. 55. 	0°C
	EVT4 high limit alarm value <ul style="list-style-type: none"> Sets EVT4 high limit alarm value. Setting the value to 0 or 0.0 disables the function (except Process high and Process low alarm). Not available if No event or setting items other than alarm outputs are selected during Event output EVT4 allocation. For the independent alarms such as High/Low limits independent and High/Low limit range independent, the EVT alarm value matches the low limit side, and EVT high limit alarm value matches the high limit side. <ul style="list-style-type: none"> Setting range: Refer to (Table 8.1.2-1) on p. 55. 	0°C
	EVT5 alarm value <ul style="list-style-type: none"> Sets EVT5 alarm value. Setting the value to 0 or 0.0 disables the function (except Process high and Process low alarm). Not available if No event or setting items other than alarm outputs are selected during Event output EVT5 allocation <ul style="list-style-type: none"> Setting range: Refer to (Table 8.1.2-1) on p. 55. 	0°C
	EVT5 high limit alarm value <ul style="list-style-type: none"> Sets EVT5 high limit alarm value. Setting the value to 0 or 0.0 disables the function (except Process high and Process low alarm). Not available if No event or setting items other than alarm outputs are selected during Event output EVT5 allocation. For the independent alarms such as High/Low limits independent and High/Low limit range independent, the EVT alarm value matches the low limit side, and EVT high limit alarm value matches the high limit side. <ul style="list-style-type: none"> Setting range: Refer to (Table 8.1.2-1) on p. 55. 	0°C
	Up to 15 files of the Set value memory selected during Event input allocation can be set.	
	EVT5 high limit alarm value <ul style="list-style-type: none"> Sets EVT5 high limit alarm value. Setting the value to 0 or 0.0 disables the function (except Process high and Process low alarm). Not available if No event or setting items other than alarm outputs are selected during Event output EVT5 allocation. For the independent alarms such as High/Low limits independent and High/Low limit range independent, the EVT alarm value matches the low limit side, and EVT high limit alarm value matches the high limit side. <ul style="list-style-type: none"> Setting range: Refer to (Table 8.1.2-1) on p. 55. 	0°C

8.2.2 Program pattern group (for program control)

Sets Step SV, Step time, Wait value and Event (EVT1 to EVT5) in this group. A maximum of 15 steps of program pattern can be created.

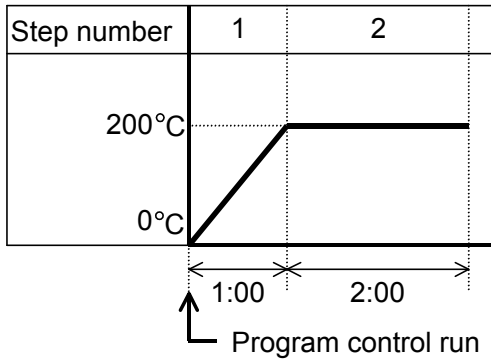

This program pattern shows that the temperature rises to 200°C for 1 hour, and stays at 200°C for 2 hours.

In this case, Step 1 SV is 200°C and Step 1 time is 1 hour.

(Fig. 8.2.2-1)

[Wait function]

During the program control run, the program does not proceed to the next step until the deviation between PV and SV enters $SV \pm \text{Wait value}$ at the end of step. The STEP indicator flashes while the Wait function is working.

The Wait function is released on the condition that:

When program pattern is rising: PV is higher than $SV - \text{Wait value}$

When program pattern is falling: PV is lower than $SV + \text{Wait value}$

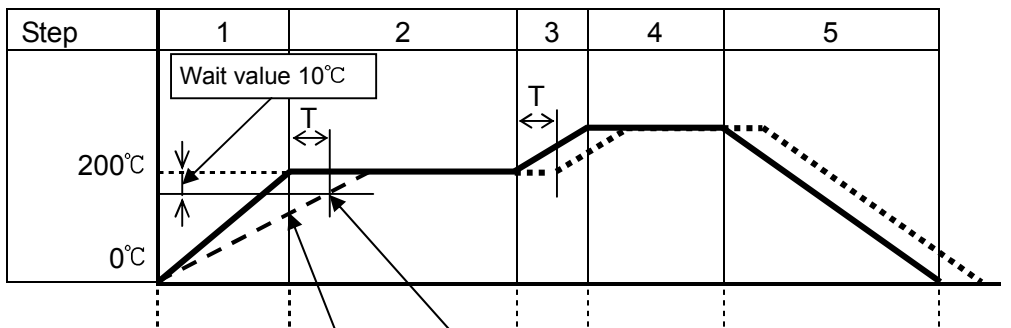

If PV becomes higher than 190°C, the wait function will be released and proceed to Step 2.

As PV is not in the range of $SV \pm \text{Wait value}$, the unit is in Wait status, and does not proceed to Step 2. The STEP indicator flashes during Wait action (T time).

--- : PV

— : Program pattern





..... : Program pattern delayed by T due to the Wait function





(Fig. 8.2.2-2)

To enter the Program pattern group, follow the procedures below.

- (1) Press the **SET** key once in the PV/SV display mode.
The unit proceeds to the Program pattern group.
- (2) Press the **MODE** key once.
The unit proceeds to Step1 SV setting.

Character	Name, Function, Setting range	Default value
	Step 1 SV <ul style="list-style-type: none"> • Sets Step 1 SV (desired value) • Setting range: Scaling low limit value to Scaling high limit value 	0°C
	Step 1 time <ul style="list-style-type: none"> • Sets Step 1 time. • Setting range: 00:00 to 99:59 	00:00
	Step 1 wait value <ul style="list-style-type: none"> • Sets Step 1 wait value. This function prevents the step from proceeding to the next one until PV enters the range of SV ± Wait value regardless of the step time. Setting the value to 0 or 0.0 disables the function. • Setting range: 0 to Converted value of 20% of the input span 	0°C
	Step 1 EVT1 alarm value <ul style="list-style-type: none"> • Sets Step1 EVT1 alarm value. Setting the value to 0 or 0.0 disables the function (except Process high and Process low alarm). Not available if No event or setting items other than alarm outputs are selected during Event output EVT1 allocation • Setting range: Refer to (Table 8.1.2-1) on p. 55. 	0°C
	Step 1 EVT1 high limit alarm value <ul style="list-style-type: none"> • Sets Step 1 EVT1 high limit alarm value. Setting the value to 0 or 0.0 disables the function (except Process high and Process low alarm). Not available if No event or setting items other than alarm outputs are selected during Event output EVT1 allocation. For the independent alarms such as High/Low limits independent alarm and High/Low limit range independent alarm, the EVT alarm value matches the low limit side, and EVT high limit alarm value matches the high limit side. • Setting range: Refer to (Table 8.1.2-1) on p. 55. 	0°C

Character	Name, Function, Setting range	Default value
	Step 1 EVT2 alarm value <ul style="list-style-type: none"> Sets Step 1 EVT2 alarm value. Setting the value to 0 or 0.0 disables the function (except Process high and Process low alarm). Not available if No event or setting items other than alarm outputs are selected during Event output EVT2 allocation <ul style="list-style-type: none"> Setting range: Refer to (Table 8.1.2-1) on p. 55. 	0°C
	Step 1 EVT2 high limit alarm value <ul style="list-style-type: none"> Sets Step 1 EVT2 high limit alarm value. Setting the value to 0 or 0.0 disables the function (except Process high and Process low alarm). Not available if No event or setting items other than alarm outputs are selected during Event output EVT2 allocation. For the independent alarms such as High/Low limits independent alarm and High/Low limit range independent alarm, the EVT alarm value matches the low limit side, and EVT high limit alarm value matches the high limit side. <ul style="list-style-type: none"> Setting range: Refer to (Table 8.1.2-1) on p. 55. 	0°C
	Step 1 EVT3 alarm value <ul style="list-style-type: none"> Sets Step 1 EVT3 alarm value. Setting the value to 0 or 0.0 disables the function (except Process high and Process low alarm). Not available if No event or setting items other than alarm outputs are selected during Event output EVT3 allocation <ul style="list-style-type: none"> Setting range: Refer to (Table 8.1.2-1) on p. 55. 	0°C
	Step 1 EVT3 high limit alarm value <ul style="list-style-type: none"> Sets Step 1 EVT3 high limit alarm value. Setting the value to 0 or 0.0 disables the function (except Process high and Process low alarm). Not available if No event or setting items other than alarm outputs are selected during Event output EVT3 allocation. For the independent alarms such as High/Low limits independent alarm and High/Low limit range independent alarm, the EVT alarm value matches the low limit side, and EVT high limit alarm value matches the high limit side. <ul style="list-style-type: none"> Setting range: Refer to (Table 8.1.2-1) on p. 55. 	0°C
	Step 1 EVT4 alarm value <ul style="list-style-type: none"> Sets Step 1 EVT4 alarm value. Setting the value to 0 or 0.0 disables the function (except Process high and Process low alarm). Not available if No event or setting items other than alarm outputs are selected during Event output EVT4 allocation <ul style="list-style-type: none"> Setting range: Refer to (Table 8.1.2-1) on p. 55. 	0°C

Character	Name, Function, Setting range	Default value
	<p>Step 1 EVT4 high limit alarm value</p> <ul style="list-style-type: none"> • Sets Step 1 EVT4 high limit alarm value. <p>Setting the value to 0 or 0.0 disables the function (except Process high and Process low alarm).</p> <p>Not available if No event or setting items other than alarm outputs are selected during Event output EVT4 allocation.</p> <p>For the independent alarms such as High/Low limits independent alarm and High/Low limit range independent alarm, the EVT alarm value matches the low limit side, and EVT high limit alarm value matches the high limit side.</p> <ul style="list-style-type: none"> • Setting range: Refer to (Table 8.1.2-1) on p. 55. 	0°C
	<p>Step 1 EVT5 alarm value</p> <ul style="list-style-type: none"> • Sets Step 1 EVT5 alarm value. <p>Setting the value to 0 or 0.0 disables the function (except Process high and Process low alarm).</p> <p>Not available if No event or setting items other than alarm outputs are selected during Event output EVT5 allocation</p> <ul style="list-style-type: none"> • Setting range: Refer to (Table 8.1.2-1) on p. 55. 	0°C
	<p>Step 1 EVT5 high limit alarm value</p> <ul style="list-style-type: none"> • Sets Step 1 EVT5 high limit alarm value. <p>Setting the value to 0 or 0.0 disables the function (except Process high and Process low alarm).</p> <p>Not available if No event or setting items other than alarm outputs are selected during Event output EVT5 allocation.</p> <p>For the independent alarms such as High/Low limits independent alarm and High/Low limit range independent alarm, the EVT alarm value matches the low limit side, and EVT high limit alarm value matches the high limit side.</p> <ul style="list-style-type: none"> • Setting range: Refer to (Table 8.1.2-1) on p. 55. 	0°C
	<p>Step 1 data consists of from Step 1 SV to Step 1 EVT5 high limit alarm value.</p> <p>Can be set continuously up to Step15.</p>	
	<p>Step 15 EVT5 high limit alarm value</p> <ul style="list-style-type: none"> • Sets Step 15 EVT5 high limit alarm value. <p>Setting the value to 0 or 0.0 disables the function (except Process high and Process low alarm).</p> <p>Not available if No event or setting items other than alarm outputs are selected during Event output EVT5 allocation.</p> <p>For the independent alarms such as High/Low limits independent alarm and High/Low limit range independent alarm, the EVT alarm value matches the low limit side, and EVT high limit alarm value matches the high limit side.</p> <ul style="list-style-type: none"> • Setting range: Refer to (Table 8.1.2-1) on p. 55. 	0°C



Step SV from Step 1 to Step 15 and set values from EVT1 to EVT5 are common to SV from Set value memory number 1 to 15 and set values from EVT1 to EVT5.





8.2.3 PID group



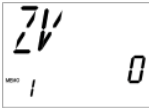

PID parameters can be set in this group.

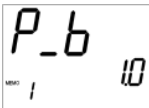
PID group is common to Fixed value control and program control.

To enter the PID group, follow the procedures below.

- (1)  Press the **SET** key twice in the PV/SV display mode.
The unit proceeds to the PID group.
- (2)  Press the **MODE** key once.
If PID zone function “Not used” is selected during PID zone function selection, the unit proceeds to OUT1 proportional band 1 setting.
 If PID zone function “Used” is selected during PID zone function selection, the unit proceeds to PID zone value 1 setting.

Character	Name, Function, Setting range	Default value
	PID zone value 1 <ul style="list-style-type: none"> • Sets Reference value 1 to change PID zone parameters of the PID zone function. Not available if PID zone function “Not used” is selected during PID zone function selection. One zone consists of from “PID zone value 1” to “OUT1 rate-of-change 1”. When SV is lower than Reference value 1, control is performed with these PID zone parameters. • Setting range: Scaling low limit value to Scaling high limit value 	0°C
	OUT1 proportional band 1 <ul style="list-style-type: none"> • Sets the proportional band 1 for OUT1. OUT1 becomes ON/OFF action when set to 0 or 0.0. • Setting range: 0 to Input span °C(°F) DC voltage, current input: 0.0 to 1000.0% 	10°C
	OUT2 proportional band 1 <ul style="list-style-type: none"> • Sets the proportional band 1 for OUT2. OUT2 becomes ON/OFF action when set to 0.0. Available only when D□ option is added. • Setting range: 0.0 to 10.0 times (multiplying factor to OUT1 proportional band) 	1.0 times
	Integral time 1 <ul style="list-style-type: none"> • Sets integral time 1 for OUT1. Setting the value to 0 disables the function. Auto-reset can be performed when PD is control action (I=0). • Setting range: 0 to 3600 seconds 	200sec

Character	Name, Function, Setting range	Default value
	Derivative time 1 <ul style="list-style-type: none"> • Sets derivative time 1 for OUT1. Setting the value to 0 disables the function. • Setting range: 0 to 1800 seconds 	50sec
	ARW 1 <ul style="list-style-type: none"> • Sets ARW 1 (anti-reset windup 1) for OUT1. • Setting range: 0 to 100% 	50%
	Manual reset 1 <ul style="list-style-type: none"> • Sets the reset value 1 manually. • Setting range: ± 10000 DC voltage, current input: The placement of the decimal point follows the selection.	0°C
	OUT1 rate-of-change 1 <ul style="list-style-type: none"> • Sets OUT1 rate-of-change 1 (changing value of OUT1 MV for 1 second). Setting the value to 0 disables the function. See “OUT1 rate-of-change” on p.57. • Setting range: 0 to 100%/second 	0%/second
	One zone consists of “PID zone value 1” to “OUT1 rate-of-change 1”, if PID zone function “Used” is selected during PID zone function selection. Can be set continuously up to 5 zones.	
	OUT1 rate-of-change 5 <ul style="list-style-type: none"> • Sets OUT1 rate-of-change 5 (changing value of OUT1 MV for 1 second). Setting the value to 0 disables the function. See “OUT1 rate-of-change” on p.57. • Setting range: 0 to 100%/second 	0%/ second

8.2.4 AT group



AT/Auto-reset Perform/Cancel, AT bias can be set in this group.

AT group is common to Fixed value control and program control.

During ON/OFF action or PI action, the unit cannot proceed to any setting items in this group.

If PID zone function “Used” is selected, and if control action of the PID zone number used for control is ON/OFF or PI, the unit cannot proceed to any setting items in this group.

To enter the AT group, follow the procedures below.

- (1)  Press the **SET** key 3 times in the PV/SV display mode.
The unit proceeds to the AT group.
- (2)  Press the **MODE** key once.
The unit proceeds to the AT/Auto-reset selection.

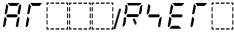
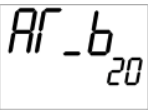
Character	Name, Function, Setting range	Default value
	AT/Auto-reset <ul style="list-style-type: none"> • Selects AT Perform/Cancel (PID action) or Auto-reset Perform/Cancel (P, PD action). • If PID zone function “Used” is selected, values such as P, I, D, ARW of the PID block number which are used for control are changed after auto-tuning is finished. • If the auto-tuning is cancelled during the process, P, I, D and ARW values revert to the values before auto-tuning was performed. • If the auto-tuning is not finished after 4 hours, it is cancelled automatically. • Auto-reset is cancelled in approximately 4 minutes. It cannot be released while performing this function. • - - - - - : AT/Auto-reset Cancel  : AT/Auto-reset Perform If AT/Auto-reset Perform is selected, and the MODE key is pressed, the unit reverts to the PV/SV display mode. 	- - - - -
	AT bias <ul style="list-style-type: none"> • Sets bias value for the auto-tuning. Refer to “11. Auto-tuning” on pages 77, 78. Not available for DC voltage, current input • Setting range: 0 to 50°C (0 to 100°F) With a decimal point: 0.0 to 50.0°C (0.0 to 100.0°F) 	20°C

9. Operation

9.1 Starting operation

After the unit is mounted to the control panel and wiring is completed, operate the unit following the procedures below.

(1) Turn the power supply to the unit ON.

After the power is turned on, the PV display indicates the input type, and the SV display indicates the input range high limit value (thermocouple, RTD input) or scaling high limit value (DC voltage, current input) for approximately 3 seconds.

See (Table 9.1-1).

(Table 9.1-1)

Sensor input	°C		°F	
	PV display	SV display	PV display	SV display
K	K□□□C	□1370	K□□□F	□2498
	K□□.C	□4000	K□□.F	□7520
J	J□□□C	□1000	J□□□F	□1800
R	R□□□C	□1760	R□□□F	□3200
S	S□□□C	□1760	S□□□F	□3200
B	B□□□C	□1820	B□□□F	□3300
E	E□□□C	□1800	E□□□F	□1500
T	T□□□C	□4000	T□□.F	□7500
N	N□□□C	□1300	N□□□F	□2300
PL-II	PL2□C	□1390	PL2□F	□2500
C(W/Re5-26)	C□□□C	□23.15	C□□□F	□4200
Pt100	Pt□□.C	□8500	Pt□□.F	□15620
JPt100	JPt□.C	□5000	JPt□.F	□9320
Pt100	Pt□□□C	□850	Pt□□□F	□1562
JPt100	JPt□□C	□500	JPt□□F	□932
Pt100	Pt□□.C	□1000	Pt□□.F	□2120
Pt100	Pt□□.C	□5000	Pt□□.F	□9320
4 to 20mA DC	420mA	Scaling high limit value		
0 to 20mA DC	020mA			
0 to 10mV DC	□10mV			
-10 to 10mV DC	-10mV			
0 to 50mV DC	□50mV			
0 to 100mV DC	100mV			
0 to 1V DC	0010V			
0 to 5V DC	0050V			
1 to 5V DC	1050V			
0 to 10V DC	0100V			

During this time, all outputs and indicators are in OFF status.

Control will then start indicating as follows.

• Fixed value control status

The PV display indicates PV (process variable), The SV display indicates SV (desired value), and the MEMO/STEP display indicates the memory number if selected during the Event input allocation.

- **When Control output OFF function is working**

The PV display indicates [FF]. (Indication of the PV display depends on the selection during “Indication when output OFF” mode.)

- **Program control standby status**

The PV display indicates the PV (process variable), and the SV and MEMO/STEP displays go off.

- **When program control is operating**

The PV display indicates PV (process variable), the SV display indicates the Step SV, and the MEMO/STEP display indicates the step number.

(2) Set up the unit.

Refer to “6. Operation flowchart” and “7. Setup”.

Setup should occur in the Engineering group before using this controller, to set the Input type, Event output type, Control action, etc. according to the users’ conditions. If the users’ specification is the same as the default value of the instrument, it is not necessary to set up the controller. Proceed to Step (3).

(3) Input each set value.

Refer to “6. Operation flowchart” and “8. Settings”.

(4) Turn the load circuit power ON.

The controller works as follows depending on the control (Fixed value control/Program control).

- **Fixed value control**

Control action starts so as to keep the control target at the SV (desired value).

- **Program control**

Perform program control

To perform Program control, press the $\frac{\text{RUN}}{\text{STOP}}$ key.

Program control starts (“PV start” is used).

PV start: When the program control starts, the step SV and time are advanced to the PV, and the control starts.

If “Program start temperature” has been set in the Program group, Program control starts from the preset temperature.

While the Wait function is working, the STEP indicator flashes.

Stop program control

To stop Program control, press the $\frac{\text{RUN}}{\text{STOP}}$ key for 1 second.

Program control stops, and the unit reverts to Program control standby.

Advance function (proceeds to the next step during program operation)

If the \triangle key is pressed for 1sec during program control, it interrupts the performing step, and proceeds to the next step. While Wait function is working, the Wait function is cancelled, and the unit proceeds to the next step.

Control after power restoration

If power failure occurs during the Program control and is restored, control stops (standby), continues or is suspended depending on the selection during “Power restore action”.

(e.g.) When setting the SV (desired value) to 100°C in the Fixed value control.

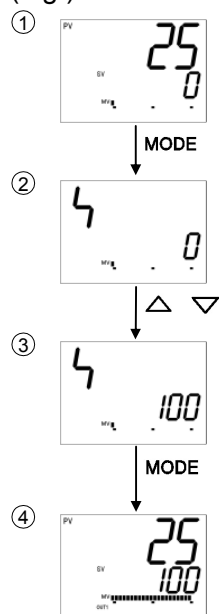

Proceed to the SV setting mode.

Press the **MODE** key in the PV/SV display mode.

The unit proceeds to the SV setting.

Set SV.

Set SV with the **△** or **▽** key.

Register the SV.

Press the **MODE** key to register the SV.

The unit reverts to the PV/SV display mode.

Control starts.

9.2 Control output OFF function

This is a function to pause the control action or turn the control output of the unused instrument of the plural units OFF even if the power to the instrument is supplied.

This function is available for Fixed value control.

To turn the control output OFF, press the $\frac{\text{RUN}}{\text{STOP}}$ key for approximately 1 second in the PV/SV display mode.

[OFF] is indicated on the PV display while the function is working.

(However, indication on the PV display depends on the selection during “Indication when output OFF”.)

Once the control output OFF function is enabled, the function cannot be released even if the power to the instrument is turned OFF and ON again.

To cancel the function, press the $\frac{\text{RUN}}{\text{STOP}}$ key again for approx. 1 second.

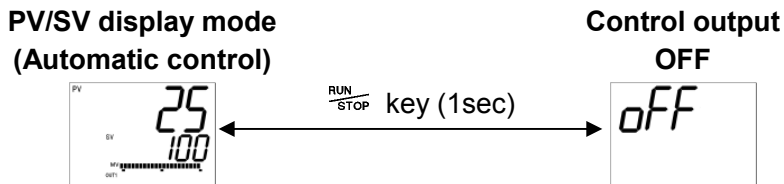

9.3 Switching Auto/Manual control

By pressing the $\frac{A/M}{B/MODE}$ key in the PV/SV display mode, Auto/Manual control can be switched.

If control action is switched from automatic to manual and vice versa, balance/bumpless function works to prevent a sudden change in manipulated variables.

When automatic control is switched to manual control, the MEMO/STEP display indicates [ν^M].

The output MV (manipulated variable) can be increased or decreased by pressing the \triangle or ∇ key to perform the control.

By pressing the $\frac{A/M}{B/MODE}$ key again, the unit reverts to the PV/SV display mode (automatic control).

Whenever the power to the controller is turned on, automatic control starts.

Switching from Automatic to Manual control, and vice versa

PV/SV display mode (Automatic control)

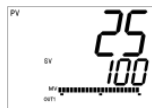

$\frac{A/M}{B/MODE}$ key

Manual control

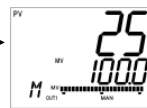

Increases or decreases output MV (manipulated variable) with the \triangle , ∇ key.

9.4 Indicating MV (manipulated variable) and remaining step time (program control)

To indicate output MV (manipulated variable), press the $MODE$ key for approximately 3 seconds in the PV/SV display mode. The SV/MV/TIME display indicates output MV and the MEMO/STEP display indicates [ν^M].

SV and TIME of the SV/MV/TIME indicator are unlit, and MV of the SV/MV/TIME indicator is lit. If the $MODE$ key is pressed again during fixed value control, the unit reverts to the PV/SV display mode.

If the $MODE$ key is pressed during program control, remaining step time is indicated on the SV/MV/TIME display.

SV and MV of the SV/MV/TIME indicator are unlit, and TIME of the SV/MV/TIME indicator is lit. By pressing the $MODE$ key again, the unit reverts to the PV/SV display mode.

During Fixed value control:

PV/SV display mode (Automatic control)



$MODE$ key (3sec)

$MODE$ key

Output MV indication



9.5 AT/Auto-reset Perform, AT Cancel

In order to set each value of P, I, D and ARW automatically, the auto-tuning process should be made to fluctuate to obtain an optimal value. (See pages 77, 78.)

AT/Auto-reset Perform and AT Cancel can be set during the "AT/Auto-reset selection" in the AT group.

Auto-reset can be performed when the unit is in P or PD control action. (See p.77.)

Auto-reset ends 4 minutes after starting. It cannot be released while performing this function.

How to perform AT/Auto-reset

- (1) Press the **SET** key 3 times in the PV/SV display mode.
The unit proceeds to the AT group.
- (2) Press the **MODE** key. The unit proceeds to AT/Auto-reset selection.
- (3) Select AT/Auto-reset “Perform [*AT* /REVERSE]” with the **△** key, and press the **MODE** key.
The unit returns to the PV/SV display mode, and AT/Auto-reset will initiate. While performing AT/Auto-reset, the AT indicator is flashing. When auto-tuning is not finished after 4 hours, it is automatically cancelled. During AT, if Direct/Reverse action is switched in the Event input (“003” Direct/Reverse action in Event input allocation), the AT stops. Auto-reset is cancelled in approximately 4 minutes. It cannot be released while performing this function.

How to cancel AT

- (1) Press the **SET** key 3 times in the PV/SV display mode.
The unit proceeds to the AT group.
- (2) Press the **MODE** key.
The unit proceeds to AT/Auto-reset selection.
- (3) Select AT/Auto-reset “Cancel [- - - -]” with the **▽** key, and press the **MODE** key for 3 seconds. Auto-tuning will stop, and the unit will revert to the PV/SV display mode. If Auto-tuning is cancelled during this process, each value of P, I, D and ARW reverts to the values before the Auto-tuning was performed.

AT Perform/Cancel (PID action):

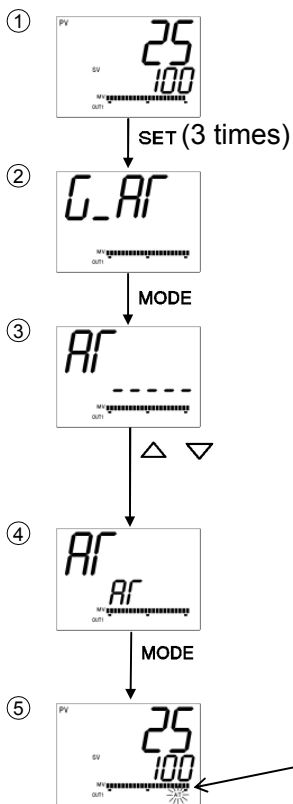

Proceed to the AT group.

Press the **SET** key 3 times in the PV/SV display mode.
The unit proceeds to the AT group.

Proceed to the AT/Auto-reset selection.

Press the **MODE** key.
The unit proceeds to AT/Auto-reset selection.

Select AT Perform/Cancel.

Select “*AT* (AT Perform)” with the **△**, or select “- - - - (AT Cancel)” with the **▽**.

- - - - : AT Cancel

AT : AT Perform

Confirm AT Perform/Cancel.

If “AT Perform” is selected, press the **MODE** key.
If “AT Cancel” is selected, press the **MODE** key for 3sec.
The unit reverts to the PV/SV display mode.

AT Perform/Cancel





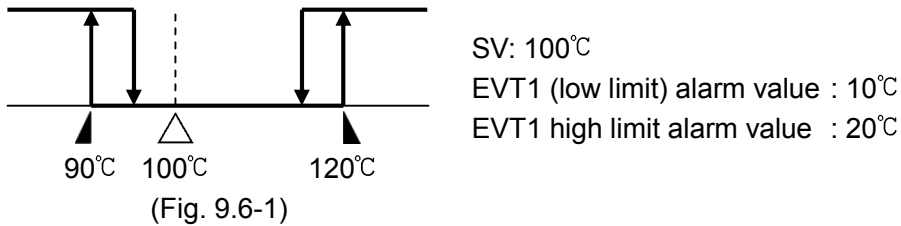

While AT is performing, the AT indicator flashes, and it goes off if AT is cancelled.

9.6 Using Event output as a High/Low limits independent alarm

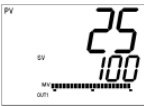
To use the Event output as a High/Low limits independent alarm, set as follows.
(e.g.)

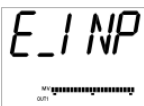
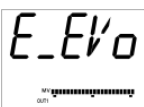

- (1) Select [Engineering group] – [Event output group] – [Event output EVT1 allocation] – [Alarm output; High/Low limits independent] in order.

- ①  **Proceed to the Engineering group.**
Press the **SET** key 4 times in the PV/SV display mode.
The unit proceeds to the Engineering group.
- ↓ SET (4 times)
- ②  **Proceed to the Input group.**
Press the **MODE** key.
The unit proceeds to the Input group.
- ↓ MODE
- ③  **Proceed to the Event output group.**
Press the **SET** key several times until Event output group characters appear.
- ↓ SET (several times)
- ④  **Proceed to the Event output EVT1 allocation.**
Press the **MODE** key.
The unit proceeds to Event output EVT1 allocation.
- ↓ MODE
- ⑤  **Select Event output EVT1 allocation.**
Select [004: Alarm output; High/Low limits independent] with the \triangle or ∇ key.
- ↓ \triangle ∇
- ⑥  **Confirm the Event output EVT1 allocation.**
Press the **MODE** key.
The unit proceeds to the Event output EVT1 alarm hysteresis setting.
- ↓ MODE
- ⑦  **Set Event output EVT1 alarm hysteresis.**
Use the \triangle or ∇ key for setting, and press the **MODE** key.
The unit proceeds to the Event output EVT1 alarm action delayed timer.
- ↓ MODE

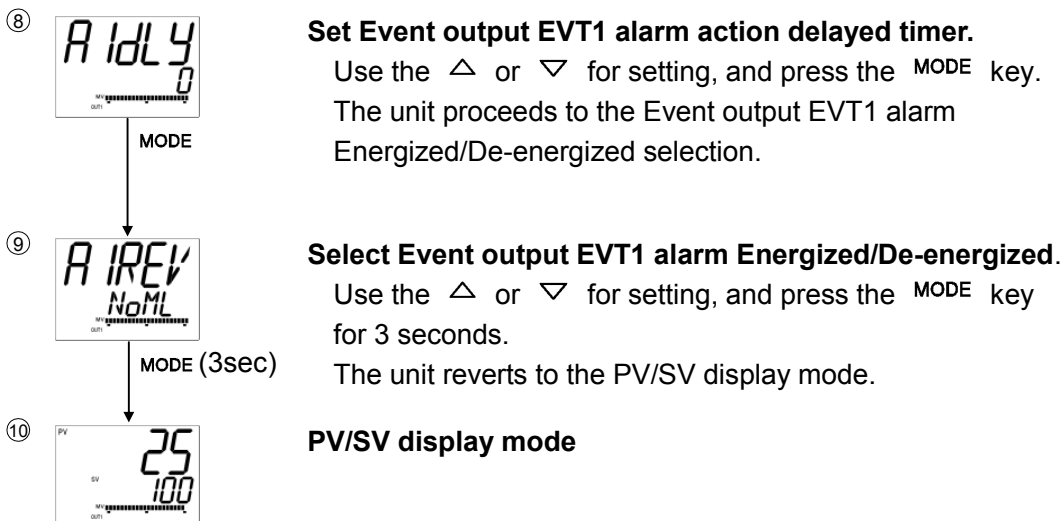

(2) Set EVT1 (low limit) alarm value and EVT1 high limit alarm value.

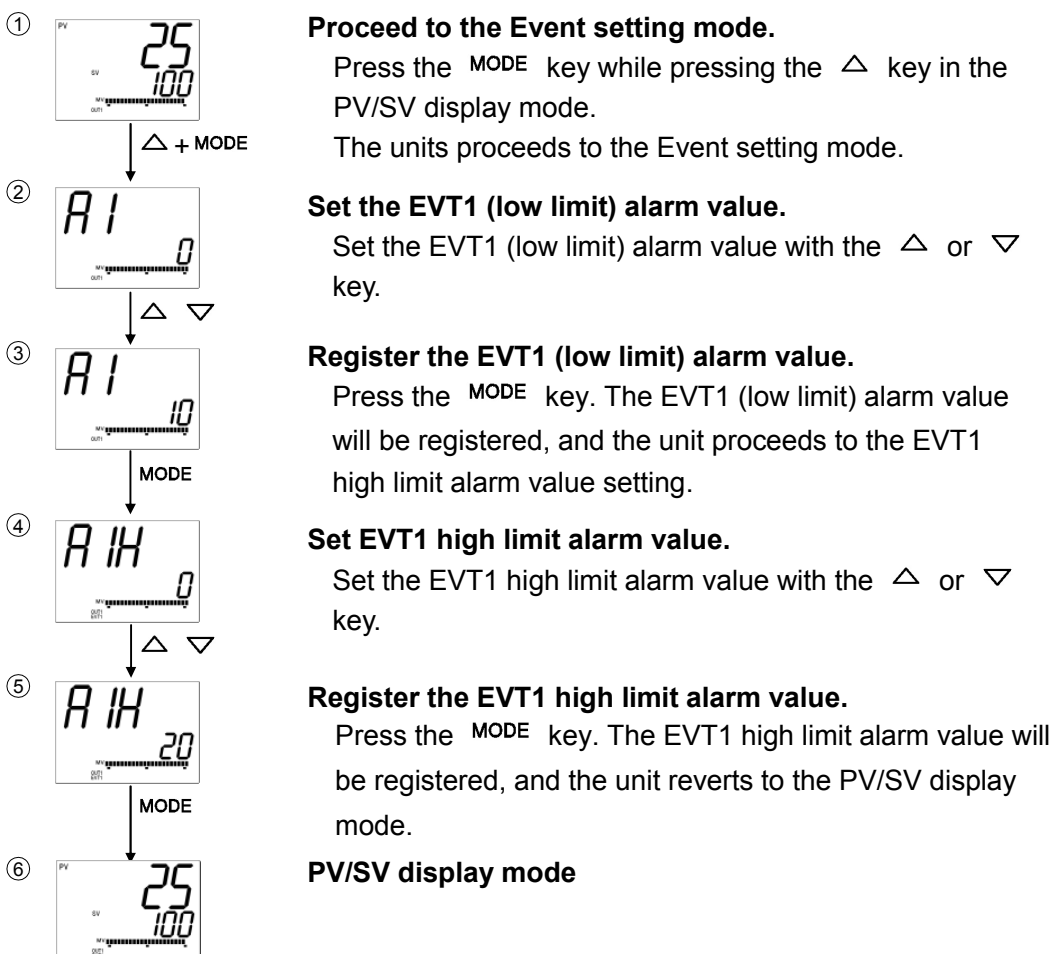

9.7 Set value memory function

If Set value memory function is selected during Event input EVI1 to EVI4 allocation, memory number can be selected by external operation. Up to 15 files with 13 pieces of data can be memorized. Control can be performed by selecting the desired file.

In one file, 13 pieces of data are included; SV (desired value), Step time, Wait value, EVT1 alarm value, EVT1 high limit alarm value, EVT2 alarm value, EVT2 high limit alarm value, EVT3 alarm value, EVT3 high limit alarm value, EVT4 alarm value, EVT4 high limit alarm value, EVT5 alarm value, EVT5 high limit alarm value.

If Set value memory function is selected for all from EVI1 to EVI4 during Event input EVI1 to EVI4 allocation, the memory number can be set by connecting terminals 11 through 15 as follows.

A maximum of 50 units of controllers can be connected in parallel.

Set value memory numbers by connecting terminals: [-: Closed(ON), O: Open(OFF)]

Set value memory No. Connecting terminals	1	2	3	4	5	6	7	8	9	10	11	12	13	14	15	(*)
11-15 [DI1(EVI1)-COM]	O	-	O	-	O	-	O	-	O	-	O	-	O	-	O	-
12-15 [DI2(EVI2)-COM]	O	O	-	-	O	O	-	-	O	O	-	-	O	O	-	-
13-15 [DI3(EVI3)-COM]	O	O	O	O	-	-	-	-	O	O	O	O	-	-	-	-
14-15 [DI4(EVI4)-COM]	O	O	O	O	O	O	O	O	-	-	-	-	-	-	-	-

(*): Works as Set value memory number 15.

If Set value memory function is selected for EVI1 and EVI2 during Event input EVI1 to EVI4 allocation: Set value memory number can be selected using terminals 11, 12 and 15 as shown below.

Set value memory numbers by connecting terminals: [-: Closed(ON), O: Open(OFF)]

Set value memory No. Connecting terminals	1	2	3	4
11-15 [DI1(EVI1)-COM]	O	-	O	-
12-15 [DI2(EVI2)-COM]	O	O	-	-

During setting mode or during AT performing, memory numbers cannot be changed by connecting terminals.

[Operation procedures]

Simplified setting

- (1) Select the Set value memory number by connecting terminals in the PV/SV display mode.
- (2) Set the following values;
 - SV (in the SV setting mode), EVT1 alarm value, EVT1 high limit alarm value, EVT2 alarm value, EVT2 high limit alarm value, EVT3 alarm value, EVT3 high limit alarm value, EVT4 alarm value, EVT4 high limit alarm value, EVT5 alarm value, EVT5 high limit alarm value (in the Event setting mode)

Group selection (Fixed value control)

- (1) Proceed to the desired setting item of Set value memory number to be set in the SV, Event group.
- (2) Set the following values;
 - SV, EVT1 alarm value, EVT1 high limit alarm value, EVT2 alarm value, EVT2 high limit alarm value, EVT3 alarm value, EVT3 high limit alarm value, EVT4 alarm value, EVT4 high limit alarm value, EVT5 alarm value, EVT5 high limit alarm value

[Registration complete]

- Each set value is registered in the file number displayed on the MEMO/STEP display.
- When any number is retrieved by connecting terminals, the selected number will be indicated, and the control is performed using the data (set values) of the indicated file number.
- To change set values, repeat the "Operation procedures" above.

10. Auto-reset

Auto-reset is performed to correct the offset at the point at which PV indication is stabilized within the proportional band during the PD action. Since the corrected value is internally memorized, it is not necessary to perform the auto-reset again as long as the process is the same. However, when OUT1 proportional band is set to 0 or 0.0, the corrected value is cleared.

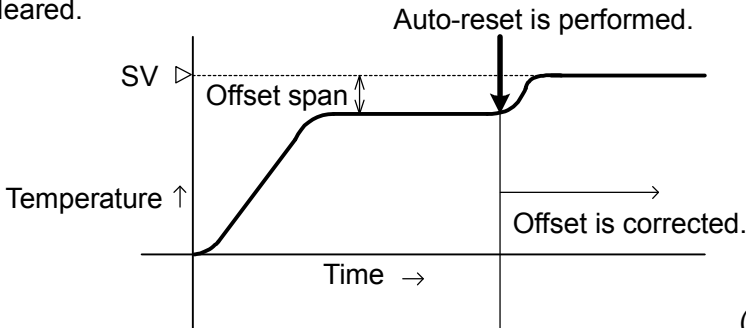

(Fig. 10-1)

11. Auto-tuning

In order to set each value of P, I, D and ARW automatically, the auto-tuning process should be made to fluctuate to obtain an optimal value. One of 3 types of fluctuation below is automatically selected.

For DC voltage, current input, the AT process will fluctuate around the SV for conditions of [1], [2] and [3]. (p.78)

! Notice

- Perform auto-tuning during the trial run.
- If PID zone function is set to "Used", perform AT in each PID zone.

In (Fig. 11-1), AT is performing at PID zone value 1 and PID zone value 2.

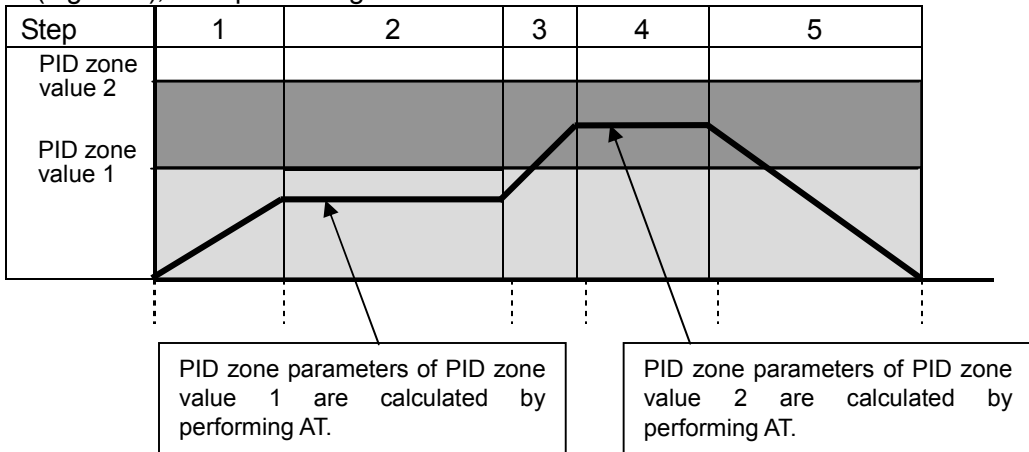

(Fig. 11-1)

- If Auto-tuning is cancelled during this process, each value of P, I, D and ARW reverts to the values before the Auto-tuning was performed.
- When auto-tuning is not finished after 4 hours, it is automatically cancelled.
- During AT, if Direct/Reverse action is switched in the Event input ("003" Direct/Reverse action in Event input allocation), the AT stops.
- During auto-tuning, none of the setting items can be set.
- If power failure occurs during the auto-tuning, the tuning stops.
- Sometimes the auto-tuning process will not fluctuate if auto-tuning is performed at or near room temperature. Therefore auto-tuning might not finish normally.

[1] In the case of a large difference between the SV and processing temperature as the temperature is rising

When AT bias is set to 20°C, the AT process will fluctuate at the temperature 20°C lower than the SV.

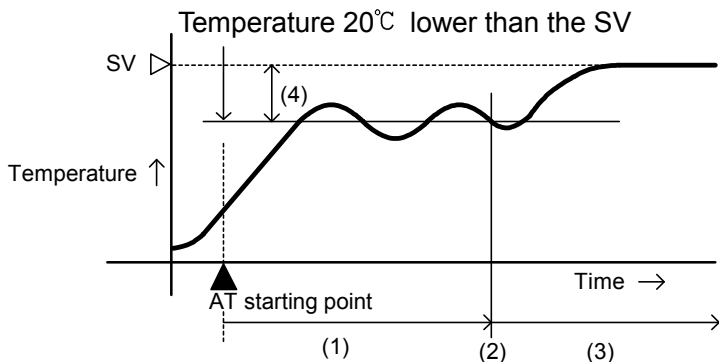

(Fig. 11-1)

- (1) Calculating PID constant
- (2) PID constant calculated
- (3) Controlled by the PID constant set by auto-tuning.
- (4) AT bias value

[2] When the control is stable

The AT process will fluctuate around the SV.

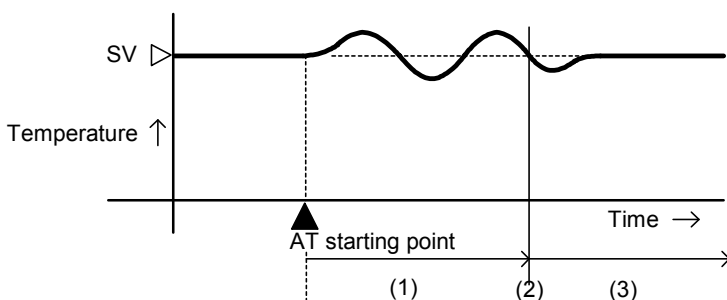

(Fig. 11-2)

- (1) Calculating PID constant
- (2) PID constant calculated
- (3) Controlled by the PID constant set by auto-tuning.

[3] In the case of a large difference between the SV and processing temperature as the temperature is falling

When AT bias is set to 20°C, the AT process will fluctuate at the temperature 20°C higher than the SV.

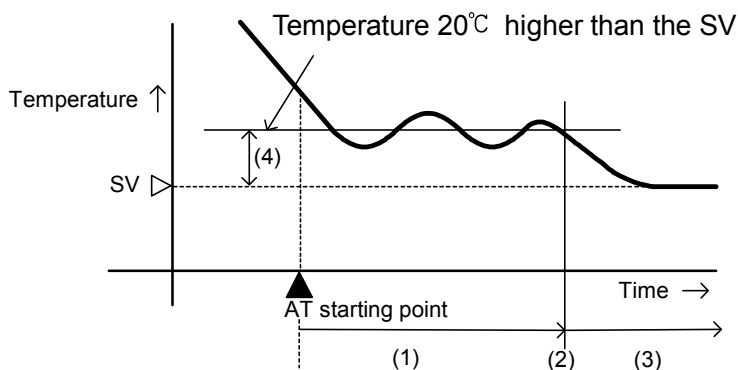

(Fig. 11-3)

- (1) Calculating PID constant
- (2) PID constant calculated
- (3) Controlled by the PID constant set by auto-tuning.
- (4) AT bias value

12. Action explanation

12.1 OUT1 action

	Heating (reverse) action			Cooling (direct) action		
Control action						
R/□						
S/□						
A/□						
Indicator (OUT1)						

: ON (lit) or OFF (unlit)

12.2 OUT1 ON/OFF action

	Heating (reverse) action		Cooling (direct) action	
Control action				
R/□				
S/□				
A/□				
Indicator (OUT1)				

: ON (lit) or OFF (unlit)

12.3 Alarm action

	High limit alarm	Low limit alarm
Alarm action	<p>The diagram shows a signal line with an ON level and an OFF level. A setpoint (SV) is marked with a triangle. Two limit values are marked: -EVT1 value and +EVT1 value. The signal is ON when the process value is above +EVT1 and below -EVT1. Hysteresis is shown as a gap between the ON and OFF levels. The signal is OFF when the process value is between -EVT1 and +EVT1.</p>	<p>The diagram shows a signal line with an ON level and an OFF level. A setpoint (SV) is marked with a triangle. Two limit values are marked: -EVT1 value and +EVT1 value. The signal is ON when the process value is below -EVT1 and above +EVT1. Hysteresis is shown as a gap between the ON and OFF levels. The signal is OFF when the process value is between -EVT1 and +EVT1.</p>
Alarm output	<p>+side </p> <p>- side </p>	<p>+side </p> <p>- side </p>
	High/Low limits alarm	High/Low limits independent alarm
Alarm action	<p>The diagram shows a signal line with ON and OFF levels. A setpoint (SV) is marked with a triangle. Two limit values are marked: EVT1 value and EVT1 value. The signal is ON when the process value is above the high limit and below the low limit. Hysteresis is shown as a gap between the ON and OFF levels. The signal is OFF when the process value is between the two limits.</p>	<p>The diagram shows a signal line with ON and OFF levels. A setpoint (SV) is marked with a triangle. Two limit values are marked: EVT1 low limit value and EVT1 high limit value. The signal is ON when the process value is above the high limit or below the low limit. Hysteresis is shown as a gap between the ON and OFF levels. The signal is OFF when the process value is between the two limits.</p>
Alarm output		
	High/ Low limit range alarm	High/ Low limit range independent
Alarm action	<p>The diagram shows a signal line with ON and OFF levels. A setpoint (SV) is marked with a triangle. Two limit values are marked: EVT1 value and EVT1 value. The signal is ON when the process value is above the high limit and below the low limit. Hysteresis is shown as a gap between the ON and OFF levels. The signal is OFF when the process value is between the two limits.</p>	<p>The diagram shows a signal line with ON and OFF levels. A setpoint (SV) is marked with a triangle. Two limit values are marked: EVT1 low limit value and EVT1 high limit value. The signal is ON when the process value is above the high limit or below the low limit. Hysteresis is shown as a gap between the ON and OFF levels. The signal is OFF when the process value is between the two limits.</p>
Alarm output		
	Process high alarm	Process low alarm
Alarm action	<p>The diagram shows a signal line with ON and OFF levels. A setpoint (SV) is marked with a triangle. A limit value is marked: EVT1 value. The signal is ON when the process value is above the limit. Hysteresis is shown as a gap between the ON and OFF levels. The signal is OFF when the process value is below the limit.</p>	<p>The diagram shows a signal line with ON and OFF levels. A setpoint (SV) is marked with a triangle. A limit value is marked: EVT1 value. The signal is ON when the process value is below the limit. Hysteresis is shown as a gap between the ON and OFF levels. The signal is OFF when the process value is above the limit.</p>
Alarm output		

	High limit alarm with standby	Low limit alarm with standby
Alarm action		
Alarm output	+ side - side	+ side - side
	High/Low limits with standby	High/Low limits with standby independent
Alarm action		
Alarm output		

- : EVT1 output terminals 9 and 10 are connected (ON).
- : EVT1 output terminals 9 and 10 are connected (ON) or disconnected (OFF).
- : EVT1 output terminals 9 and 10 are disconnected (OFF).
- : Standby functions.

- EVT1 value means EVT1 alarm value, and EVT1 hysteresis means EVT1 alarm hysteresis.
- EVT1 indicator lights when their output terminals 9 and 10 are connected (ON), and goes off when their output terminals 9 and 10 are disconnected (OFF).

For EVT2 to EVT5, read “EVT2 to EVT5” for “EVT1”.

EVT2 output (terminals 7 and 8) (For A3 option, use terminals 8 and 10.)

EVT3 output (terminals 7 and 10)

EVT4 output (terminals 29 and 30)

EVT5 output (terminals 28 and 30)

- For the alarm type (High limit alarm, High/Low limits alarm, High/Low limits independent, Process high alarm), alarm is activated when the indication is overscale, and the standby function is released for the alarms with standby function.

For the alarm type (Low limit alarm, High/Low limits alarm, High/Low limits independent, Process low alarm), alarm is activated when the indication is underscale, and the standby function is released for the alarms with standby function.

When the alarm action De-energized is selected, the output ON/OFF status acts conversely to the alarm action described above. (The Event indicator is the same as the action Energized)

	Energized	De-energized
Event indicator	Lights	Lights
Event output	ON	OFF

12.4 Heater burnout alarm action

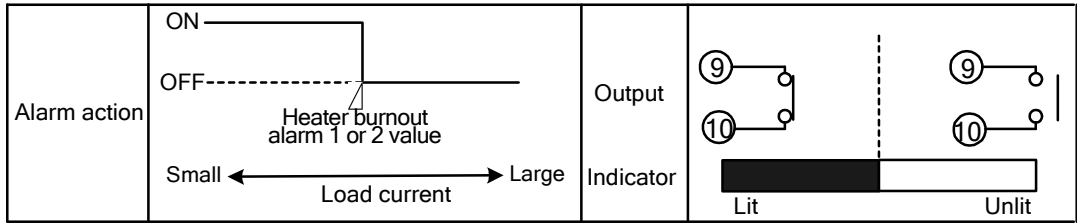

- EVT1 indicator lights when their output terminals 9 and 10 are connected (ON), and goes off when their output terminals 9 and 10 are disconnected (OFF). The following shows EVT2 to EVT5 terminals.
 EVT2 output (terminals 7 and 8) (For A3 option, use terminals 8 and 10.)
 EVT3 output (terminals 7 and 10)
 EVT4 output (terminals 29 and 30)
 EVT5 output (terminals 28 and 30)

12.5 OUT2 (Heating/Cooling control) action

Control action			
R/□	<p>Cycle action is performed according to deviation.</p>		
DR	<p>Cycle action is performed according to deviation.</p>		
S/□	<p>Cycle action is performed according to deviation.</p>		
DS	<p>Cycle action is performed according to deviation.</p>		
A/□	<p>Changes continuously according to deviation.</p>		
DA	<p>Changes continuously according to deviation.</p>		
Indicator (OUT1)			
Indicator (OUT2)			

- : ON (lit) or OFF (unlit)
- : Represents Heating action.
- : Represents Cooling action.

12.6 OUT2 (Heating/Cooling control) action (when setting dead band)

Control action			
R/□	<p>Cycle action is performed according to deviation.</p>		
DR	<p>Cycle action is performed according to deviation.</p>		
S/□	<p>Cycle action is performed according to deviation.</p>		
DS	<p>Cycle action is performed according to deviation.</p>		
A/□	<p>Changes continuously according to deviation.</p>		
DA	<p>Changes continuously according to deviation.</p>		
Indicator (OUT1)			
Indicator (OUT2)			

- : ON (lit) or OFF (unlit)
- : Represents Heating action.
- : Represents Cooling action.

12.7 OUT2 (Heating/Cooling control) action (when setting overlap band)

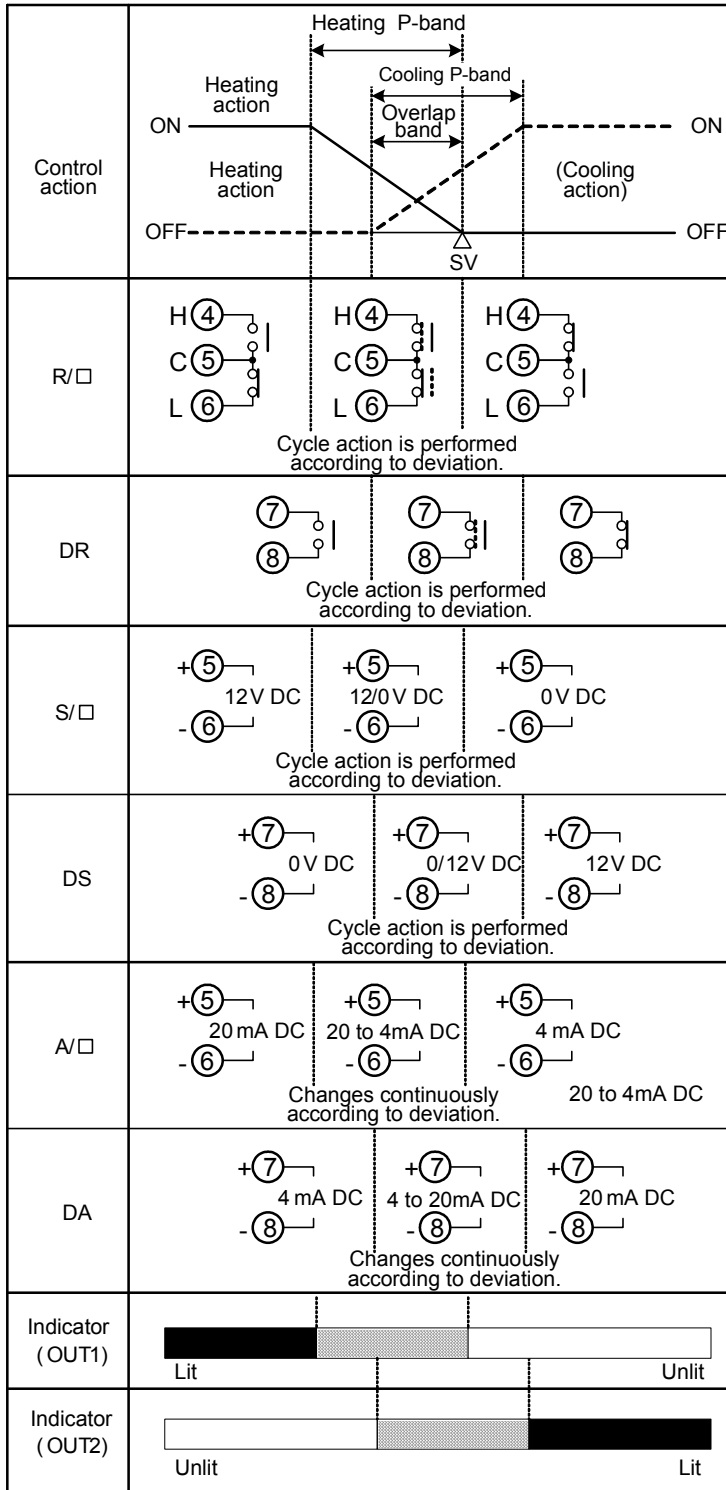

: ON (lit) or OFF (unlit)

: Represents Heating action.

: Represents Cooling action.

13. Specifications

13.1 Standard specifications

Rating

Input	Thermocouple: K, J, R, S, B, E, T, N, PL-II, C(W/Re5-26) External resistance, 100 Ω or less (However, B input: External resistance, 40 Ω or less)
RTD	: Pt100, JPt100, 3-wire system Allowable input lead wire resistance: 10 Ω or less per wire
DC current	: 0-20mA DC, 4-20mA DC Input impedance: 50 Ω Allowable input current, 50mA or less
DC voltage	: 0-10mV DC, -10-10mV DC, 0-50mV DC, 0-100mV DC, 0-1V DC Input impedance: 1M Ω or more Allowable input voltage: 5V DC or less Allowable signal source resistance: 2k Ω or less 0 to 10mV DC : 20 Ω or less -10 to 10mV DC : 40 Ω or less 0 to 50mV DC : 200 Ω or less 0 to 100mV DC : 200 Ω or less 0 to 1V DC : 2k Ω or less : 0-5V DC, 1-5V DC, 0-10V DC Input impedance: 100k Ω or more Allowable input voltage: 15V DC or less Allowable signal source resistance: 100 Ω or less
Supply voltage	: 100 to 240V AC 50/60Hz, 24V AC/DC 50/60Hz Allowable voltage fluctuation: 100 to 240V AC: 85 to 264V AC 24V AC/DC : 20 to 28V AC/DC

General structure

External dimensions	: ACD-13A: 96 x 96 x 100mm (W x H x D) ACR-13A: 48 x 96 x 100mm (W x H x D)
Mounting	: Flush
Material	: Flame-resistant resin (Case)
Color	: Black (Case)
Dust-proof/Drip-proof	: IP66
Display	
PV display	: 11-segment LCD 5-digit, backlight Red/Green/Orange Character size: 24.0 x 11.0 mm (H x W)
SV/MV/TIME display	: 11-segment LCD 5-digit, backlight Green Character size: 14.0 x 7.0 mm (H x W)
MV/DV bar graph	: 22-segment LCD bar graph, backlight Green
MEMO/STEP display	: 11-segment backlight LCD 2-digit, backlight Orange Character size: 10.0 x 5.0mm (H x W)
Action indicators	: Backlight Orange

Setting structure

Setting method	: Digital setting using membrane sheet key
-----------------------	--

Indicating performance

Reference accuracy:

Thermocouple : Within $\pm 0.2\%$ of each input span ± 1 digit,
However R, S input, -50 to 200°C (-58 to 392°F): Within $\pm 6^{\circ}\text{C}$ (12°F)
B input, 0 to 300°C (0 to 572°F): Accuracy is not guaranteed
K, J, E, T, N input, less than 0°C (32°F): Within $\pm 0.4\%$ of input span ± 1 digit

RTD : Within $\pm 0.1\%$ of each input span ± 1 digit

DC current : Within $\pm 0.2\%$ of each input span ± 1 digit

DC voltage : Within $\pm 0.2\%$ of each input span ± 1 digit

External setting input accuracy: Within $\pm 0.2\%$ of External setting input span

Cold junction temperature compensation accuracy: Within $\pm 1^{\circ}\text{C}$ at 0 to 50°C

Input sampling period: 0.125 seconds (0.25 seconds when EA□ or EV□ option is added)

Time accuracy: Within $\pm 1.0\%$ of the setting time

Control performance

Setting accuracy: Based on the Reference accuracy and Cold junction temperature compensation accuracy

Control action

PID action (with auto-tuning function)

PI action: When derivative time is set to 0

PD action (with Auto/Manual reset function): When integral time is set to 0

P action (with Auto/Manual reset function): When derivative and integral time are set to 0 .

ON/OFF action: When proportional band is set to 0 or 0.0

OUT1 proportional band : 0 to Input span $^{\circ}\text{C}$ ($^{\circ}\text{F}$)

DC voltage, current input: 0.0 to 1000.0%

(ON/OFF action when set to 0 or 0.0) (Default: 10°C)

Integral time : 0 to 3600sec . (OFF when set to 0) (Default: 200sec .)

Derivative time : 0 to 1800sec . (OFF when set to 0) (Default: 50sec .)

OUT1 proportional cycle : 1 to 120sec . (Default: 30sec for Relay contact,
 3sec for Non-contact voltage, Not available for DC current)

ARW : 0 to 100% (Default: 50%)

OUT1 ON/OFF action hysteresis: 0.1 to 1000.0°C ($^{\circ}\text{F}$) (Default: 1.0°C)

DC voltage, current input: 1 to 10000 (The placement of the decimal point follows the selection.)

OUT1 high limit setting : 0 to 100% (DC current: -5 to 105%) (Default: 100%)

OUT1 low limit setting : 0 to 100% (DC current: -5 to 105%) (Default: 0%)

Control output (OUT1)

Relay contact : $1\text{a}1\text{b}$,

Control capacity 3A 250V AC (resistive load)

1A 250V AC (inductive load $\cos\phi=0.4$)

Electrical life, $100,000$ cycles

Non-contact voltage (For SSR drive): 12V DC $\pm 15\%$

Maximum 40mA (short circuit protected)

DC current : 4 to 20mA DC (Resolution: $1/12000$)

Load resistance, Maximum 600Ω

Standard functions

EVT1 output

Output is turned ON or OFF depending on the conditions selected during Event output allocation.

Output: Relay contact 1a

Control capacity, 3A 250V AC (resistive load)

1A 250V AC (inductive load $\cos\phi=0.4$)

Electrical life, 100,000 cycles

EVT2 output

Output is turned ON or OFF depending on the conditions selected during Event output allocation.

If D□ or P option is added, EVT2 output is disabled.

Output: Relay contact 1a

Control capacity, 3A 250V AC (resistive load)

1A 250V AC (inductive load $\cos\phi=0.4$)

Electrical life, 100,000 cycles

Alarm action

When Alarm action (Energized) is selected during Event output allocation, the alarm action point is set by the \pm deviation from the SV (except Process alarm). When the input goes outside the range, the output turns ON or OFF (in the case of High/Low limit range alarm).

When the alarm action is set as De-energized, the output acts conversely.

Types: High limit alarm, Low limit alarm, High/Low limits alarm, High/Low limits independent, High/Low limit range, High/Low limit range independent, Process high alarm, Process low alarm, High limit alarm with standby, Low limit alarm with standby, High/Low limits with standby, High/Low limits with standby independent
One type can be selected from 24 types (with status Energized/De-energized) and No event.

(Default value: No event)

Refer to "12.3 Alarm action" on pages 81, 82.

Set value : Default value: 0

Setting accuracy: Based on the Reference accuracy and Cold junction temperature compensation accuracy

Action : ON/OFF action

Hysteresis: Thermocouple, RTD input: 0.1 to 1000.0°C (°F)
(Default value: 1.0°C)

DC voltage, current input: 1 to 10000 (The placement of the decimal point follows the selection)

Output : EVT output for which alarm is selected during Event output allocation

Loop break alarm

Detects the breaking status on the loop such as heater burnout, sensor burnout or actuator trouble.

Setting range : Loop break alarm time; 0 to 200minutes

Loop break alarm span; 0 to 150°C(°F), 0.0 to 150.0°C(°F),

DC voltage, current input: 0 to 1500 (The placement of the decimal point follows the selection)

Output : EVT output for which Loop break alarm is selected during Event output allocation

Insulation, Dielectric strength
Circuit insulation configuration

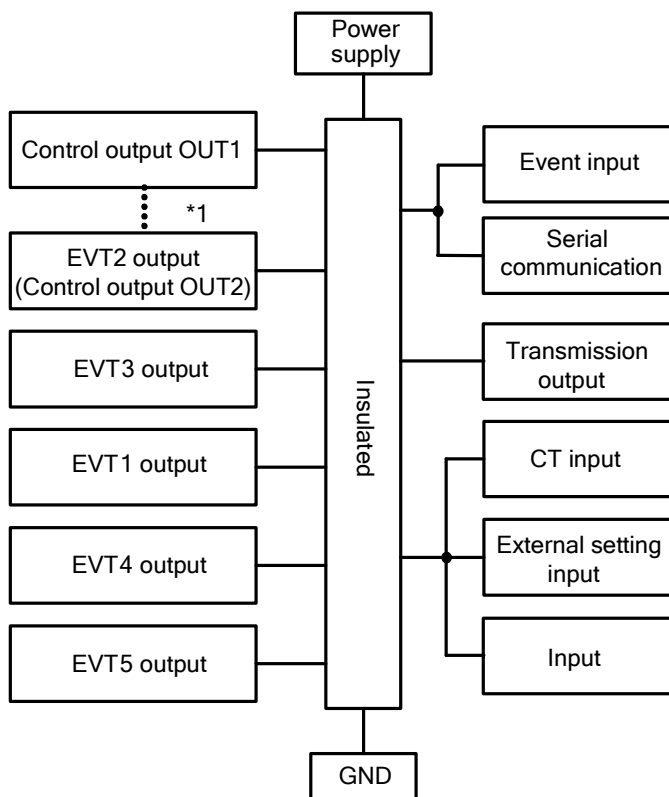

*1 When OUT1 and OUT2 are non-contact voltage or DC current output, OUT1 is not insulated from OUT2.

Insulation resistance: 10MΩ or more, at 500V DC

Dielectric strength:

Between power terminal and ground (GND): 1.5kV AC for 1 minute

Between input terminal and ground (GND) : 1.5kV AC for 1 minute

Between input terminal and power terminal : 1.5kV AC for 1 minute

Attached functions:

[Sensor correction]

[Set value lock]:

Lock 1, Lock 2, Lock 3, Lock 4

[Auto/Manual control switching]

Auto/Manual control can be switched using the $\frac{A/M}{B/MODE}$ key in the PV/SV display mode.

[Program control function]

Number of steps: 15

Program control starts or stops with the $\frac{RUN}{STOP}$ key.

If Pattern end output is selected during Event output allocation (pages 35-37), the Event output to which Pattern end output is allocated is turned ON when program is finished.

If the \triangle key is pressed for 1 sec while program is operational, the Advance function initiates, interrupting the performing step, and proceeds to the next step.

[Set value ramp function]

When the SV (desired value) is adjusted, it approaches the new SV by the preset rate-of-change ($^{\circ}\text{C}/\text{min}$, $^{\circ}\text{F}/\text{min}$).

When the power is turned on, the control starts from the PV (process variable) and approaches the SV by the rate-of-change.

SV rise rate, SV fall rate:

Setting range: 0 to 10000 $^{\circ}\text{C}/\text{min}$ ($^{\circ}\text{F}/\text{min}$), or 0.0 to 1000.0 $^{\circ}\text{C}/\text{min}$ ($^{\circ}\text{F}/\text{min}$)

DC voltage, current input: 0 to 10000 (The placement of the decimal point follows the selection)

Setting the value to 0 disables the function.

(Default: 0 $^{\circ}\text{C}/\text{min}$)

[Power failure countermeasure]

The setting data is backed up in the non-volatile IC memory.

[Self-diagnosis]

The CPU is monitored by a watchdog timer, and if the CPU's status becomes abnormal, the controller is switched to warm-up status with all outputs OFF.

[Automatic cold junction temperature compensation] (only thermocouple input type)

This detects the temperature at the connecting terminal between the thermocouple and the instrument, and always maintains the same status as if the reference junction is located at 0 $^{\circ}\text{C}$ (32 $^{\circ}\text{F}$).

[Burnout]

If the thermocouple or RTD input is burnt out, OUT1 and OUT2 are turned OFF (for DC current output type, OUT1 low limit value) and the PV display flashes " - - - - - ".

However, for the manual control, the preset MV (manipulated variable) is outputted.

If the DC current or DC voltage input is disconnected, PV display flashes " - - - - - " for 4-20mA DC and 1-5V DC inputs, and " - - - - - " for 0-10mV DC, -10-10mV DC, 0-50mV DC, 0-100mV DC, 0-1V DC.

For 0-20mA DC, 0-5V DC and 0-10V DC input, the PV display indicates the value corresponding with 0mA or 0V input.

[Input abnormality indication]

Contents and Indication	Output status			
	OUT1		OUT2	
	Direct(Cooling) action	Reverse(Heating) action	Direct(Cooling) action	Reverse(Heating) action
Overscale Measured value has exceeded Indication range high limit value. "-----" flashes.	OFF(4mA) or OUT1 low limit value	OFF(4mA) or OUT1 low limit value	OFF or OUT2 low limit value	OFF or OUT2 low limit value
Underscale Measured value has dropped below Indication range low limit value. "-----" flashes.	OFF(4mA) or OUT1 low limit value	OFF(4mA) or OUT1 low limit value	OFF or OUT2 low limit value	OFF or OUT2 low limit value

For manual control, the preset MV (manipulated variable) is outputted.

[Indication range and Control range]

Thermocouple input: [Input range low limit value – 50°C(100°F)] to [Input range high limit value + 50°C(100°F)]

RTD input: [Input range low limit value -Input span x 1%] to [Input range high limit value + 50°C(100°F)]

DC current, voltage input:

[Scaling low limit value -Scaling span x 1%] to [Scaling high limit value +Scaling span x 10%]

[Warm-up indication]

After the power supply to the instrument is turned on, the PV display indicates the sensor input type, and SV display indicates input range high limit value (for thermocouple, RTD) or Scaling high limit value (for DC voltage, current input) for approximately 3 seconds.

[Console communication]

By connecting the USB communication cable (CMB-001) to the Console connector of the instrument, the following operations can be conducted from the external computer using the Console software SWS-AC001M.

Console communication and Serial communication (C, C5 option) cannot be used together.

- (1) Reading and setting of SV, PID and various set values
- (2) Reading of PV and action status,
- (3) Function change

Communication interface: C-MOS level

[PV color selection]

PV display color can be selected.

[Timer function (interlocked with the Event input)]

If Timer output which is interlocked with Event input is selected during Event output allocation, and if Timer Start/Stop is selected during Event input allocation, this function activates.

If Event input turns ON, timer counting starts, and Event output turns ON or OFF after delay timer time has passed.

If the timer function is allocated to the Event input which is interlocked with control, control turns ON while Event output is ON, and turns OFF if Event output is OFF.

[Bar graph]

The bar graph lights depending on the selection of either MV or DV.

With MV indication, if Heating/Cooling control output is added, bar graph indication for OUT1MV and OUT2MV differs.

Power consumption : Approx. 13VA

Ambient temperature : 0 to 50°C (32 to 122°F)

Ambient humidity : 35 to 85%RH (no condensation)

Weight : Approx. 460g

Accessories included

For the ACD-13A and ACR-13A:

Mounting brackets	: 1 set
Gasket (Front mounted to the unit)	: 1 piece
Instruction manual	: 1 copy

For the ACR-13A only:

Harness EVT5	: 1 piece [When Event output (A5 option) is added]
Harness W	: 1 piece [When Heater burnout alarm (W option) is added]
Harness W	: 2 pieces [When Heater burnout alarm (W3 option) is added]
Harness E	: 1 piece [When External setting input (EA□, EV□ option) is added]
Harness VT	: 1 piece [When Transmission output (TA1, TV1 option) is added]

Accessories sold separately:

Terminal cover

Heater burnout alarm 20A : CT (CTL-6S)

Heater burnout alarm 100A : CT (CTL-12-S36-10L1U)

USB communication cable (CMB-001)

13.2 Optional specifications

Event input (Option code: EI)

An Event input comprises events from EVI1 to EVI4.

Events selected from Event input allocation will be performed depending on the Input ON (Closed) or OFF (Open) status.

If Set value memory number function is selected:

2^0 , 2^1 , 2^2 and 2^3 will be allocated to Event input EVI1 to EVI4 respectively, and the Set value memory number (SV1 to SV15) will be determined by each value of EVI1 to EVI4.

The selected Set value memory number, the added value of $2^n + 1$, is indicated on the MEMO/STEP display.

Event output (Option code: A3)

EVT1 to EVT3 will be added using a common terminal.

Output will be turned ON or OFF depending on the conditions selected from Event output allocation.

Output: Relay contact, 1a

Control capacity, 3A 250V AC (Resistive load)

1A 250V AC (Inductive load, $\cos\phi=0.4$)

Electric life, 100,000 cycles

Event output (Option code: A5)

EVT4 to EVT5 can be added.

Output will be turned ON or OFF depending on the conditions selected from Event output allocation.

Output: Relay contact, 1a

Control capacity, 3A 250V AC (Resistive load)

1A 250V AC (Inductive load, $\cos\phi=0.4$)

Electric life, 100,000 cycles

Heater burnout alarm (including sensor burnout alarm) [Option code: W, W3]

Output will be turned ON or OFF depending on the conditions selected from Event output allocation.

This alarm is also activated when indication is overscale and underscale.

This option cannot be applied to DC current output type.

Rated current : One type can be selected from the following.

Single-phase 20A

Single-phase 100A

3-phase 20A

3-phase 100A

Single-phase: Detects burnout with CT1 input

3-phase: Detects burnout with CT1 and CT2 input

Setting range : 0.0 to 20.0A (for Heater rated current 20A) (Off when set to 0.0)

: 0.0 to 100.0A (for Heater rated current 100A) (Off when set to 0.0)

Setting accuracy: Within $\pm 5\%$ of the rated current

Action point : Heater burnout alarm value

Action : ON/OFF action

Output : Relay contact, 1a

Control capacity, 3A 250V AC (resistive load)

1A 250V AC (inductive load, $\cos\phi=0.4$)

Electric life, 100,000 cycles

Heating/Cooling control (Option code: D□)

OUT2 proportional band : 0.0 to 10.0 times OUT1 proportional band (ON/OFF action when set to 0.0)

OUT2 integral time : The same as that of OUT1.

OUT2 derivative time : The same as that of OUT1.

OUT2 proportional cycle : 1 to 120 seconds [Default: 30sec for Relay contact (DR), 3sec for Non-contact voltage (DS), Not available for DC current (DA)]

Overlap/Dead band setting range:

Thermocouple, RTD input: -200.0 to 200.0°C (°F)

DC current, voltage input : -2000 to 2000 (The placement of the decimal point follows the selection)

OUT2 ON/OFF action hysteresis:

Thermocouple, RTD input: 0.1 to 1000.0°C (°F) (Default: 1.0°C)

DC current, voltage input : 1 to 10000 (The placement of the decimal point follows the selection)

OUT2 high limit: 0 to 100% DA (DC current): -5 to 105% (Default: 100%)

OUT2 low limit : 0 to 100% DA (DC current): -5 to 105% (Default: 0%)

OUT2 action mode selection:

One cooling action can be selected from Air cooling (linear characteristic), Oil cooling (1.5th power of the linear characteristic) and Water cooling (2nd power of the linear characteristic) by keypad operation. (Default: Air cooling)

Cooling output (OUT2): DR; Relay contact, 1a

Control capacity: 3A 250V AC(resistive load)

Electric life, 100,000 cycles

DS; Non-contact voltage (for SSR drive)

12V DC ± 15%, Max. 40mA (short circuit protected)

DA; DC current

4 to 20mA DC (Resolution: 1/12000)

Load resistance: Max. 600Ω

Serial communication (Option code: C, C5)

This option and Console communication cannot be used together.

The following operations can be carried out from the external computer.

(1) Reading and setting of the SV (desired value), PID values and various set values

(2) Reading of the PV (process variable) and action status

(3) Function change

Cable length : Max.15m (C)

Max.1.2km (C5)

Cable resistance: Within 50Ω

(Terminator is not necessary or 120Ω or more on one side.)

Communication interface : EIA RS-232C (C)

EIA RS-485 (C5)

Communication method : Half-duplex communication

Synchronization method : Start-stop synchronization

Communication speed : 9600/19200/38400bps (Selectable by keypad)

(Default: 9600bps)

Data bit/Parity : 7 bits, 8bits/Even, Odd and No parity (Selectable by keypad)

(Default: 7 bits/Even parity)

Stop bit : 1, 2 (Selectable by keypad) (Default: 1)

Communication protocol : Shinko protocol/Modbus ASCII/Modbus RTU

(Selectable by keypad)

(Default: Shinko protocol)

Data format

Communication protocol	Shinko protocol	Modbus ASCII	Modbus RTU
Start bit	1		1
Data bit	7 or 8		8
Parity	Yes (Even, Odd) No parity		Yes (Even, Odd) No parity
Stop bit	1 or 2		1 or 2

Number of connectable units : 1 unit to 1 host computer (C)

Maximum 31 units to 1 host computer (C5)

Communication error detection: Parity, checksum (Shinko protocol), LRC (Modbus ASCII), CRC-16 (Modbus RTU)

Digital external setting: Receives digital set values from Shinko programmable controllers (PC-900, PCD-33A with SVTC option).

If data from the PC-900 or PCD-33A is higher than the SV high limit or lower than SV low limit value, this instrument ignores the value, and controls at SV high limit or SV low limit value.
SV adds digital set value to SVTC bias value.

External setting input (option code: EA□, EV□)

SV adds external analog signal to remote bias value.

Setting signal : DC current; 4 to 20mA DC [Option code: EA1]
0 to 20mA DC [Option code: EA2]
DC voltage; 0 to 1V DC [Option code: EV1]
1 to 5V DC [Option code: EV2]

Allowable input : EA□; 50mA DC or less
EV1; 5V DC or less
EV2; 10V DC or less

Input impedance : EA□; 50Ω
EV□; 100kΩ

Input sampling period : 0.25sec

Transmission output (option code: TA1, TV1)

Converting the value (PV, SV, MV or DV transmission) to analog signal every 0.125 seconds, outputs the value in current or voltage. (Default: PV transmission)

Outputs Transmission output low limit value (4mA DC or 0V DC) if Transmission output high limit and low limit value are the same.

Resolution : 1/12000

Output : 4 to 20mA DC (load resistance, max. 500Ω)
0 to 1V DC (load resistance, min. 100kΩ)

Output accuracy: Within ±0.3% of Transmission output span

Insulated power output (option code: P)

Output voltage : 24±3V DC (when load current is 30mA DC)

Ripple voltage : Within 200mV DC (when load current is 30mA DC)

Max. load current: 30mA DC

14. Troubleshooting

If any malfunctions occur, refer to the following items after checking the power supply to the controller.

14.1 Indication

Problem	Presumed cause and solution
[OFF], nothing or PV is indicated on the PV display.	<ul style="list-style-type: none"> Control output OFF function is working. Press the $\frac{\text{RUN}}{\text{STOP}}$ key for approx. 1sec to release the function.
[-----] is flashing on the PV display.	<ul style="list-style-type: none"> Burnout of thermocouple, RTD or disconnection of DC voltage (0-10mV DC, -10-10mV DC, 0-50mV DC, 0-100mV DC, 0-1V DC) Change each sensor. <p>How to check whether the sensor is burnt out</p> <p>[Thermocouple] If the input terminals of the instrument are shorted, and if a value around room temperature is indicated, the instrument is likely to be operating normally, however, the sensor may be burnt out.</p> <p>[RTD] If approx. 100Ω of resistance is connected to the input terminals between A-B of the instrument and between B-B is shorted, and if a value around 0°C (32°F) is indicated, the instrument is likely to be operating normally, however, the sensor may be burnt out.</p> <p>[DC voltage (0-10mV DC, -10-10mV DC, 0-50mV DC, 0-100mV DC, 0-1VDC)] If the input terminals of the instrument are shorted, and if a scaling low limit value is indicated, the instrument is likely to be operating normally, however, the signal wire may be disconnected.</p> <ul style="list-style-type: none"> Check whether the input terminals of thermocouple, RTD or DC voltage (0-10mV DC, -10-10mV DC, 0-50mV DC, 0-100mV DC, 0-1V DC) are securely mounted to the instrument input terminal. Connect the sensor terminals to the instrument input terminals securely.
[- - - - -] is flashing on the PV display.	<ul style="list-style-type: none"> Check whether input signal wire for DC voltage (1 to 5V DC) or DC current (4 to 20mA DC) is disconnected. <p>How to check whether the input signal wire is disconnected</p> <p>[DC voltage (1 to 5V DC)] If the input to the input terminals of the instrument is 1V DC and if a scaling low limit value is indicated, the instrument is likely to be operating normally, however, the signal wire may be disconnected.</p> <p>[DC current (4 to 20mA DC)] If the input to the input terminals of the instrument is 4mA DC and if a scaling low limit value is indicated, the instrument is likely to be operating normally, however, the signal wire may be disconnected.</p> <ul style="list-style-type: none"> Check whether input signal wire for DC voltage (1 to 5V DC) or DC current (4 to 20mA DC) is securely connected to the instrument input terminals.

	<ul style="list-style-type: none"> • Check if polarity of thermocouple or compensating lead wire is correct. • Check whether codes (A, B, B) of RTD agree with the instrument terminals.
The PV display keeps indicating the value which was set during Scaling low limit setting.	<ul style="list-style-type: none"> • Check whether the input signal wire for DC voltage (0 to 5V DC, 0 to 10V DC) and DC current (0 to 20mA DC) is disconnected. <p>How to check whether the input signal wire is disconnected [DC voltage (0 to 5V DC, 0 to 10V DC)] If the input to the input terminals of the instrument is 0V DC and if a scaling low limit value is indicated, the instrument is likely to be operating normally, however, the signal wire may be disconnected.</p> <p>[DC current (0 to 20mA DC)] If the input to the input terminals of the instrument is 0mA DC and if a scaling low limit value is indicated, the instrument is likely to be operating normally, however, the signal wire may be disconnected.</p> <ul style="list-style-type: none"> • Check whether the input lead wire terminals for DC voltage (0 to 5V DC, 0 to 10V DC) or DC current (0 to 20mA DC) are securely mounted to the instrument input terminals.
The indication of PV display is abnormal or unstable.	<ul style="list-style-type: none"> • Check whether sensor input or temperature unit (°C or °F) is correct. Select the sensor input and temperature unit (°C or °F) properly. • Sensor correcting value is unsuitable. Set it to a suitable value. • Check whether the specification of the sensor is correct. • AC leaks into the sensor circuit. Use an ungrounded type sensor. • There may be equipment that interferes with or makes noise near the controller. Keep equipment that interferes with or makes noise away from the controller.
[Err] is indicated on the PV display.	<ul style="list-style-type: none"> • Internal memory is defective. Contact our agency or us.

14.2 Key operation

Problem	Presumed cause and solution
<ul style="list-style-type: none"> • Unable to set the SV, P, I, D, Event alarm value, etc. • The values do not change by the \triangle, ∇ keys. 	<ul style="list-style-type: none"> • Set value lock (Lock 1 to Lock 4) is selected. Release the lock during the "Set value lock selection". • Auto-tuning or auto-reset is performing. In the case of auto-tuning, cancel auto-tuning. It takes approximately 4 minutes until auto-reset is finished.
Setting items of each Event output are not indicated.	Check if the desired action has been selected during Event output allocation.

14.3 Control

Problem	Presumed cause and solution
Temperature does not rise.	<ul style="list-style-type: none">• Sensor is out of order. Replace the sensor.• Check whether the Sensor or control output terminals are securely mounted to the instrument input terminals. Ensure that the sensor or control output terminals are mounted to the instrument input terminals securely.• Check whether the wiring of sensor or control output terminals is correct.
The control output remains in an ON status.	<ul style="list-style-type: none">• OUT1 or OUT2 low limit value is set to 100% or higher. Set it to a suitable value.
The control output remains in an OFF status.	<ul style="list-style-type: none">• OUT1 or OUT2 high limit value is set to 0% or less. Set it to a suitable value.

For all other malfunctions, please contact our main office or dealers.

15. Character tables





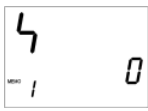

The PV display indicates setting characters, and the SV display indicates default value.

[Simplified setting]

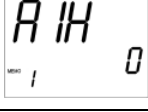
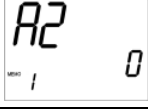
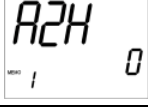
SV setting mode

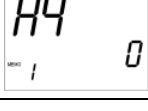
Character	Setting item	Data
	SV Scaling low limit to Scaling high limit	

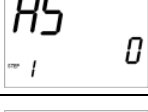
Event setting mode

Character	Setting item	Data
	EVT1 alarm value Setting range: Refer to (Table 15-1) on p.101.	
	EVT1 high limit alarm value Setting range: Refer to (Table 15-1) on p.101.	
	EVT2 alarm value Setting range: Refer to (Table 15-1) on p.101.	
	EVT2 high limit alarm value Setting range: Refer to (Table 15-1) on p.101.	
	EVT3 alarm value Setting range: Refer to (Table 15-1) on p.101.	
	EVT3 high limit alarm value Setting range: Refer to (Table 15-1) on p.101	
	EVT4 alarm value Setting range: Refer to (Table 15-1) on p.101.	
	EVT4 high limit alarm value Setting range: Refer to (Table 15-1) on p.101.	
	EVT5 alarm value Setting range: Refer to (Table 15-1) on p.101.	
	EVT5 high limit alarm value Setting range: Refer to (Table 15-1) on p.101.	







(Table 15-1)

Alarm type	Setting range
High limit alarm (Deviation setting)	-(Input span) to Input span ^{°C(°F)} *1
Low limit alarm (Deviation setting)	-(Input span) to Input span ^{°C(°F)} *1
High/Low limits alarm (Deviation setting)	0 to Input span ^{°C(°F)} *1
High/Low limits independent (Deviation setting)	0 to Input span ^{°C(°F)} *1
High/Low limit range alarm (Deviation setting)	0 to Input span ^{°C(°F)} *1
High/Low limit range independent (Deviation setting)	0 to Input span ^{°C(°F)} *1
Process high alarm	Input range low limit to Input range high limit*2
Process low alarm	Input range low limit to Input range high limit*2
High limit alarm with standby (Deviation setting)	-(Input span) to Input span ^{°C(°F)} *1
Low limit alarm with standby (Deviation setting)	-(Input span) to Input span ^{°C(°F)} *1
High/Low limits with standby (Deviation setting)	0 to Input span ^{°C(°F)} *1
High/Low limits with standby independent (Deviation setting)	0 to Input span ^{°C(°F)} *1

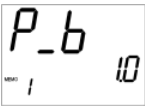
*1: For DC voltage, current input, the input span is the same as the scaling span.



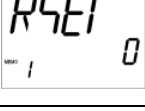





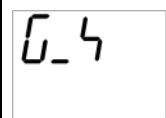
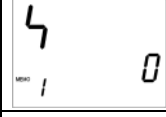

*2: For DC voltage, current input, input range low (or high) limit value is the same as scaling low (or high) limit value.

PID setting mode



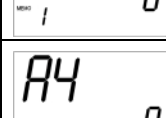
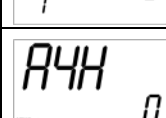



Character	Setting item	Data
	OUT1 proportional band 0 to Input span ^{°C(°F)} DC voltage, current input: 0.0 to 1000.0%	
	OUT2 proportional band 0.0 to 10.0 times (Multiplying factor to OUT1 proportional band)	
	Integral time 0 to 3600sec	
	Derivative time 0 to 1800sec	
	ARW 0 to 100%	
	Manual reset ±10000 DC voltage, current input: The placement of the decimal point follows the selection.	
	OUT1 rate-of-change 0 to 100%/sec	

[Group selection]

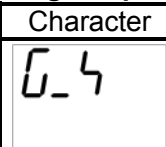
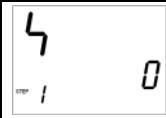
SV, Event group (for Fixed value control)

Character	Setting item	Data
	SV, Event group	
	SV1 Scaling low limit to Scaling high limit	
	EVT1 alarm value Setting range: Refer to (Table 15-1) on p.101.	
	EVT1 high limit alarm value Setting range: Refer to (Table 15-1) on p.101.	
	EVT2 alarm value Setting range: Refer to (Table 15-1) on p.101.	
	EVT2 high limit alarm value Setting range: Refer to (Table 15-1) on p.101.	
	EVT3 alarm value Setting range: Refer to (Table 15-1) on p.101.	
	EVT3 high limit alarm value Setting range: Refer to (Table 15-1) on p.101.	
	EVT4 alarm value Setting range: Refer to (Table 15-1) on p.101.	
	EVT4 high limit alarm value Setting range: Refer to (Table 15-1) on p.101.	
	EVT5 alarm value Setting range: Refer to (Table 15-1) on p.101.	
	EVT5 high limit alarm value Setting range: Refer to (Table 15-1) on p.101.	

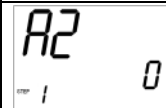
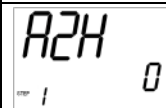
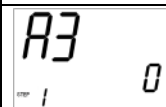
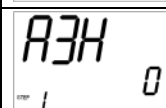
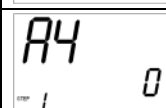
Program pattern group (for Program control)

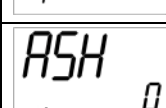
Character	Setting item	Data
	Program pattern group	
	Step 1 SV Scaling low limit to Scaling high limit value	
	Step 1 time 00:00 to 99:59	
	Step 1 Wait value 0 to Converted value of 20% of the input span	
	Step 1 EVT1 alarm value Setting range: Refer to (Table 15-1) on p.101.	
	Step 1 EVT1 high limit alarm value Setting range: Refer to (Table 15-1) on p.101.	
	Step 1 EVT2 alarm value Setting range: Refer to (Table 15-1) on p.101.	
	Step 1 EVT2 high limit alarm value Setting range: Refer to (Table 15-1) on p.101.	
	Step 1 EVT3 alarm value Setting range: Refer to (Table 15-1) on p.101.	
	Step 1 EVT3 high limit alarm value Setting range: Refer to (Table 15-1) on p.101.	
	Step 1 EVT4 alarm value Setting range: Refer to (Table 15-1) on p.101.	
	Step 1 EVT4 high limit alarm value Setting range: Refer to (Table 15-1) on p.101.	
	Step 1 EVT5 alarm value Setting range: Refer to (Table 15-1) on p.101.	
	Step 1 EVT5 high limit alarm value Setting range: Refer to (Table 15-1) on p.101.	





	Step 2 SV	
	Step 2 time	
	Step 2 Wait value	
	Step 2 EVT1 alarm value	
	Step 2 EVT1 high limit alarm value	
	Step 2 EVT2 alarm value	
	Step 2 EVT2 high limit alarm value	
	Step 2 EVT3 alarm value	
	Step 2 EVT3 high limit alarm value	
	Step 2 EVT4 alarm value	
	Step 2 EVT4 high limit alarm value	
	Step 2 EVT5 alarm value	
	Step 2 EVT5 high limit alarm value	
	Step 3 SV	
	Step 3 time	
	Step 3 Wait value	
	Step 3 EVT1 alarm value	
	Step 3 EVT1 high limit alarm value	
	Step 3 EVT2 alarm value	
	Step 3 EVT2 high limit alarm value	
	Step 3 EVT3 alarm value	
	Step 3 EVT3 high limit alarm value	
	Step 3 EVT4 alarm value	
	Step 3 EVT4 high limit alarm value	
	Step 3 EVT5 alarm value	
	Step 3 EVT5 high limit alarm value	
	Step 4 SV	
	Step 4 time	
	Step 4 Wait value	
	Step 4 EVT1 alarm value	
	Step 4 EVT1 high limit alarm value	
	Step 4 EVT2 alarm value	
	Step 4 EVT2 high limit alarm value	
	Step 4 EVT3 alarm value	
	Step 4 EVT3 high limit alarm value	
	Step 4 EVT4 alarm value	
	Step 4 EVT4 high limit alarm value	
	Step 4 EVT5 alarm value	
	Step 4 EVT5 high limit alarm value	
	Step 5 SV	
	Step 5 time	
	Step 5 Wait value	
	Step 5 EVT1 alarm value	
	Step 5 EVT1 high limit alarm value	
	Step 5 EVT2 alarm value	
	Step 5 EVT2 high limit alarm value	
	Step 5 EVT3 alarm value	
	Step 5 EVT3 high limit alarm value	
	Step 5 EVT4 alarm value	
	Step 5 EVT4 high limit alarm value	

	Step 5 EVT5 alarm value	
	Step 5 EVT5 high limit alarm value	
	Step 6 SV	
	Step 6 time	
	Step 6 Wait value	
	Step 6 EVT1 alarm value	
	Step 6 EVT1 high limit alarm value	
	Step 6 EVT2 alarm value	
	Step 6 EVT2 high limit alarm value	
	Step 6 EVT3 alarm value	
	Step 6 EVT3 high limit alarm value	
	Step 6 EVT4 alarm value	
	Step 6 EVT4 high limit alarm value	
	Step 6 EVT5 alarm value	
	Step 6 EVT5 high limit alarm value	
	Step 7 SV	
	Step 7 time	
	Step 7 Wait value	
	Step 7 EVT1 alarm value	
	Step 7 EVT1 high limit alarm value	
	Step 7 EVT2 alarm value	
	Step 7 EVT2 high limit alarm value	
	Step 7 EVT3 alarm value	
	Step 7 EVT3 high limit alarm value	
	Step 7 EVT4 alarm value	
	Step 7 EVT4 high limit alarm value	
	Step 7 EVT5 alarm value	
	Step 7 EVT5 high limit alarm value	
	Step 8 SV	
	Step 8 time	
	Step 8 Wait value	
	Step 8 EVT1 alarm value	
	Step 8 EVT1 high limit alarm value	
	Step 8 EVT2 alarm value	
	Step 8 EVT2 high limit alarm value	
	Step 8 EVT3 alarm value	
	Step 8 EVT3 high limit alarm value	
	Step 8 EVT4 alarm value	
	Step 8 EVT4 high limit alarm value	
	Step 8 EVT5 alarm value	
	Step 8 EVT5 high limit alarm value	
	Step 9 SV	
	Step 9 time	
	Step 9 Wait value	
	Step 9 EVT1 alarm value	
	Step 9 EVT1 high limit alarm value	
	Step 9 EVT2 alarm value	
	Step 9 EVT2 high limit alarm value	
	Step 9 EVT3 alarm value	
	Step 9 EVT3 high limit alarm value	

	Step 9 EVT4 alarm value	
	Step 9 EVT4 high limit alarm value	
	Step 9 EVT5 alarm value	
	Step 9 EVT5 high limit alarm value	
	Step 10 SV	
	Step 10 time	
	Step 10 Wait value	
	Step 10 EVT1 alarm value	
	Step 10 EVT1 high limit alarm value	
	Step 10 EVT2 alarm value	
	Step 10 EVT2 high limit alarm value	
	Step 10 EVT3 alarm value	
	Step 10 EVT3 high limit alarm value	
	Step 10 EVT4 alarm value	
	Step 10 EVT4 high limit alarm value	
	Step 10 EVT5 alarm value	
	Step 10 EVT5 high limit alarm value	
	Step 11 SV	
	Step 11 time	
	Step 11 Wait value	
	Step 11 EVT1 alarm value	
	Step 11 EVT1 high limit alarm value	
	Step 11 EVT2 alarm value	
	Step 11 EVT2 high limit alarm value	
	Step 11 EVT3 alarm value	
	Step 11 EVT3 high limit alarm value	
	Step 11 EVT4 alarm value	
	Step 11 EVT4 high limit alarm value	
	Step 11 EVT5 alarm value	
	Step 11 EVT5 high limit alarm value	
	Step 12 SV	
	Step 12 time	
	Step 12 Wait value	
	Step 12 EVT1 alarm value	
	Step 12 EVT1 high limit alarm value	
	Step 12 EVT2 alarm value	
	Step 12 EVT2 high limit value	
	Step 12 EVT3 alarm value	
	Step 12 EVT3 high limit alarm value	
	Step 12 EVT4 alarm value	
	Step 12 EVT4 high limit alarm value	
	Step 12 EVT5 alarm value	
	Step 12 EVT5 high limit alarm value	
	Step 13 SV	
	Step 13 time	
	Step 13 Wait value	
	Step 13 EVT1 alarm value	
	Step 13 EVT1 high limit alarm value	
	Step 13 EVT2 alarm value	
	Step 13 EVT2 high limit alarm value	

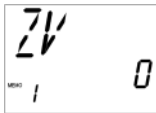
	Step 13 EVT3 alarm value	
	Step 13 EVT3 high limit alarm value	
	Step 13 EVT4 alarm value	
	Step 13 EVT4 high limit alarm value	
	Step 13 EVT5 alarm value	
	Step 13 EVT5 high limit alarm value	
	Step 14 SV	
	Step 14 time	
	Step 14 Wait value	
	Step 14 EVT1 alarm value	
	Step 14 EVT1 high limit alarm value	
	Step 14 EVT2 alarm value	
	Step 14 EVT2 high limit alarm value	
	Step 14 EVT3 alarm value	
	Step 14 EVT3 high limit alarm value	
	Step 14 EVT4 alarm value	
	Step 14 EVT4 high limit alarm value	
	Step 14 EVT5 alarm value	
	Step 14 EVT5 high limit alarm value	
	Step 15 SV	
	Step 15 time	
	Step 15 Wait value	
	Step 15 EVT1 alarm value	
	Step 15 EVT1 high limit alarm value	
	Step 15 EVT2 alarm value	
	Step 15 EVT2 high limit alarm value	
	Step 15 EVT3 alarm value	
	Step 15 EVT3 high limit alarm value	
	Step 15 EVT4 alarm value	
	Step 15 EVT4 high limit alarm value	
	Step 15 EVT5 alarm value	
	Step 15 EVT5 high limit alarm value	

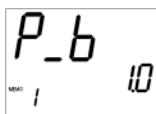
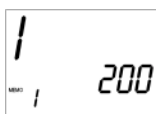
PID group

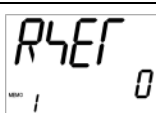
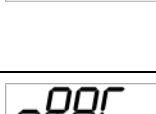
Character	Setting item	Data
	PID group	
	PID zone value 1 Scaling low limit to Scaling high limit	
	OUT1 proportional band 1 0 to Input span°C(°F) DC voltage, current input: 0.0 to 1000.0%	
	OUT2 proportional band 1 0.0 to 10.0 times (Multiplying factor to OUT1 proportional band)	
	Integral time 1 0 to 3600sec	
	Derivative time 1 0 to 1800sec	
	ARW 1 0 to 100%	
	Manual reset 1 ±10000 DC voltage, current input: (The placement of the decimal point follows the selection.)	
	OUT1 rate-of-change 1 0 to 100%/sec	
	PID zone value 2	
	OUT1 proportional band 2	
	OUT2 proportional band 2	
	Integral time 2	
	Derivative time 2	
	ARW 2	
	Manual reset 2	
	OUT1 rate-of-change 2	
	PID zone value 3	
	OUT1 proportional band 3	
	OUT2 proportional band 3	

	Integral time 3	
	Derivative time 3	
	ARW 3	
	Manual reset 3	
	OUT1 rate-of-change 3	
	PID zone value 4	
	OUT1 proportional band 4	
	OUT2 proportional band 4	
	Integral time 4	
	Derivative time 4	
	ARW 4	
	Manual reset 4	
	OUT1 rate-of-change 4	
	PID zone value 5	
	OUT1 proportional band 5	
	OUT2 proportional band 5	
	Integral time 5	
	Derivative time 5	
	ARW 5	
	Manual reset 5	
	OUT1 rate-of-change 5	

AT group





Character	Setting item	Data
G_AF	AT group	
AF -----	AT/Auto-reset ----- : AT/ Auto-reset Cancel AF□□□ / R4ET□ : AT/ Auto-reset Perform	
AF_b 20	AT bias 0 to 50°C (0 to 100°F) With a decimal point: 0.0 to 50.0°C (0.0 to 100.0°F)	

Engineering group

Character	Setting item	Data
G_ENG	Engineering group	

Input group

Character	Setting item	Data
E_I NP	Input group	
4EN4 K C	Input type	
K000C	K	-200 to 1370 °C
K00.C	K	-200.0 to 400.0 °C
J000C	J	-200 to 1000 °C
R000C	R	0 to 1760 °C
4000C	S	0 to 1760 °C
b000C	B	0 to 1820 °C
E000C	E	-200 to 800 °C
T00.C	T	-200.0 to 400.0 °C
N000C	N	-200 to 1300 °C
PL20C	PL-II	0 to 1390 °C
c000C	C(W/Re5-26)	0 to 2315 °C
Pt0.C	Pt100	-200.0 to 850.0 °C
JPt.C	JPt100	-200.0 to 500.0 °C
Pt00C	Pt100	-200 to 850 °C
JPt0C	JPt100	-200 to 500 °C
Pt1.C	Pt100	-100.0 to 100.0 °C
Pt5.C	Pt100	-100.0 to 500.0 °C
K000F	K	-328 to 2498 °F
K00.F	K	-328.0 to 752.0 °F
J000F	J	-328 to 1832 °F
R000F	R	32 to 3200 °F
4000F	S	32 to 3200 °F
b000F	B	32 to 3308 °F
E000F	E	-328 to 1472 °F
T00.F	T	-328.0 to 752.0 °F
N000F	N	-328 to 2372 °F
PL20F	PL-II	32 to 2534 °F
c000F	C(W/Re5-26)	32 to 4199 °F
Pt0.F	Pt100	-328.0 to 1562.0 °F
JPt.F	JPt100	-328.0 to 932.0 °F
Pt00F	Pt100	-328 to 1562 °F
JPt0F	JPt100	-328 to 932 °F
Pt2.F	Pt100	-148.0 to 212.0 °F
Pt9.F	Pt100	-148.0 to 932.0 °F

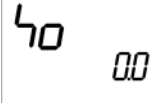
	<table border="1"> <tbody> <tr> <td>420mA</td> <td>4 to 20mA DC</td> <td>-2000 to 10000</td> </tr> <tr> <td>020mA</td> <td>0 to 20mA DC</td> <td>-2000 to 10000</td> </tr> <tr> <td>□ 10mV</td> <td>0 to 10mV DC</td> <td>-2000 to 10000</td> </tr> <tr> <td>- 10mV</td> <td>-10 to 10mV DC</td> <td>-2000 to 10000</td> </tr> <tr> <td>□ 50mV</td> <td>0 to 50mV DC</td> <td>-2000 to 10000</td> </tr> <tr> <td>100mV</td> <td>0 to 100mV DC</td> <td>-2000 to 10000</td> </tr> <tr> <td>00 1V</td> <td>0 to 1V DC</td> <td>-2000 to 10000</td> </tr> <tr> <td>005V</td> <td>0 to 5V DC</td> <td>-2000 to 10000</td> </tr> <tr> <td>105V</td> <td>1 to 5V DC</td> <td>-2000 to 10000</td> </tr> <tr> <td>0 10V</td> <td>0 to 10V DC</td> <td>-2000 to 10000</td> </tr> </tbody> </table>	420mA	4 to 20mA DC	-2000 to 10000	020mA	0 to 20mA DC	-2000 to 10000	□ 10mV	0 to 10mV DC	-2000 to 10000	- 10mV	-10 to 10mV DC	-2000 to 10000	□ 50mV	0 to 50mV DC	-2000 to 10000	100mV	0 to 100mV DC	-2000 to 10000	00 1V	0 to 1V DC	-2000 to 10000	005V	0 to 5V DC	-2000 to 10000	105V	1 to 5V DC	-2000 to 10000	0 10V	0 to 10V DC	-2000 to 10000	
420mA	4 to 20mA DC	-2000 to 10000																														
020mA	0 to 20mA DC	-2000 to 10000																														
□ 10mV	0 to 10mV DC	-2000 to 10000																														
- 10mV	-10 to 10mV DC	-2000 to 10000																														
□ 50mV	0 to 50mV DC	-2000 to 10000																														
100mV	0 to 100mV DC	-2000 to 10000																														
00 1V	0 to 1V DC	-2000 to 10000																														
005V	0 to 5V DC	-2000 to 10000																														
105V	1 to 5V DC	-2000 to 10000																														
0 10V	0 to 10V DC	-2000 to 10000																														
	<p>Scaling high limit Scaling low limit to Input range high limit DC voltage, current input: -2000 to 10000 (The placement of the decimal point follows the selection.)</p>																															
	<p>Scaling low limit Input range low limit to Scaling high limit DC voltage, current input: -2000 to 10000 (The placement of the decimal point follows the selection.)</p>																															
	<p>Decimal point place □□□□ : No decimal point □□□□ : 1 digit after decimal point □□□□ : 2 digits after decimal point □□□□ : 3 digits after decimal point □□□□ : 4 digits after decimal point</p>																															
	<p>PV filter time constant 0.0 to 100.0sec</p>																															
	<p>Sensor correction -200.0 to 200.0°C(°F) DC voltage, current input: -2000 to 2000 (The placement of the decimal point follows the selection.)</p>																															

Output group

Character	Setting item	Data
<i>E_oUr</i>	Output group	
<i>c</i> 30	OUT1 proportional cycle 1 to 120sec	
<i>c-b</i> 30	OUT2 proportional cycle 1 to 120sec	
<i>oLH</i> 100	OUT1 high limit OUT1 low limit to 100% (DC current output: OUT1 low limit to 105%)	
<i>oLL</i> 0	OUT1 low limit 0% to OUT1 high limit (DC current output: -5% to OUT1 high limit)	
<i>HY4</i> 10	OUT1 ON/OFF action hysteresis 0.1 to 1000.0°C(°F) DC voltage, current input: 1 to 10000 (The placement of the decimal point follows the selection.)	
<i>cAcF</i> <i>Ai R</i>	OUT2 action mode <i>Ai R</i> □ : Air cooling (linear characteristic) <i>oi L</i> □ : Oil cooling(1.5th power of the linear characteristic) <i>WAF</i> □ : Water cooling (2nd power of the linear characteristic)	
<i>oLHb</i> 100	OUT2 high limit OUT2 low limit to 100% (DC current output: OUT2 low limit to 105%)	
<i>oLLb</i> 0	OUT2 low limit 0% to OUT2 high limit (DC current output: -5% to OUT2 high limit)	
<i>db</i> 00	Overlap/Dead band -200.0 to 200.0°C(°F) DC voltage, current input: -2000 to 2000 (The placement of the decimal point follows the selection.)	
<i>HY4b</i> 10	OUT2 ON/OFF action hysteresis 0.1 to 1000.0°C(°F) DC voltage, current input: 1 to 10000 (The placement of the decimal point follows the selection.)	
<i>CONF</i> <i>HEAF</i>	Direct/Reverse action <i>HEAF</i> □ : Reverse (Heating) action <i>c o o L</i> □ : Direct (Cooling) action	

PR471 00	OUT1 preset output 0.0 to 100.0% (DC current output: -5.0 to 105.0%)	
PR472 00	OUT2 preset output 0.0 to 100.0% (DC current output: -5.0 to 105.0%)	

Event input group







Character	Setting item	Data
E_EVI	Event input group	
EVI1 000	Event input EVI1 allocation Refer to the Event input allocation table.	
EVI2 000	Event input EVI2 allocation Refer to the Event input allocation table.	
EVI3 000	Event input EVI3 allocation Refer to the Event input allocation table.	
EVI4 000	Event input EVI4 allocation Refer to the Event input allocation table.	

Event input allocation table

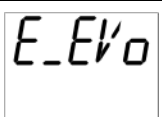
Selected value	Event input function	Input ON (Closed)	Input OFF (Open)	Remarks
000	No event			
001	Set value memory	2 ⁿ	1	n=0 to 3
002	Control ON/OFF	Control ON	Control OFF	OUT/OFF function
003	Direct/Reverse action	Direct action	Reverse action	Always effective
004	Timer Start/Stop	Start	Stop	
005	PV display; PV holding	Holding	Not holding	Ineffective when controlling
006	PV display; PV peak value holding	Holding	Not holding	Ineffective when controlling

Selected value	Event input function	Input ON (Closed)	Input OFF (Open)	Remarks
007	Preset output	Preset output	Standard control	In case of sensor burnout, the unit maintains control with the preset output MV.
008	Auto/Manual control	Manual control	Automatic control	
009	Remote/Local	Remote	Local	Effective only when EA□ or EV□ option is added
010	Program mode; RUN/STOP	RUN	STOP	Level action when power-on
011	Program mode; Holding/Not holding	Holding	Not holding	Level action when power-on
012	Program mode; Advance function	Advance	Standard control	Level action when power-on
013	Integral action holding	Integral action Holding	Standard integral action	Control continues with the integral value being held.

Event output group



Character	Setting item	Data
	Event output group	
	Event output EVT1 allocation Refer to Event output allocation table.	
	Event output EVT2 allocation Refer to Event output allocation table.	
	Event output EVT3 allocation Refer to Event output allocation table.	
	Event output EVT4 allocation Refer to Event output allocation table.	
	Event output EVT5 allocation Refer to Event output allocation table.	

Event output allocation table

Selected value	Event output function	Proceeding to the lower level with the MODE key	Remarks
000	No event		
001	Alarm output; High limit alarm	Alarm hysteresis ↓ MODE Alarm action delayed timer ↓ MODE Alarm Energized/De-energized	
002	Alarm output; Low limit alarm	The same as the High limit alarm	
003	Alarm output; High/Low limits	The same as the High limit alarm	
004	Alarm output; High/Low limits independent	The same as the High limit alarm	
005	Alarm output; High/Low limit range	The same as the High limit alarm	
006	Alarm output; High/Low limit range independent	The same as the High limit alarm	
007	Alarm output; Process high alarm	The same as the High limit alarm	
008	Alarm output; Process low alarm	The same as the High limit alarm	
009	Alarm output; High limit with standby	The same as the High limit alarm	
010	Alarm output; Low limit with standby	The same as the High limit alarm	
011	Alarm output; High/Low limits with standby	The same as the High limit alarm	
012	Alarm output; High/Low limits with standby independent	The same as the High limit alarm	
013	Timer output interlocked with "Timer Start/Stop" in Event input allocation.	Timer output delay action ↓ MODE Timer output time unit ↓ MODE OFF delay timer time ↓ MODE ON delay timer time	Select "Timer Start/Stop" in Event input allocation.
014	Timer output interlocked with "Timer Start/Stop" in Event input allocation. Control ON during timer operation. Control OFF after time is up.	The same as the above	The same as the above



Selected value	Event output function	Proceeding to the lower level with the MODE key	Remarks
015	Heater burnout alarm output	Heater rated current ↓ MODE Heater burnout alarm 1 value ↓ MODE Heater burnout alarm 2 value	Rated current 20A or 100A. Settable within the rated current.
016	Loop break alarm output	Loop break alarm time ↓ MODE Loop break alarm span	
017	Time signal output	Time signal output step ↓ MODE Time signal OFF time ↓ MODE Time signal ON time	Time signal output is turned off when the performing step is complete.
018	Output during AT		Output during AT
019	Pattern end output		Program control

Alarm output setting items (when alarm output is selected during Event output allocation)

Character	Setting item	Data
	Alarm hysteresis 0.1 to 1000.0°C(°F) DC voltage, current input: 1 to 10000 (The placement of the decimal point follows the selection.)	
	Alarm action delayed timer 0 to 10000sec	
	Alarm Energized/De-energized NoML : Energized REV4 : De-energized	

If “001 (Alarm output; High limit alarm) to 012 (Alarm output; High/Low limits with standby independent)” is selected during Event output EVT2 to EVT5 allocation, their setting characters will be *R2xxx* to *R5xxx*.

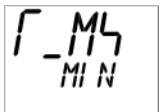
Timer output setting items (when timer output is selected during Event output allocation)

Character	Setting item	Data
	Timer output delay action oN : ON delay timer oFF : OFF delay timer oNoFF : ON/OFF delay timer	
	Timer output time unit MI N : Minute 4Ec : Second	
	OFF delay timer time 0 to 10000 (Time unit follows the selection from the Timer output time unit selection.)	
	ON delay timer time 0 to 10000 (Time unit follows the selection from the Timer output time unit selection.)	

Heater burnout alarm output setting items (when Heater burnout alarm is selected during Event output allocation)

Character	Setting item	Data
H_4L 200A	Heater rated current □200A : 20.0A 1000A : 100.0A	
H 00	Heater burnout alarm 1 value Rated current 20.0A : 0.0 to 20.0A, 100.0A : 0.0 to 100.0A	
H2 00	Heater burnout alarm 2 value Rated current 20.0A : 0.0 to 20.0A, 100.0A : 0.0 to 100.0A	

Loop break alarm setting items (when Loop break alarm is selected during Event output allocation)

Character	Setting item	Data
LP_Γ 0	Loop break alarm time 0 to 200min	
LP_H 0	Loop break alarm span 0 to 150°C(°F) or 0.0 to 150.0°C(°F) DC voltage and current input: 0 to 1500 (The placement of the decimal point follows the selection.)	

Time signal output setting items (when Time signal output is selected during Event output allocation)

Character	Setting item	Data
Γ4_No, 1	Time signal output step 1 to 15	
Γ4_of 0000	Time signal output OFF time 00:00 to 99:59 (Time unit follows the selection from the Step time unit selection in the Program group.)	
Γ4_on 0000	Time signal output ON time 00:00 to 99:59 (Time unit follows the selection from the Step time unit selection in the Program group.)	

Program group

Character	Setting item	Data
E_PRO	Program group	
PRGMd FI x	Fixed value control/Program control FI x: Fixed value control PRGM: Program control	
M_4 MIN	Step time unit MIN: Hour:Minute 4EC: Minute:Second	
PREF 4FoP	Power restore action 4FoP: Stops (standby) after power restoration cONF: Continues after power restoration HoLd: Suspended (On hold) after power restoration	
4_4V 0	Program start temperature Scaling low limit to Scaling high limit value	

Communication group





Character	Setting item	Data
E_COM	Communication group	
CM4L NoML	Communication protocol NoML: Shinko protocol ModAS: Modbus ASCII mode ModRT: Modbus RTU mode	
CMNO 0	Instrument number 0 to 95	
CM4P 96	Communication speed 96: 9600bps 192: 19200bps 384: 38400bps	
CMFF 7EVN	Data bit/Parity 8NoP: 8 bits/No parity 7NoP: 7 bits/No parity 8EVN: 8 bits/Even parity 7EVN: 7 bits/Even parity 8oDD: 8 bits/Odd parity 7oDD: 7 bits/Odd parity	

	Stop bit : 1 : 2	
	SVTC bias Converted value of $\pm 20\%$ of the input span DC voltage, current input: $\pm 20\%$ of the scaling span (The placement of the decimal point follows the selection.)	





External setting group





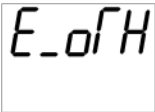



Character	Setting item	Data
	External setting group	
	Remote/Local <i>LocAL</i> : Local <i>REMoF</i> : Remote	
	External setting input high limit External setting input low limit to Input range high limit	
	External setting input low limit Input range low limit to External setting input high limit	
	Remote bias Converted value of $\pm 20\%$ of the input span DC voltage, current input: $\pm 20\%$ of the scaling span (The placement of the decimal point follows the selection.)	

Transmission output group

Character	Setting item	Data
	Transmission output group	
	Transmission output PV <input type="checkbox"/> : PV (process variable) transmission SV <input type="checkbox"/> : SV (desired value) transmission MV <input type="checkbox"/> : MV (manipulated variable) transmission DV <input type="checkbox"/> : DV (deviation) transmission	
	Transmission output high limit PV, SV transmission: Transmission output low limit to Input range high limit value MV transmission: Transmission output low limit to 105.0 (%) DV transmission: Transmission output low limit to Scaling span	
	Transmission output low limit PV, SV transmission: Input range low limit to Transmission output high limit value MV transmission: -5.0 to Transmission output high limit value (%) DV transmission: -Scaling span to Transmission output high limit value	

Other function group

Character	Setting item	Data
	Other function group	
	Set value lock - - - - (Unlock): All set values can be changed. Loc 1 <input type="checkbox"/> (Lock 1): None of the set values can be changed. Loc 2 <input type="checkbox"/> (Lock 2): Only SV (desired value) can be changed. Loc 3 <input type="checkbox"/> (Lock 3): None of the set values can be changed as Lock 1. Loc 4 <input type="checkbox"/> (Lock 4): SV and Alarm value can be changed. Other set values cannot be changed.	
	PID zone function NoNE <input type="checkbox"/> : Not used U4E <input type="checkbox"/> : Used	
	SV rise rate 0 to 10000°C/min (°F/min) Thermocouple, RTD input with a decimal point: 0.0 to 1000.0°C/min (°F/min) DC voltage, current input: 0 to 10000/min (The placement of the decimal point follows the selection.)	

	<p>SV fall rate 0 to 10000°C/min (°F/min) Thermocouple, RTD input with a decimal point: 0.0 to 1000.0°C/min (°F/min) DC voltage, current input: 0 to 10000/min (The placement of the decimal point follows the selection.)</p>	
	<p>Indication when output OFF OFF: OFF indication R OFF: No indication PV: PV indication PV AL: PV indication+ Any event from EVT1 to EVT5 output</p>	
	<p>Backlight ALL: All (displays and indicators) are backlit. PV: Only PV display is backlit. SV: Only SV display is backlit. Ac: Only Action indicators are backlit. PV SV: PV and SV displays are backlit. PV Ac: PV display and Action indicators are backlit. SV Ac: SV display and Action indicators are backlit.</p>	
	<p>PV color GRN: Green REd: Red oRD: Orange ALGR: When any alarm output from EVT1 to EVT5 is ON, PV color turns from green to red. ALoRD: When any alarm output from EVT1 to EVT5 is ON, PV color turns from orange to red. PVGR: PV color changes continuously (Orange → Green → Red). APGR: PV color changes continuously (Orange → Green → Red), and simultaneously when any alarm output from EVT1 to EVT5 is ON (Red).</p>	
	<p>PV color range 0.1 to 100.0°C(°F) DC voltage, current input: 1 to 1000 (The placement of the decimal point follows the selection.)</p>	
	<p>Backlight time 0 to 99 minutes</p>	
	<p>Bar graph MV: MV (manipulated variable) indication dV: DV (deviation) indication NoNE: No indication</p>	
	<p>Deviation unit 1 to Converted value of 20% of the input span</p>	

***** Inquiry *****

For any inquiries about this unit, please contact our agency or the shop where you purchased the unit after checking the following.

[Example]

- Model ----- ACD-13A-R/M
- Option ----- A3, C5
- Serial number ----- No. xxxxxxxx

In addition to the above, please let us know the details of the malfunction, if any, and the operating conditions.

SHINKO TECHNOS CO.,LTD.
OVERSEAS DIVISION

Reg. Office : 2-5-1, Senbahigashi, Minoo, Osaka, Japan

URL : <http://www.shinko-technos.co.jp>

E-mail : overseas@shinko-technos.co.jp

Tel : 81-72-727-6100

Fax: 81-72-727-7006