

Netz-Thyristor-Modul
Phase Control Thyristor Module
TT122N

TT122N

TT122N...K...A

TD122N

Elektrische Eigenschaften / Electrical properties

Höchstzulässige Werte / Maximum rated values

| | | | | | |
|--|--|----------------------------------|--------------|----------------|--------------------------------------|
| Periodische Vorwärts- und Rückwärts-Spitzensperrspannung repetitive peak forward off-state and reverse voltages | $T_{vj} = -40^{\circ}\text{C} \dots T_{vj \max}$ | $V_{\text{DRM}}, V_{\text{RRM}}$ | 1800 2200 | 2000 2400 | V V ⁽¹⁾ |
| Vorwärts-Stoßspitzensperrspannung non-repetitive peak forward off-state voltage | $T_{vj} = -40^{\circ}\text{C} \dots T_{vj \max}$ | V_{DSM} | 1800 2200 | 2000 2400 | V V |
| Rückwärts-Stoßspitzensperrspannung non-repetitive peak reverse voltage | $T_{vj} = +25^{\circ}\text{C} \dots T_{vj \max}$ | V_{RSM} | 1900 2300 | 2100 2500 | V V |
| Durchlaßstrom-Grenzeffektivwert maximum RMS on-state current | | I_{TRMSM} | | 220 | A |
| Dauergrenzstrom average on-state current | $T_C = 85^{\circ}\text{C}$ $T_C = 76^{\circ}\text{C}$ | I_{TAVM} | | 122 140 | A A |
| Stoßstrom-Grenzwert surge current | $T_{vj} = 25^{\circ}\text{C}, t_p = 10 \text{ ms}$ $T_{vj} = T_{vj \max}, t_p = 10 \text{ ms}$ | I_{TSM} | | 3300 2950 | A A |
| Grenzlastintegral I^2t -value | $T_{vj} = 25^{\circ}\text{C}, t_p = 10 \text{ ms}$ $T_{vj} = T_{vj \max}, t_p = 10 \text{ ms}$ | I^2t | | 54450 43500 | A ² s A ² s |
| Kritische Stromsteilheit critical rate of rise of on-state current | DIN IEC 747-6 $f = 50 \text{ Hz}$, $i_{\text{GM}} = 1 \text{ A}, di_{\text{G}}/dt = 1 \text{ A}/\mu\text{s}$ | $(di_{\text{T}}/dt)_{\text{cr}}$ | | 100 | A/ μs |
| Kritische Spannungssteilheit critical rate of rise of off-state voltage | $T_{vj} = T_{vj \max}, V_{\text{D}} = 0,67 V_{\text{DRM}}$ 6.Kennbuchstabe / 6 th letter C 6.Kennbuchstabe / 6 th letter F | $(dv_{\text{D}}/dt)_{\text{cr}}$ | | 500 1000 | V/ μs V/ μs |

Charakteristische Werte / Characteristic values

| | | | | | |
|---|---|------------------------------|--------------|---------|---------------|
| Durchlaßspannung on-state voltage | $T_{vj} = T_{vj \max}, i_{\text{T}} = 400 \text{ A}$ | V_{T} | max. | 1,95 | V |
| Schleusenspannung threshold voltage | $T_{vj} = T_{vj \max}$ | $V_{(\text{TO})}$ | | 1,00 | V |
| Ersatzwiderstand slope resistance | $T_{vj} = T_{vj \max}$ | r_{T} | | 2,15 | m Ω |
| Zündstrom gate trigger current | $T_{vj} = 25^{\circ}\text{C}, V_{\text{D}} = 6 \text{ V}$ | I_{GT} | max. | 200 | mA |
| Zündspannung gate trigger voltage | $T_{vj} = 25^{\circ}\text{C}, V_{\text{D}} = 6 \text{ V}$ | V_{GT} | max. | 2 | V |
| Nicht zündender Steuerstrom gate non-trigger current | $T_{vj} = T_{vj \max}, V_{\text{D}} = 6 \text{ V}$ $T_{vj} = T_{vj \max}, V_{\text{D}} = 0,5 V_{\text{DRM}}$ | I_{GD} | max. max. | 10 5 | mA mA |
| Nicht zündende Steuerspannung gate non-trigger voltage | $T_{vj} = T_{vj \max}, V_{\text{D}} = 0,5 V_{\text{DRM}}$ | V_{GD} | max. | 0,25 | V |
| Haltestrom holding current | $T_{vj} = 25^{\circ}\text{C}, V_{\text{D}} = 6 \text{ V}, R_{\text{A}} = 5 \Omega$ | I_{H} | max. | 300 | mA |
| Einraststrom latching current | $T_{vj} = 25^{\circ}\text{C}, V_{\text{D}} = 6 \text{ V}, R_{\text{GK}} \geq 10 \Omega$ $i_{\text{GM}} = 1 \text{ A}, di_{\text{G}}/dt = 1 \text{ A}/\mu\text{s}, t_{\text{g}} = 20 \mu\text{s}$ | I_{L} | max. | 1200 | mA |
| Vorwärts- und Rückwärts-Sperrstrom forward off-state and reverse current | $T_{vj} = T_{vj \max}$ $V_{\text{D}} = V_{\text{DRM}}, V_{\text{R}} = V_{\text{RRM}}$ | $i_{\text{D}}, i_{\text{R}}$ | max. | 30 | mA |
| Zündverzögerung gate controlled delay time | DIN IEC 747-6 $T_{vj} = 25^{\circ}\text{C}$, $i_{\text{GM}} = 1 \text{ A}, di_{\text{G}}/dt = 1 \text{ A}/\mu\text{s}$ | t_{gd} | max. | 4 | μs |

(1) 2400V auf Anfrage/ 2400V on request

| | | | |
|--------------|------------|----------------------|----------|
| prepared by: | C.Drilling | date of publication: | 01.07.02 |
| approved by: | J. Novotny | Revision: | 1 |

Netz-Thyristor-Modul
Phase Control Thyristor Module
TT122N
Elektrische Eigenschaften / Electrical properties

Charakteristische Werte / Characteristic values

| | | | | | |
|--|--|------------|------|------------|---------------|
| Freiwerdezeit circuit commutated turn-off time | $T_{vj} = T_{vj\max}$, $i_{TM} = I_{TAVM}$ $V_{RM} = 100\text{ V}$, $V_{DM} = 0,67 V_{DRM}$ $dv_D/dt = 20\text{ V}/\mu\text{s}$, $-di_T/dt = 10\text{ A}/\mu\text{s}$ 5.Kennbuchstabe / 5 th letter O | t_q | typ. | 300 | μs |
| Isolations-Prüfspannung insulation test voltage | RMS, $f = 50\text{ Hz}$, $t = 1\text{ min}$ RMS, $f = 50\text{ Hz}$, $t = 1\text{ sec}$ | V_{ISOL} | | 2,5 3,0 | kV kV |

Thermische Eigenschaften / Thermal properties

| | | | | | |
|--|--|-------------------|------|----------------------------------|--|
| Innerer Wärmewiderstand thermal resistance, junction to case | pro Modul / per Module, $\Theta = 180^\circ\text{ sin}$ pro Zweig / per arm, $\Theta = 180^\circ\text{ sin}$ pro Modul / per Module, DC pro Zweig / per arm, DC | R_{thJC} | max. | 0,100 0,200 0,096 0,192 | $^\circ\text{C}/\text{W}$ $^\circ\text{C}/\text{W}$ $^\circ\text{C}/\text{W}$ $^\circ\text{C}/\text{W}$ |
| Übergangs-Wärmewiderstand thermal resistance, case to heatsink | pro Modul / per Module pro Zweig / per arm | R_{thCH} | max. | 0,03 0,06 | $^\circ\text{C}/\text{W}$ $^\circ\text{C}/\text{W}$ |
| Höchstzulässige Sperrschichttemperatur maximum junction temperature | | $T_{vj\max}$ | | 125 | $^\circ\text{C}$ |
| Betriebstemperatur operating temperature | | $T_{c\text{ op}}$ | | -40...+125 | $^\circ\text{C}$ |
| Lagertemperatur storage temperature | | T_{stg} | | -40...+130 | $^\circ\text{C}$ |

Mechanische Eigenschaften / Mechanical properties

| | | | | | |
|---|---------------------------------|----|------|-------------------|-----------------------|
| Gehäuse, siehe Anlage case, see annex | | | | Seite 3 page 3 | |
| Si-Element mit Druckkontakt Si-pellet with pressure contact | | | | | |
| Innere Isolation internal insulation | | | | AIN | |
| Anzugsdrehmoment für mechanische Anschlüsse mounting torque | Toleranz / Tolerance $\pm 15\%$ | M1 | | 6 | Nm |
| Anzugsdrehmoment für elektrische Anschlüsse terminal connection torque | Toleranz / Tolerance $\pm 10\%$ | M2 | | 6 | Nm |
| Steueranschlüsse control terminals | DIN 46 244 | | | A 2,8 x 0,8 | |
| Gewicht weight | | G | typ. | 310 | g |
| Kriechstrecke creepage distance | | | | 15 | mm |
| Schwingfestigkeit vibration resistance | $f = 50\text{ Hz}$ | | | 50 | m/s^2 |
|  | file-No. | | | E 83336 | |

Mit diesem Datenblatt werden Halbleiterbauelemente spezifiziert, jedoch keine Eigenschaften zugesichert. Es gilt in Verbindung mit den zugehörigen technischen Erläuterungen.

This data sheet specifies semiconductor devices, but promises no characteristics. It is valid in combination with the belonging technical notes.



Netz-Thyristor-Modul
Phase Control Thyristor Module

TT122N

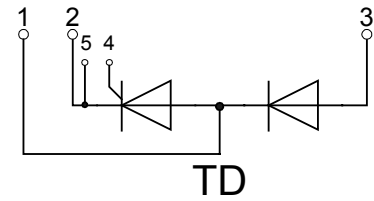
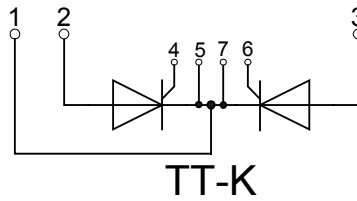
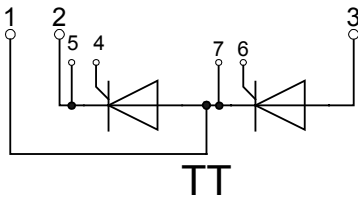
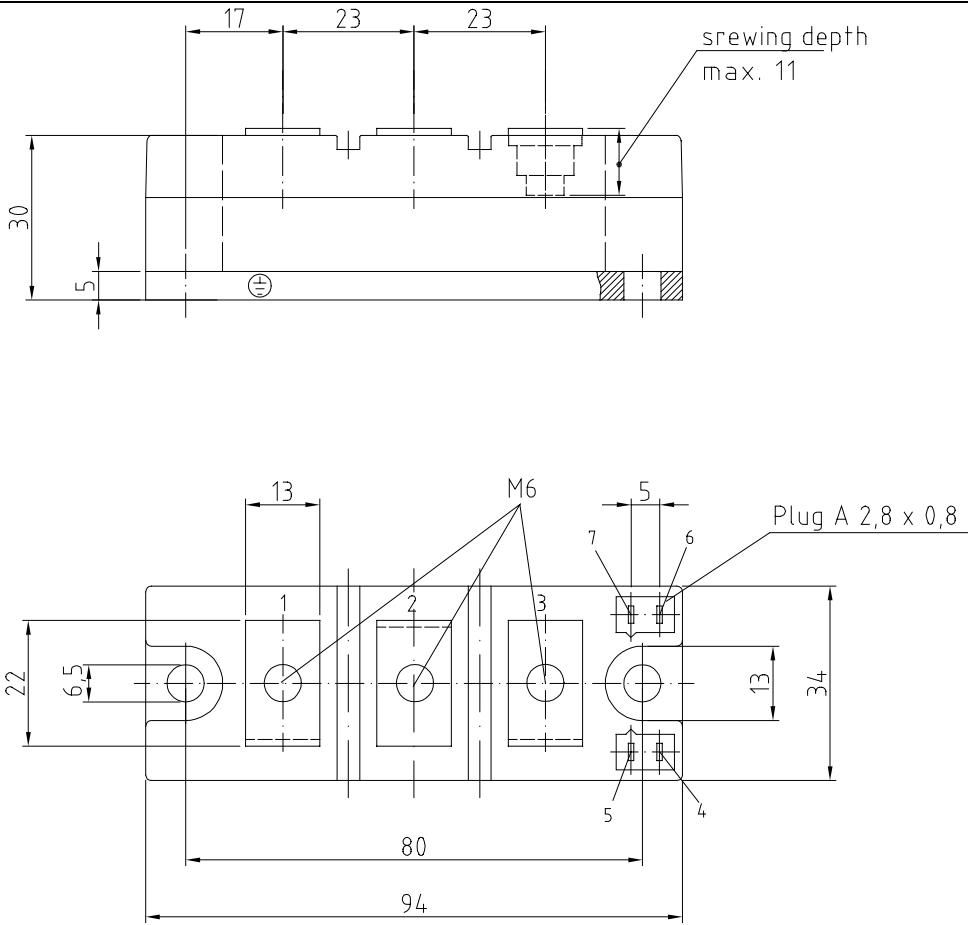



Netz-Thyristor-Modul
Phase Control Thyristor Module

TT122N

Analytische Elemente des transienten Wärmewiderstandes Z_{thJC} für DC
Analytical elements of transient thermal impedance Z_{thJC} for DC

| Pos. n | 1 | 2 | 3 | 4 | 5 | 6 | 7 |
|------------------|--------|--------|--------|-------|---|---|---|
| R_{thn} [°C/W] | 0,0094 | 0,0224 | 0,0586 | 0,102 | | | |
| τ_n [s] | 0,0014 | 0,0253 | 0,267 | 1,68 | | | |

Analytische Funktion / Analytical function:
$$Z_{thJC} = \sum_{n=1}^{n_{max}} R_{thn} \left(1 - e^{-\frac{t}{\tau_n}} \right)$$

Luftselbstkühlung / Natural cooling
3 Module pro Kühlkörper / 3 modules per heatsink
Kühlkörper / Heatsink type: KM17 (45W)

Analytische Elemente des transienten Wärmewiderstandes Z_{thCA}
Analytical elements of transient thermal impedance Z_{thCA}

| Pos. n | 1 | 2 | 3 | 4 | 5 | 6 | 7 |
|------------------|------|-------|-------|---|---|---|---|
| R_{thn} [°C/W] | 1,71 | 0,135 | 0,013 | | | | |
| τ_n [s] | 1200 | 14 | 4 | | | | |

Verstärkte Kühlung / Forced cooling
3 Module pro Kühlkörper / 3 modules per heatsink
Kühlkörper / Heatsink type: KM17 (Papst 4650N)

Analytische Elemente des transienten Wärmewiderstandes Z_{thCA}
Analytical elements of transient thermal impedance Z_{thCA}

| Pos. n | 1 | 2 | 3 | 4 | 5 | 6 | 7 |
|------------------|-------|-------|-------|---|---|---|---|
| R_{thn} [°C/W] | 0,515 | 0,119 | 0,026 | | | | |
| τ_n [s] | 354 | 13,6 | 2,41 | | | | |

Analytische Funktion / Analytical function:
$$Z_{thCA} = \sum_{n=1}^{n_{max}} R_{thn} \left(1 - e^{-\frac{t}{\tau_n}} \right)$$

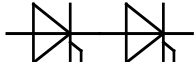

Netz-Thyristor-Modul
Phase Control Thyristor Module

TT122N

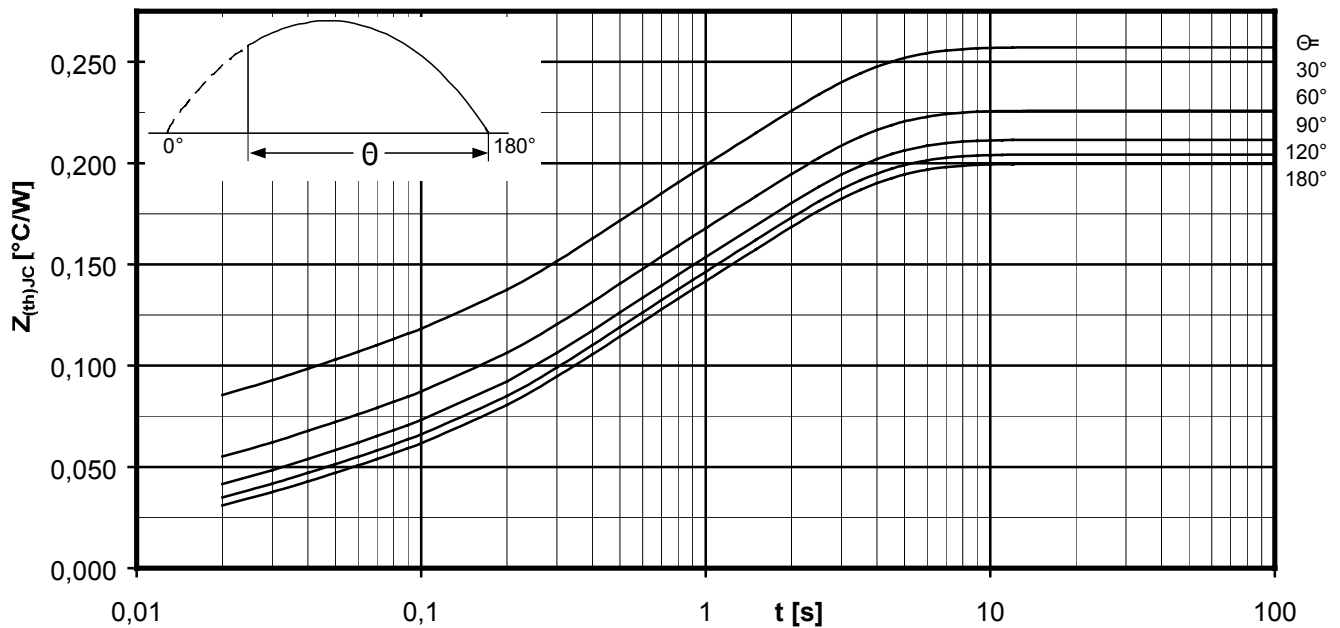

Transienter innerer Wärmewiderstand je Zweig / Transient thermal impedance per arm $Z_{thJC} = f(t)$

Sinusförmiger Strom / Sinusoidal current

Parameter: Stromflußwinkel Θ / Current conduction angle Θ

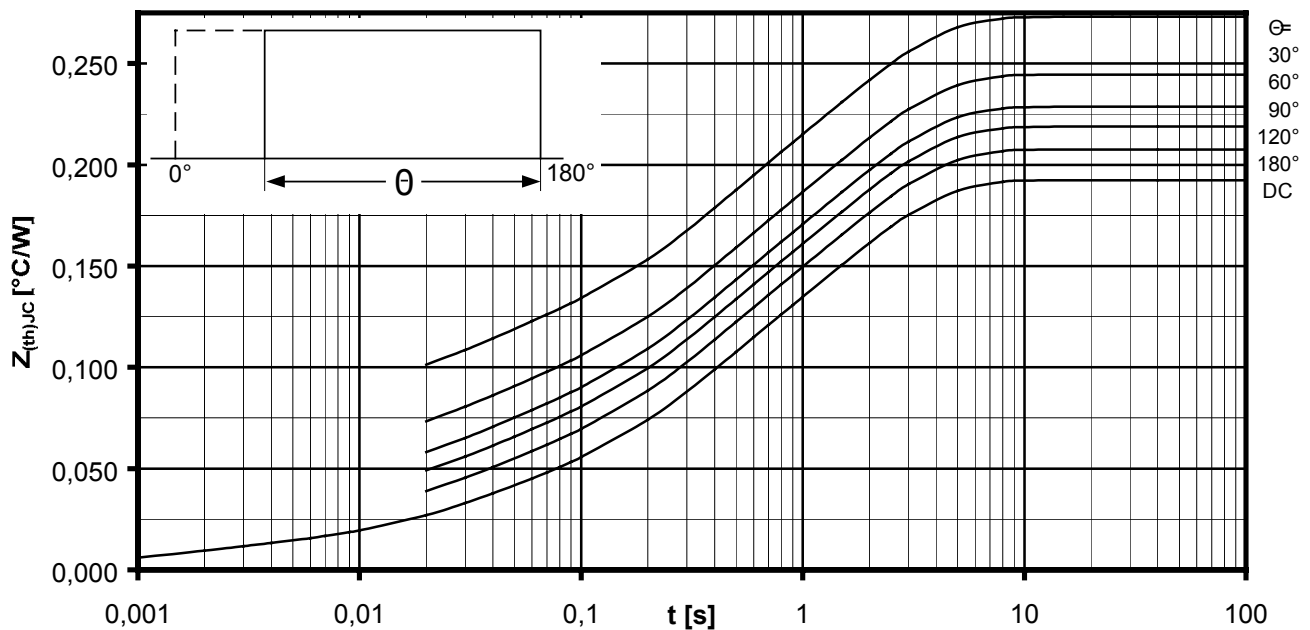

Transienter innerer Wärmewiderstand je Zweig / Transient thermal impedance per arm $Z_{thJC} = f(t)$

Rechteckförmiger Strom / Rectangular current

Parameter: Stromflußwinkel Θ / Current conduction angle Θ



Netz-Thyristor-Modul
Phase Control Thyristor Module

TT122N

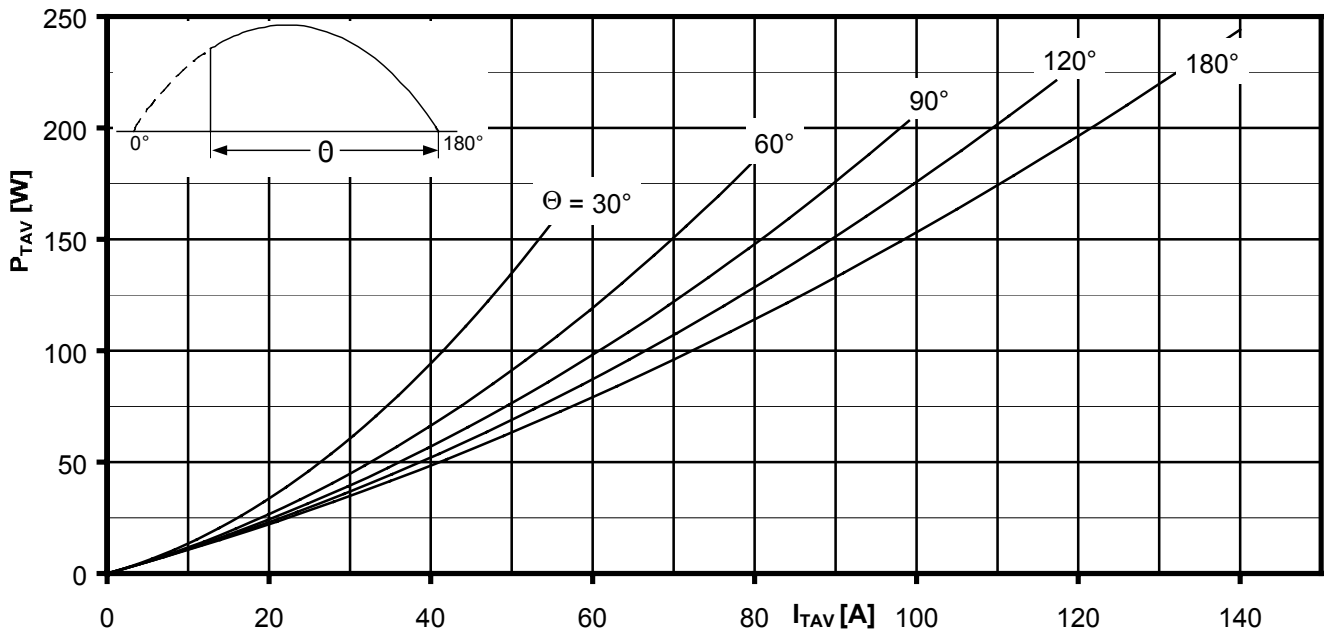

Durchlassverlustleistung je Zweig / On-state power loss per arm $P_{TAV} = f(I_{TAV})$

Sinusförmiger Strom / Sinusoidal current Strombelastung je Zweig / Current load per arm

Berechnungsgrundlage P_{TAV} (Schaltverluste gesondert berücksichtigen)
Calculation base P_{TAV} (switching losses should be considered separately)

Parameter: Stromflußwinkel / Current conduction angle Θ

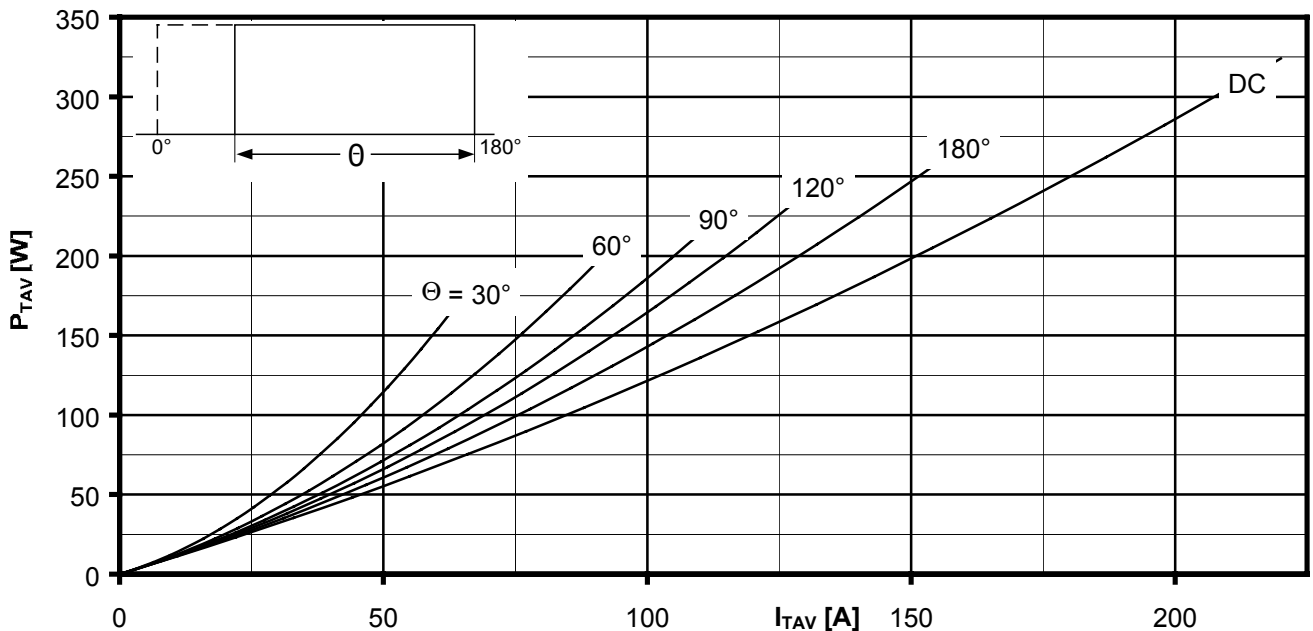

Durchlassverlustleistung je Zweig / On-state power loss per arm $P_{TAV} = f(I_{TAV})$

Rechteckförmiger Strom / Rectangular current Strombelastung je Zweig / Current load per arm

Berechnungsgrundlage P_{TAV} (Schaltverluste gesondert berücksichtigen)
Calculation base P_{TAV} (switching losses should be considered separately)

Parameter: Stromflußwinkel / Current conduction angle Θ



Netz-Thyristor-Modul
Phase Control Thyristor Module

TT122N

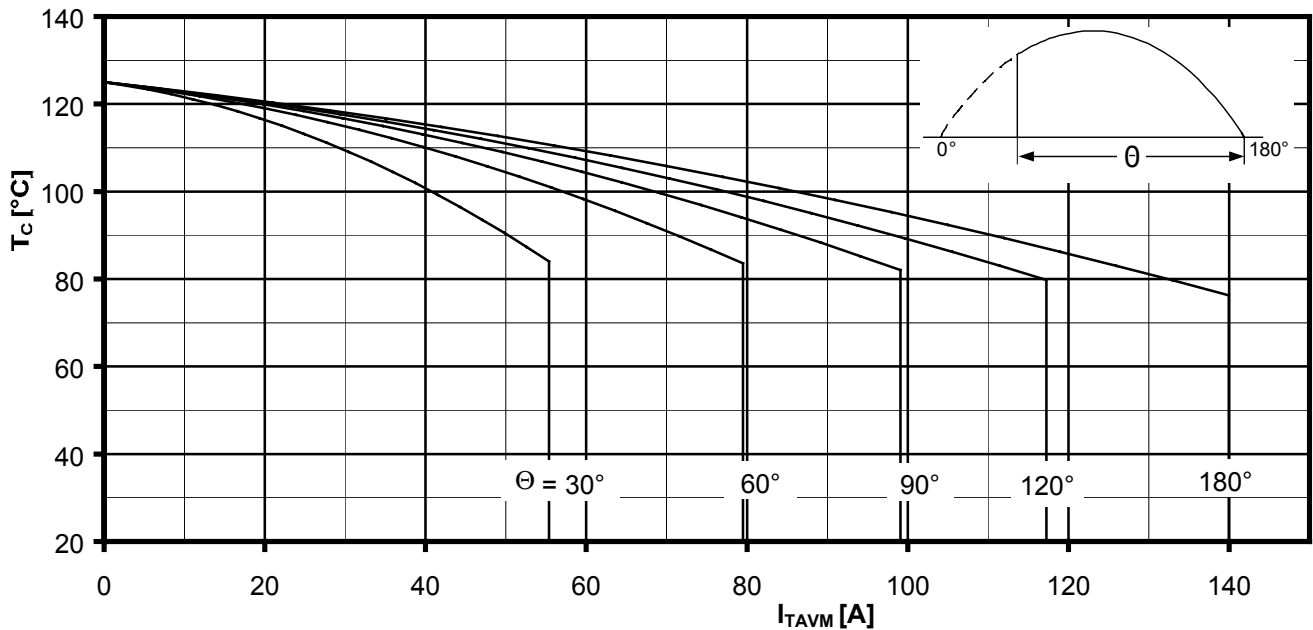

Höchstzulässige Gehäusetemperatur / Maximum allowable case temperature $T_c = f(I_{TAVM})$

Sinusförmiger Strom / Sinusoidal current Strombelastung je Zweig / Current load per arm

Berechnungsgrundlage P_{TAV} (Schaltverluste gesondert berücksichtigen)
Calculation base P_{TAV} (switching losses should be considered separately)

Parameter: Stromflußwinkel Θ / Current conduction angle Θ

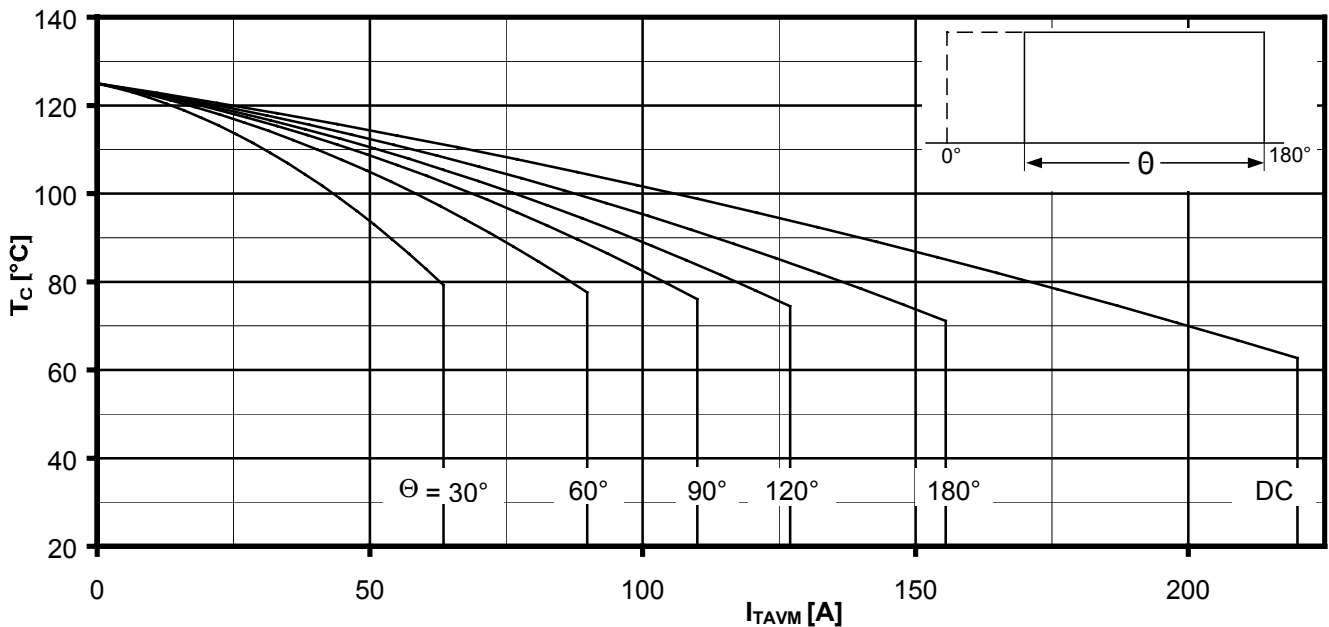

Höchstzulässige Gehäusetemperatur / Maximum allowable case temperature $T_c = f(I_{TAVM})$

Rechteckförmiger Strom / Rectangular current Strombelastung je Zweig / Current load per arm

Berechnungsgrundlage P_{TAV} (Schaltverluste gesondert berücksichtigen)
Calculation base P_{TAV} (switching losses should be considered separately)

Parameter: Stromflußwinkel Θ / Current conduction angle Θ



Netz-Thyristor-Modul
Phase Control Thyristor Module

TT122N

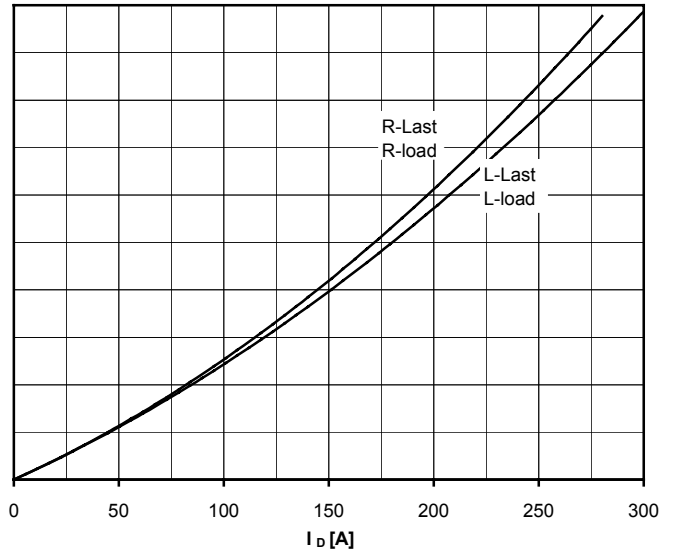
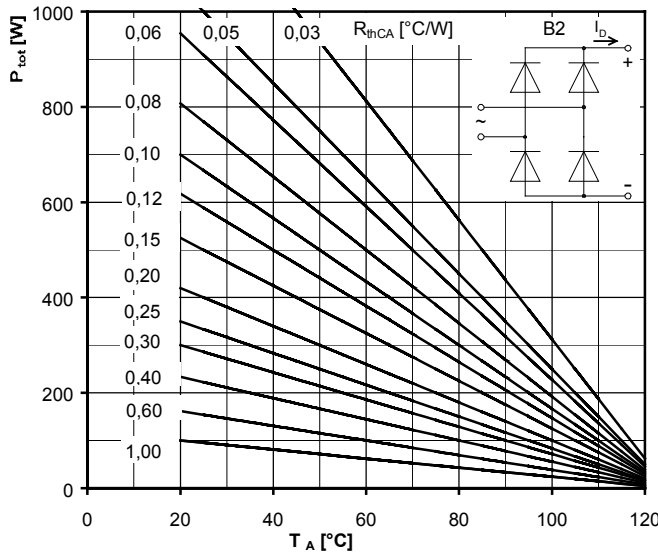

Höchstzulässiger Ausgangsstrom / Maximum rated output current I_D

B2- Zweipuls-Brückenschaltung / Two-pulse bridge circuit

Gesamtverlustleistung der Schaltung / Total power dissipation at circuit P_{tot}

Parameter:

Wärmewiderstand zwischen den Gehäusen und Umgebung / Thermal resistance cases to ambient R_{thCA}

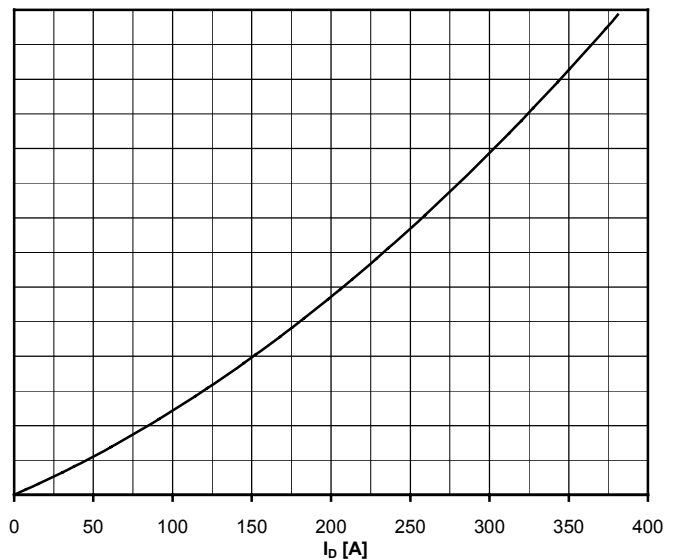
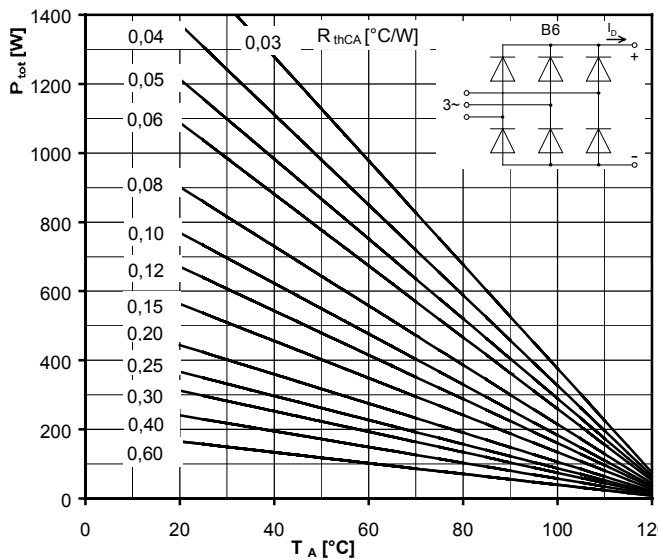

Höchstzulässiger Ausgangsstrom / Maximum rated output current I_D

B6- Sechspuls-Brückenschaltung / Six-pulse bridge circuit

Gesamtverlustleistung der Schaltung / Total power dissipation at circuit P_{tot}

Parameter:

Wärmewiderstand zwischen den Gehäusen und Umgebung / Thermal resistance cases to ambient R_{thCA}



Netz-Thyristor-Modul
Phase Control Thyristor Module

TT122N

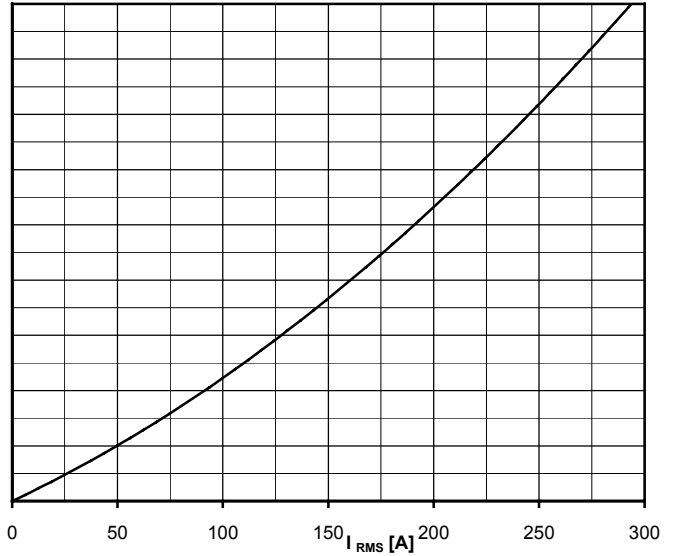
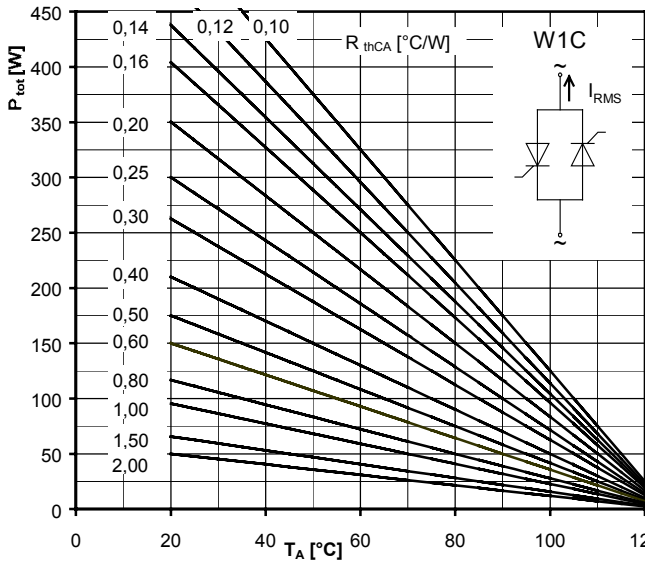

Höchstzulässiger Effektivstrom / Maximum rated RMS current I_{RMS}

W1C - Einphasen-Wechselwegschaltung / Single-phase inverse parallel circuit

Gesamtverlustleistung der Schaltung / Total power dissipation at circuit P_{tot}

Parameter:

Wärmewiderstand zwischen den Gehäusen und Umgebung / Thermal resistance case to ambient R_{thCA}

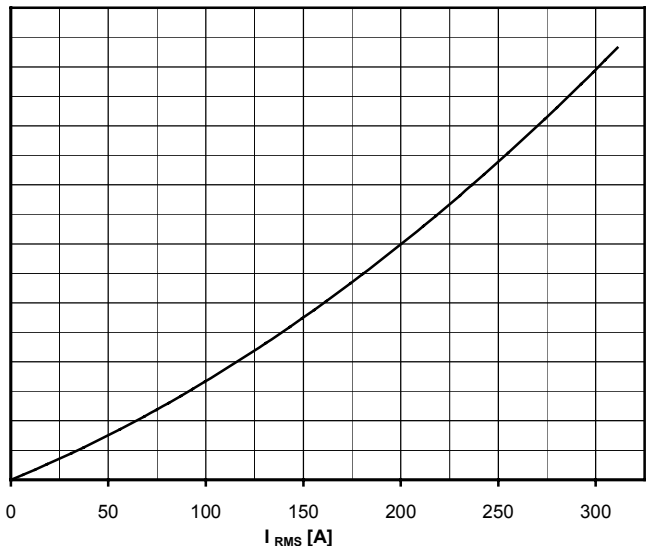
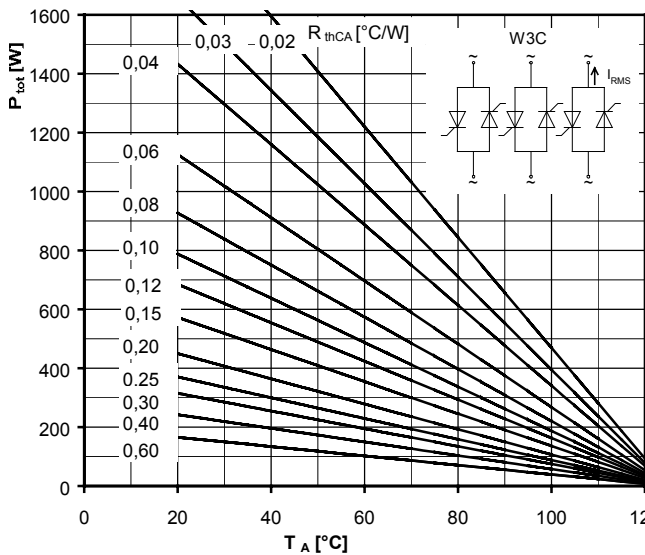

Höchstzulässiger Effektivstrom / Maximum rated RMS current I_{RMS}

W3C - Dreiphasen-Wechselwegschaltung / Three-phase inverse parallel circuit

Gesamtverlustleistung der Schaltung / Total power dissipation at circuit P_{tot}

Parameter:

Wärmewiderstand zwischen den Gehäusen und Umgebung / Thermal resistance cases to ambient R_{thCA}



Netz-Thyristor-Modul
Phase Control Thyristor Module

TT122N

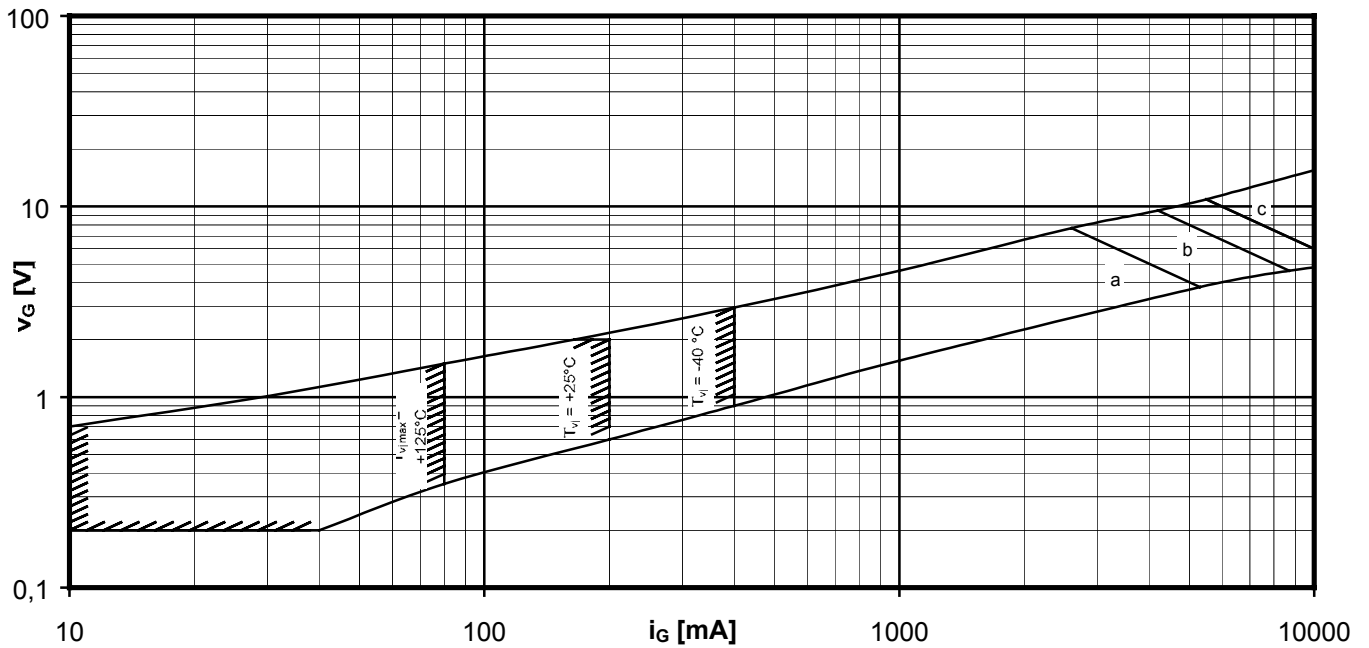

Steuercharakteristik $v_G = f(i_G)$ mit Zündbereichen für $V_D = 6\text{ V}$
Gate characteristic $v_G = f(i_G)$ with triggering area for $V_D = 6\text{ V}$

Höchstzulässige Spitzensteuerverlustleistung / Maximum rated peak gate power dissipation $P_{GM} = f(t_g)$:

a - 20 W/10ms b - 40 W/1ms c - 60 W/0,5ms

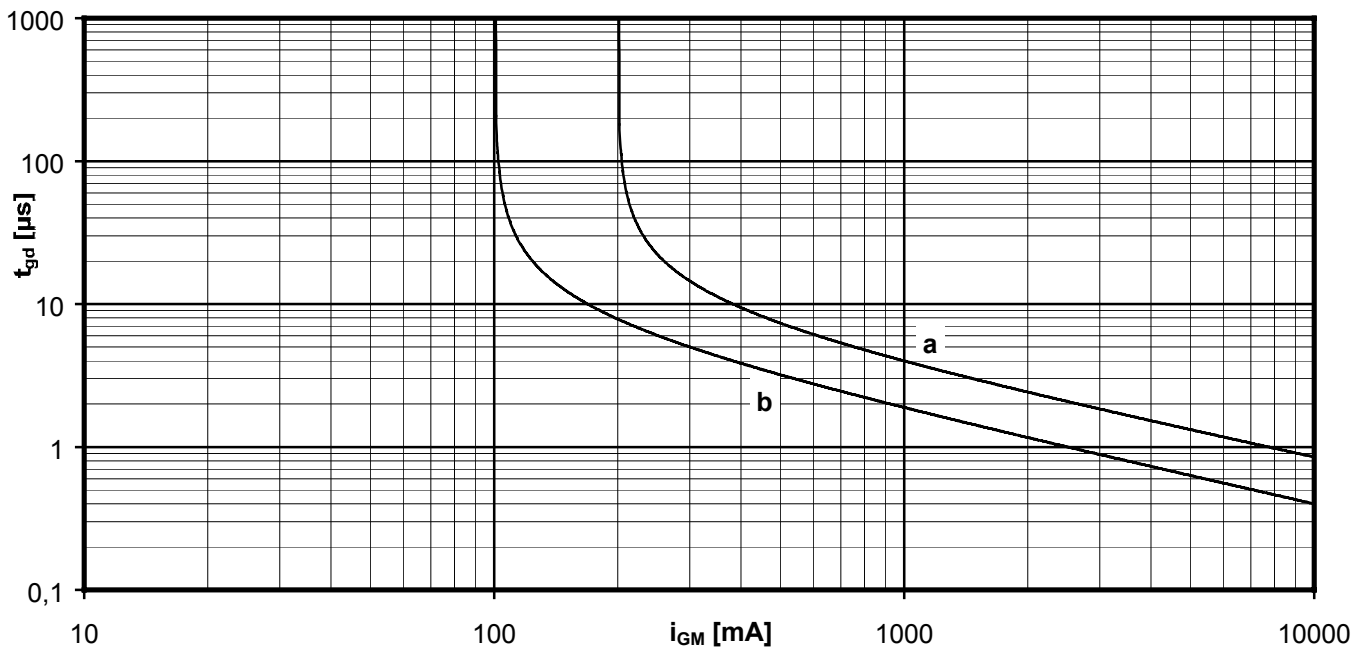

Zündverzug / Gate controlled delay time $t_{gd} = f(i_G)$

$T_{vj} = 25^\circ\text{C}$, $di_G/dt = i_{GM}/1\mu\text{s}$

a - maximaler Verlauf / Limiting characteristic

b - typischer Verlauf / Typical characteristic



Netz-Thyristor-Modul
Phase Control Thyristor Module

TT122N

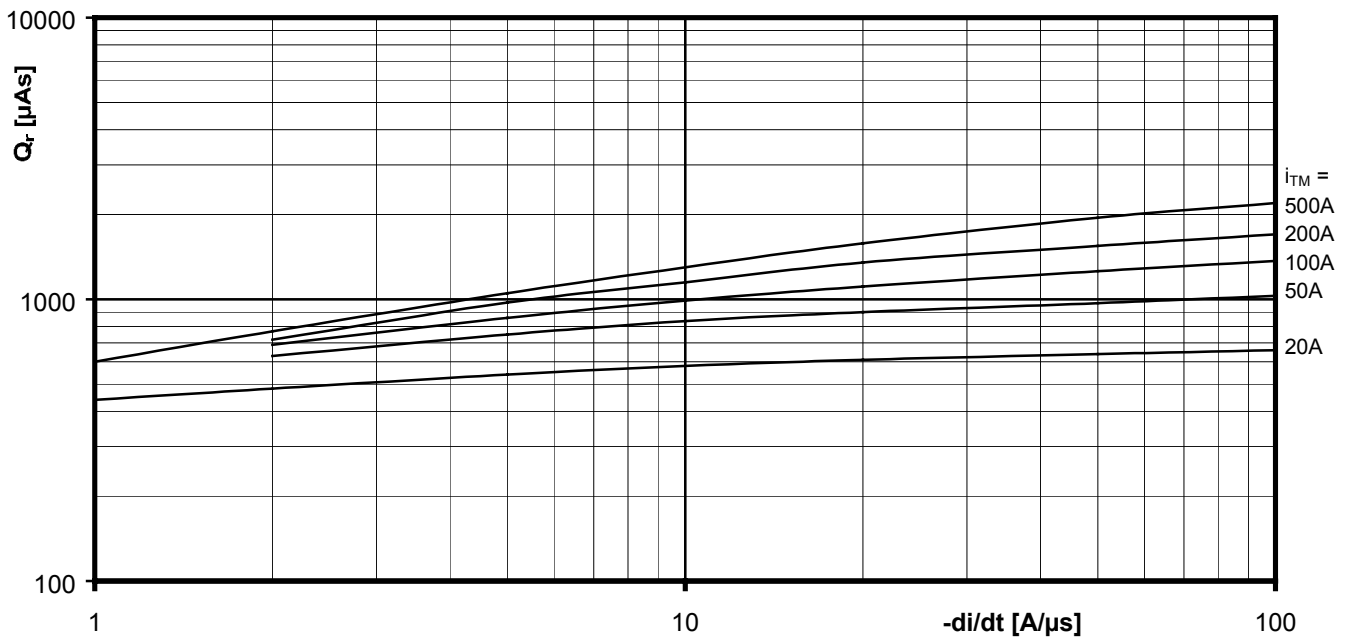

Sperrverzögerungsladung / Recovered charge $Q_r = f(-di/dt)$

$$T_{vj} = T_{vjmax}, V_R \leq 0,5 V_{RRM}, V_{RM} = 0,8 V_{RRM}$$

Parameter: Durchlaßstrom / On-state current i_{TM}

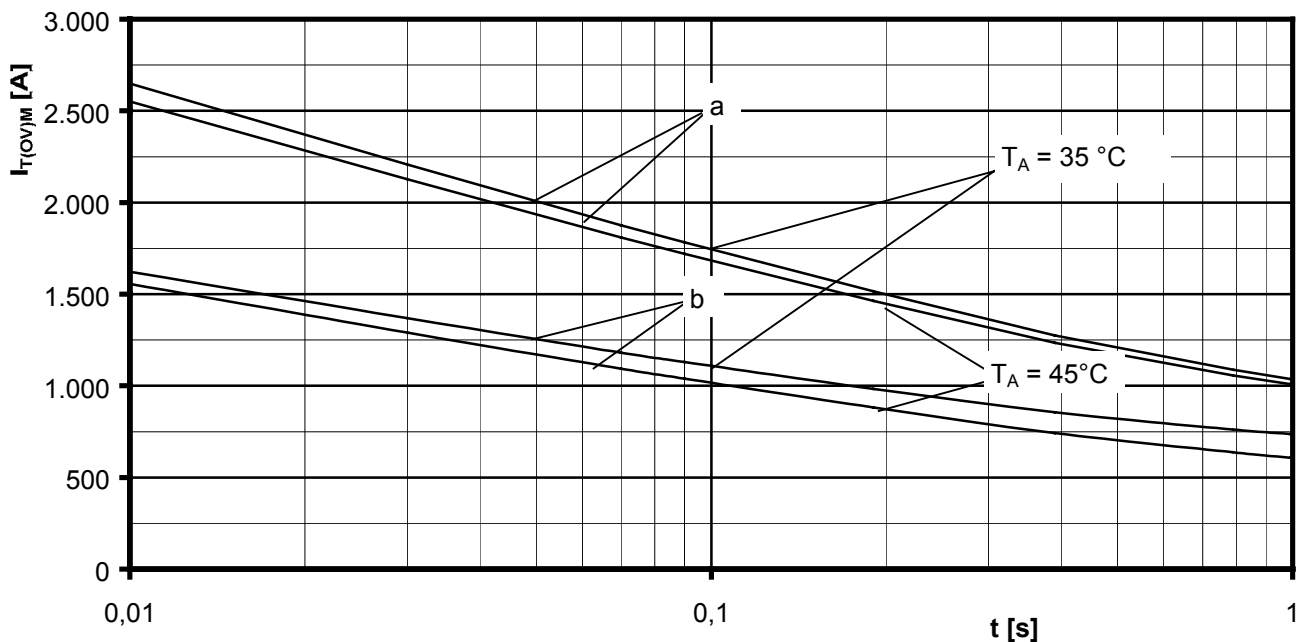

Grenzstrom / Maximum overload on-state current $I_{T(OV)M} = f(t), V_{RM} = 0,8 V_{RRM}$

a: Leerlauf / No-load conditions

b: nach Belastung mit I_{TAVM} / after load with I_{TAVM}

$T_A = 35^\circ\text{C}$, verstärkte Luftkühlung / Forced air cooling

$T_A = 45^\circ\text{C}$, Luftselbstkühlung / Natural air cooling



Netz-Thyristor-Modul
Phase Control Thyristor Module

TT122N

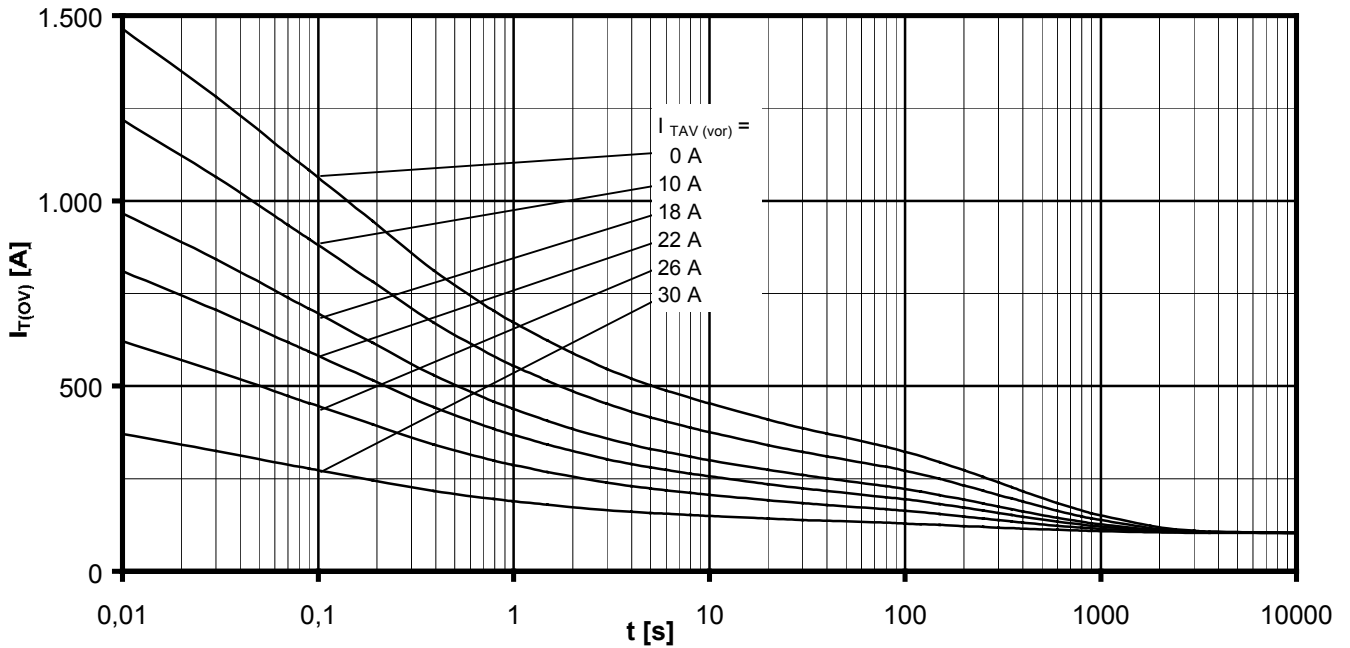

Überstrom je Zweig / Overload on-state current $I_{T(ov)}$

B6- Sechspuls-Brückenschaltung, 120° Rechteck / Six-pulse bridge circuit, 120° rectangular

Kühlkörper / Heatsink type KM17 (45W) Luftselbstkühlung bei / Natural cooling at $T_A = 45^\circ\text{C}$

Parameter: Vorlaststrom je Zweig / Pre-load current per arm $I_{TAV(vor)}$

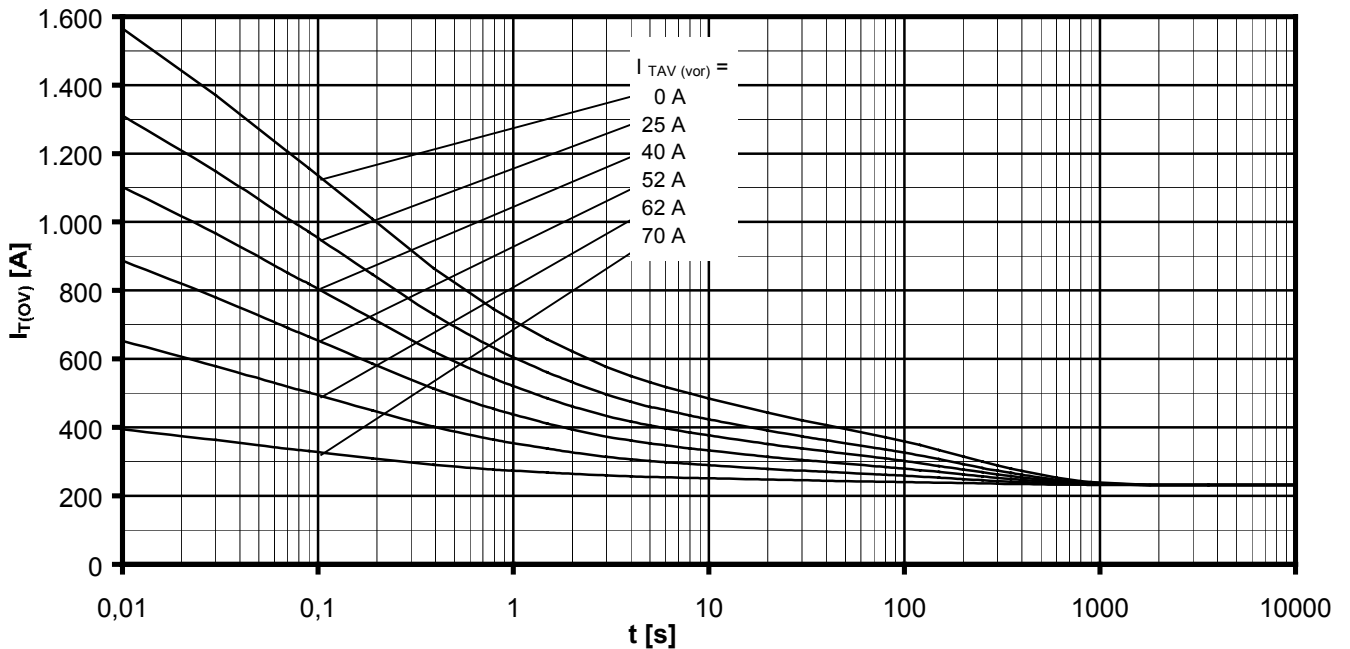

Überstrom je Zweig / Overload on-state current $I_{T(ov)}$

B6- Sechspuls-Brückenschaltung, 120° Rechteck / Six-pulse bridge circuit, 120° rectangular

Kühlkörper / Heatsink type KM17 (Papst 4650N) Verstärkte Kühlung bei / Forced cooling at $T_A = 35^\circ\text{C}$

Parameter: Vorlaststrom je Zweig / Pre-load current per arm $I_{TAV(vor)}$