

Netz-Thyristor-Modul
Phase Control Thyristor Module
TT250N
TT250N
TT250N...-K
TD250N
TD250N...-A
DT250N
DT250N...-K
Elektrische Eigenschaften / Electrical properties

Höchstzulässige Werte / Maximum rated values

Periodische Vorwärts- und Rückwärts-Spitzenspannung repetitive peak forward off-state and reverse voltages	$T_{vj} = -40^{\circ}\text{C} \dots T_{vj \max}$	$V_{\text{DRM}}, V_{\text{RRM}}$	1200 1600	1400 1800	V V
Vorwärts-Stoßspitzenspannung non-repetitive peak forward off-state voltage	$T_{vj} = -40^{\circ}\text{C} \dots T_{vj \max}$	V_{DSM}	1200 1600	1400 1800	V V
Rückwärts-Stoßspitzenspannung non-repetitive peak reverse voltage	$T_{vj} = +25^{\circ}\text{C} \dots T_{vj \max}$	V_{RSM}	1300 1700	1500 1900	V V
Durchlaßstrom-Grenzeffektivwert maximum RMS on-state current		I_{TRMSM}		410	A
Dauergrenzstrom average on-state current	$T_{\text{C}} = 85^{\circ}\text{C}$ $T_{\text{C}} = 82^{\circ}\text{C}$	I_{TAVM}		250 261	A A
Stoßstrom-Grenzwert surge current	$T_{vj} = 25^{\circ}\text{C}, t_{\text{p}} = 10 \text{ ms}$ $T_{vj} = T_{vj \max}, t_{\text{p}} = 10 \text{ ms}$	I_{TSM}		8000 7000	A A
Grenzlastintegral I^2t -value	$T_{vj} = 25^{\circ}\text{C}, t_{\text{p}} = 10 \text{ ms}$ $T_{vj} = T_{vj \max}, t_{\text{p}} = 10 \text{ ms}$	I^2t		320000 245000	A^2s A^2s
Kritische Stromsteilheit critical rate of rise of on-state current	DIN IEC 747-6 $f = 50 \text{ Hz}, i_{\text{GM}} = 1 \text{ A}, di_{\text{G}}/dt = 1 \text{ A}/\mu\text{s}$	$(di_{\text{T}}/dt)_{\text{cr}}$		150	$\text{A}/\mu\text{s}$
Kritische Spannungssteilheit critical rate of rise of off-state voltage	$T_{vj} = T_{vj \max}, v_{\text{D}} = 0,67 V_{\text{DRM}}$ 6.Kennbuchstabe / 6 th letter F	$(dv_{\text{D}}/dt)_{\text{cr}}$		1000	$\text{V}/\mu\text{s}$

Charakteristische Werte / Characteristic values

Durchlaßspannung on-state voltage	$T_{vj} = T_{vj \max}, i_{\text{T}} = 800 \text{ A}$	v_{T}	max.	1,5	V
Schleusenspannung threshold voltage	$T_{vj} = T_{vj \max}$	$V_{(\text{TO})}$		0,8	V
Ersatzwiderstand slope resistance	$T_{vj} = T_{vj \max}$	r_{T}		0,7	$\text{m}\Omega$
Zündstrom gate trigger current	$T_{vj} = 25^{\circ}\text{C}, v_{\text{D}} = 6 \text{ V}$	I_{GT}	max.	200	mA
Zündspannung gate trigger voltage	$T_{vj} = 25^{\circ}\text{C}, v_{\text{D}} = 6 \text{ V}$	V_{GT}	max.	2	V
Nicht zündender Steuerstrom gate non-trigger current	$T_{vj} = T_{vj \max}, v_{\text{D}} = 6 \text{ V}$ $T_{vj} = T_{vj \max}, v_{\text{D}} = 0,5 V_{\text{DRM}}$	I_{GD}	max. max.	10 5	mA mA
Nicht zündende Steuerspannung gate non-trigger voltage	$T_{vj} = T_{vj \max}, v_{\text{D}} = 0,5 V_{\text{DRM}}$	V_{GD}	max.	0,2	V
Haltestrom holding current	$T_{vj} = 25^{\circ}\text{C}, v_{\text{D}} = 6 \text{ V}, R_{\text{A}} = 5 \Omega$	I_{H}	max.	300	mA
Einraststrom latching current	$T_{vj} = 25^{\circ}\text{C}, v_{\text{D}} = 6 \text{ V}, R_{\text{GK}} \geq 10 \Omega$ $i_{\text{GM}} = 1 \text{ A}, di_{\text{G}}/dt = 1 \text{ A}/\mu\text{s}, t_{\text{g}} = 20 \mu\text{s}$	I_{L}	max.	1200	mA
Vorwärts- und Rückwärts-Sperrstrom forward off-state and reverse current	$T_{vj} = T_{vj \max}$ $v_{\text{D}} = V_{\text{DRM}}, v_{\text{R}} = V_{\text{RRM}}$	$i_{\text{D}}, i_{\text{R}}$	max.	50	mA
Zündverzug gate controlled delay time	DIN IEC 747-6 $T_{vj} = 25^{\circ}\text{C}, i_{\text{GM}} = 1 \text{ A}, di_{\text{G}}/dt = 1 \text{ A}/\mu\text{s}$	t_{gd}	max.	3	μs

prepared by:	C.Drilling	date of publication:	23.09.02
approved by:	J. Novotny	revision:	1

Netz-Thyristor-Modul
Phase Control Thyristor Module
TT250N
Elektrische Eigenschaften / Electrical properties

Charakteristische Werte / Characteristic values

Freiwerdezeit circuit commutated turn-off time	$T_{vj} = T_{vj\max}$, $i_{TM} = I_{TAVM}$ $V_{RM} = 100\text{ V}$, $V_{DM} = 0,67 V_{DRM}$ $dv_D/dt = 20\text{ V}/\mu\text{s}$, $-di_T/dt = 10\text{ A}/\mu\text{s}$ 5.Kennbuchstabe / 5 th letter O	t_q	typ.	250	μs
Isolations-Prüfspannung insulation test voltage	RMS, $f = 50\text{ Hz}$, $t = 1\text{ min}$ RMS, $f = 50\text{ Hz}$, $t = 1\text{ sec}$	V_{ISOL}		3,0 3,6	kV kV

Thermische Eigenschaften / Thermal properties

Innerer Wärmewiderstand thermal resistance, junction to case	pro Modul / per Module, $\Theta = 180^\circ\text{ sin}$ pro Zweig / per arm, $\Theta = 180^\circ\text{ sin}$ pro Modul / per Module, DC pro Zweig / per arm, DC	R_{thJC}	max.	0,065 0,130 0,062 0,124	$^\circ\text{C}/\text{W}$ $^\circ\text{C}/\text{W}$ $^\circ\text{C}/\text{W}$ $^\circ\text{C}/\text{W}$
Übergangs-Wärmewiderstand thermal resistance, case to heatsink	pro Modul / per Module pro Zweig / per arm	R_{thCH}	max.	0,02 0,04	$^\circ\text{C}/\text{W}$ $^\circ\text{C}/\text{W}$
Höchstzulässige Sperrschichttemperatur maximum junction temperature		$T_{vj\max}$		125	$^\circ\text{C}$
Betriebstemperatur operating temperature		$T_{c\text{ op}}$		-40...+125	$^\circ\text{C}$
Lagertemperatur storage temperature		T_{stg}		-40...+130	$^\circ\text{C}$

Mechanische Eigenschaften / Mechanical properties

Gehäuse, siehe Anlage case, see annex				Seite 3 page 3	
Si-Element mit Druckkontakt Si-pellet with pressure contact					
Innere Isolation internal insulation				AIN	
Anzugsdrehmoment für mechanische Anschlüsse mounting torque	Toleranz / Tolerance $\pm 15\%$	M1		5	Nm
Anzugsdrehmoment für elektrische Anschlüsse terminal connection torque	Toleranz / Tolerance $\pm 10\%$	M2		12	Nm
Steueranschlüsse control terminals	DIN 46 244			A 2,8 x 0,8	
Gewicht weight		G	typ.	800	g
Kriechstrecke creepage distance				0	mm
Schwingfestigkeit vibration resistance	$f = 50\text{ Hz}$			50	m/s^2
	file-No.			E 83336	

Mit diesem Datenblatt werden Halbleiterbauelemente spezifiziert, jedoch keine Eigenschaften zugesichert. Es gilt in Verbindung mit den zugehörigen technischen Erläuterungen.

This data sheet specifies semiconductor devices, but promises no characteristics. It is valid in combination with the belonging technical notes.



Netz-Thyristor-Modul
Phase Control Thyristor Module

TT250N

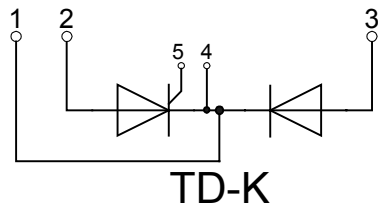
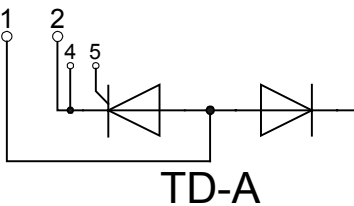
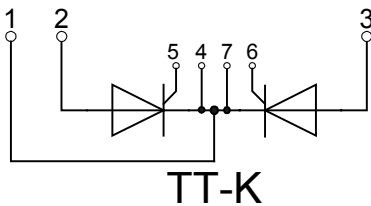
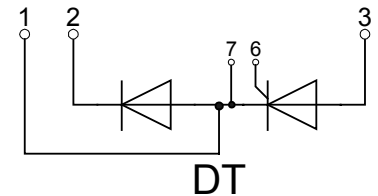
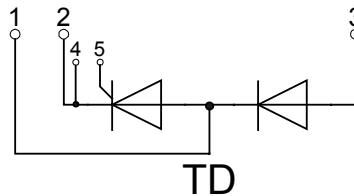
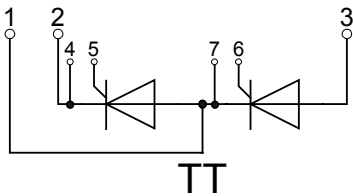
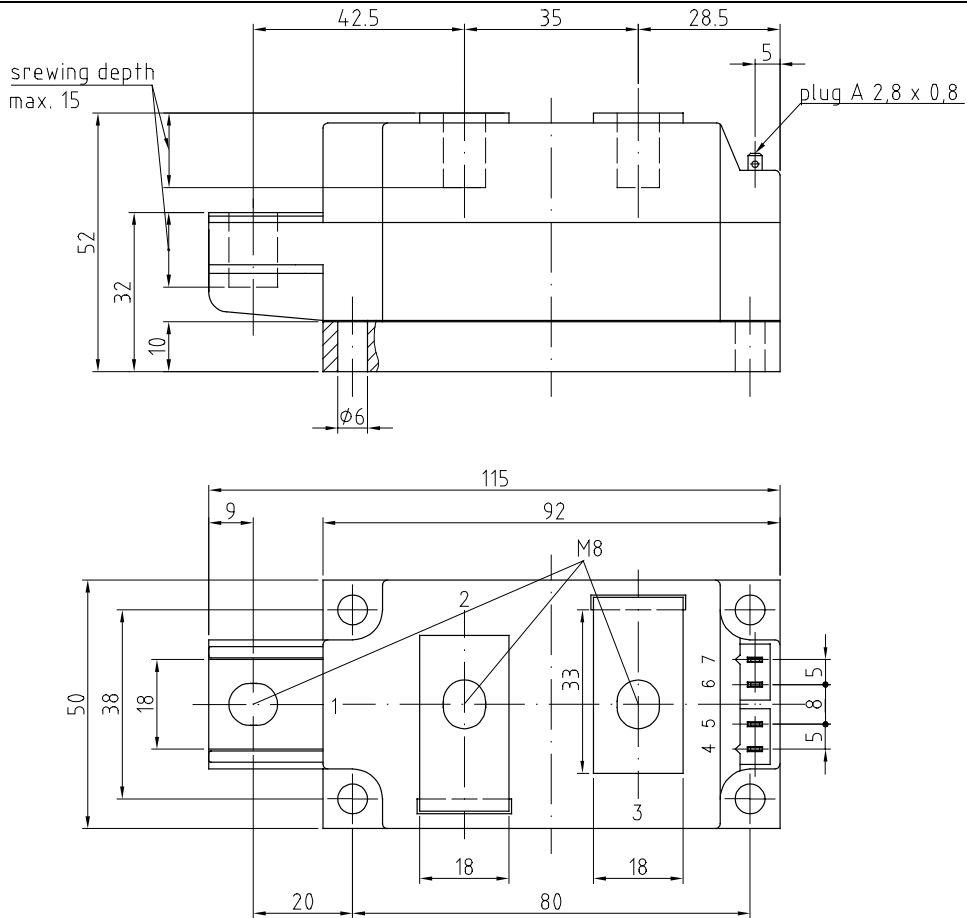



Netz-Thyristor-Modul
Phase Control Thyristor Module

TT250N

Analytische Elemente des transienten Wärmewiderstandes Z_{thJC} für DC
Analytical elements of transient thermal impedance Z_{thJC} for DC

Pos. n	1	2	3	4	5	6	7
R_{thn} [°C/W]	0,0031	0,0097	0,0257	0,0429	0,0426		
τ_n [s]	0,0009	0,008	0,11	0,61	3,06		

Analytische Funktion / Analytical function:
$$Z_{thJC} = \sum_{n=1}^{n_{max}} R_{thn} \left(1 - e^{-\frac{t}{\tau_n}} \right)$$

Luftselbstkühlung / Natural cooling
3 Module pro Kühlkörper / 3 modules per heatsink
Kühlkörper / Heatsink type: KM17 (45W)

Analytische Elemente des transienten Wärmewiderstandes Z_{thCA}
Analytical elements of transient thermal impedance Z_{thCA}

Pos. n	1	2	3	4	5	6	7
R_{thn} [°C/W]	1,6	0,0726	0,0174				
τ_n [s]	1400	30	2				

Verstärkte Kühlung / Forced cooling
3 Module pro Kühlkörper / 3 modules per heatsink
Kühlkörper / Heatsink type: KM17 (Papst 4650N)

Analytische Elemente des transienten Wärmewiderstandes Z_{thCA}
Analytical elements of transient thermal impedance Z_{thCA}

Pos. n	1	2	3	4	5	6	7
R_{thn} [°C/W]	0,475	0,08	0,015				
τ_n [s]	458	40,4	4,11				

Analytische Funktion / Analytical function:
$$Z_{thCA} = \sum_{n=1}^{n_{max}} R_{thn} \left(1 - e^{-\frac{t}{\tau_n}} \right)$$

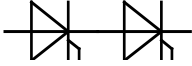

Netz-Thyristor-Modul
Phase Control Thyristor Module

TT250N

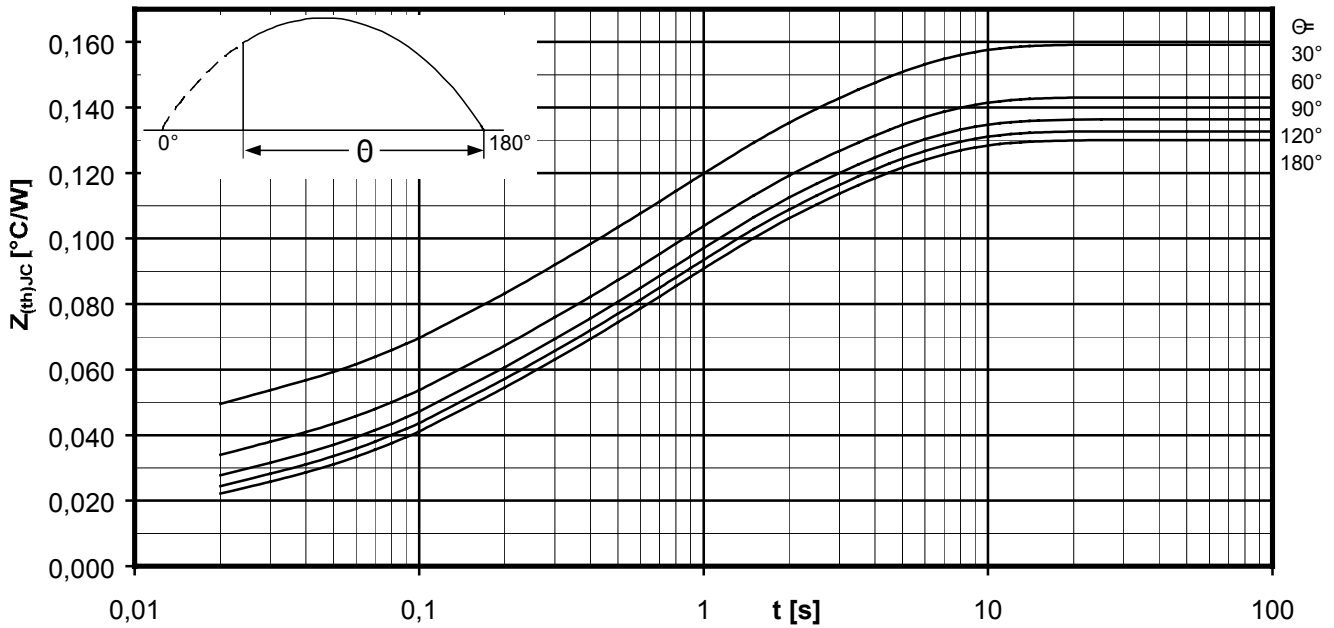

Transienter innerer Wärmewiderstand je Zweig / Transient thermal impedance per arm $Z_{thJC} = f(t)$

Sinusförmiger Strom / Sinusoidal current

Parameter: Stromflußwinkel Θ / Current conduction angle Θ

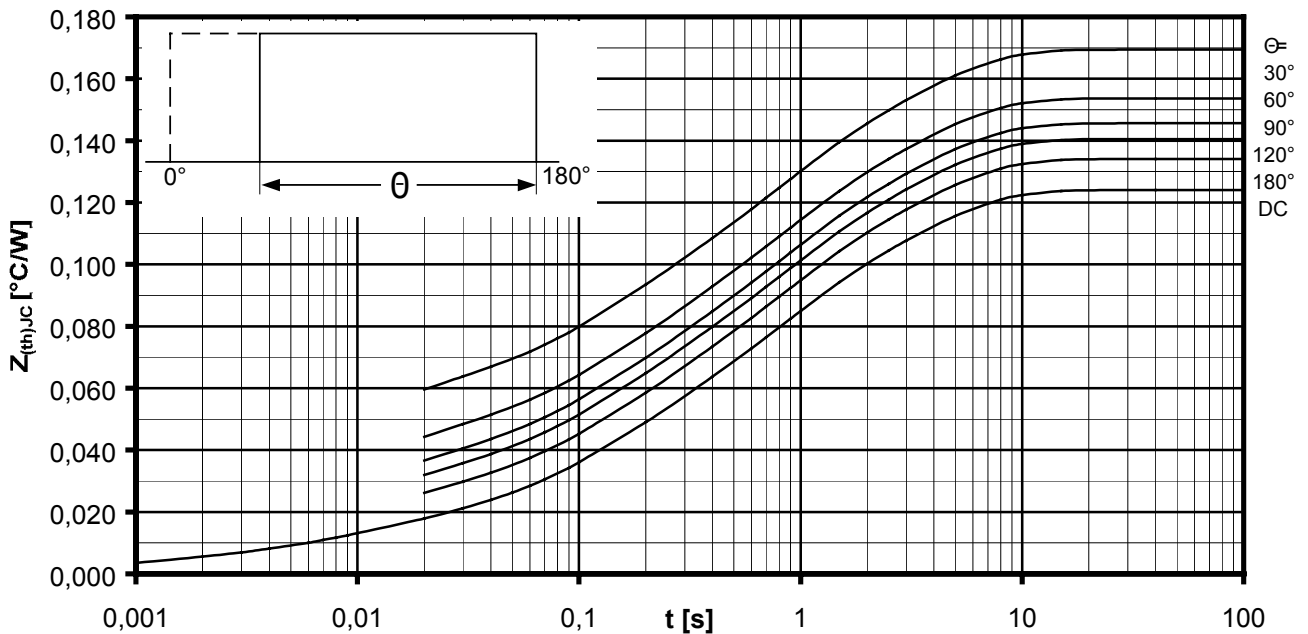

Transienter innerer Wärmewiderstand je Zweig / Transient thermal impedance per arm $Z_{thJC} = f(t)$

Rechteckförmiger Strom / Rectangular current

Parameter: Stromflußwinkel Θ / Current conduction angle Θ



Netz-Thyristor-Modul
Phase Control Thyristor Module

TT250N

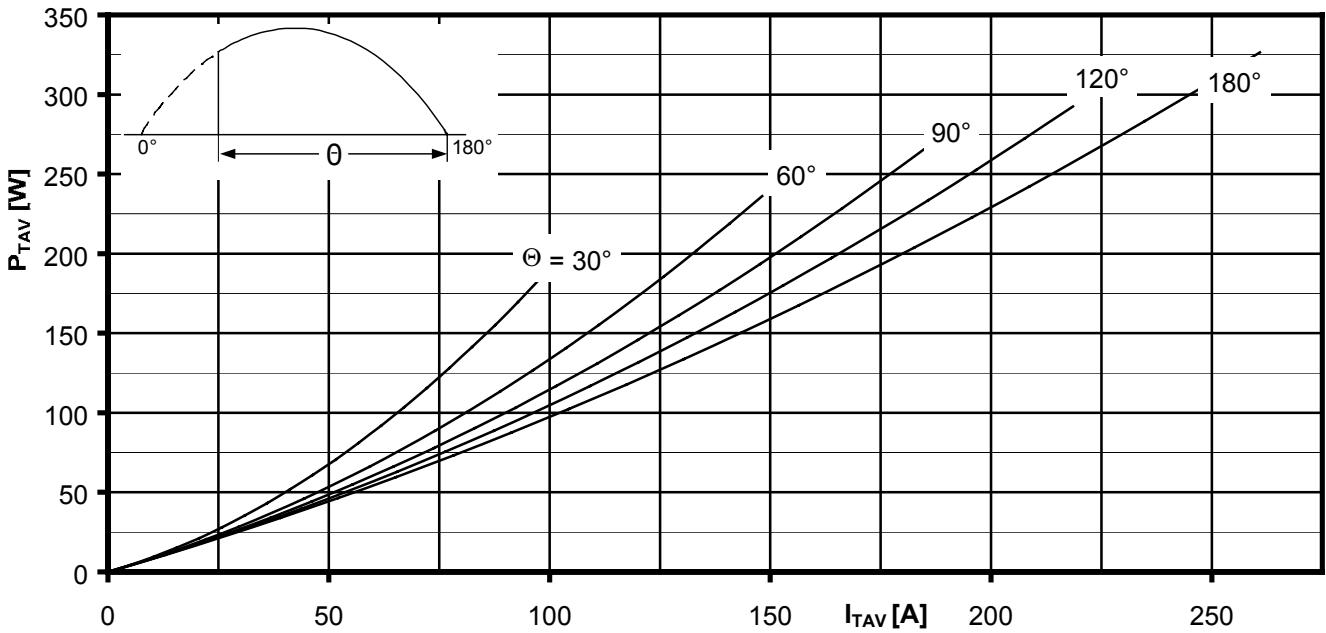

Durchlassverlustleistung je Zweig / On-state power loss per arm $P_{TAV} = f(I_{TAV})$

Sinusförmiger Strom / Sinusoidal current Strombelastung je Zweig / Current load per arm

Berechnungsgrundlage P_{TAV} (Schaltverluste gesondert berücksichtigen)
Calculation base P_{TAV} (switching losses should be considered separately)

Parameter: Stromflußwinkel / Current conduction angle Θ

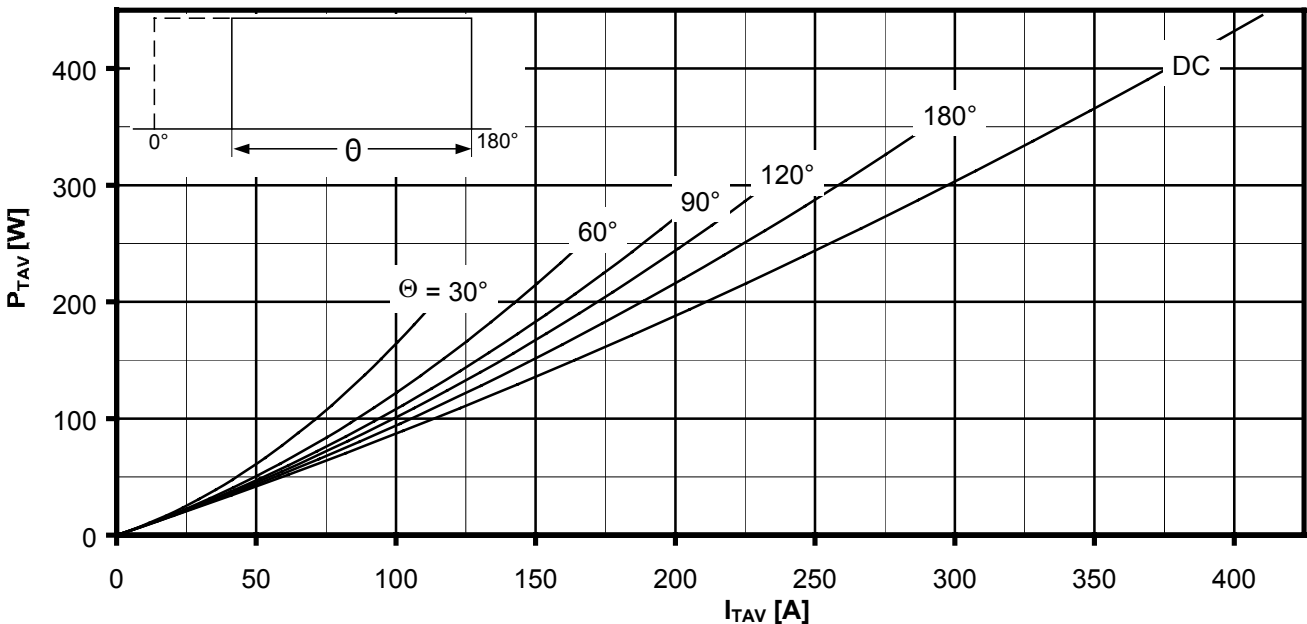

Durchlassverlustleistung je Zweig / On-state power loss per arm $P_{TAV} = f(I_{TAV})$

Rechteckförmiger Strom / Rectangular current Strombelastung je Zweig / Current load per arm

Berechnungsgrundlage P_{TAV} (Schaltverluste gesondert berücksichtigen)
Calculation base P_{TAV} (switching losses should be considered separately)

Parameter: Stromflußwinkel / Current conduction angle Θ



Netz-Thyristor-Modul
Phase Control Thyristor Module

TT250N

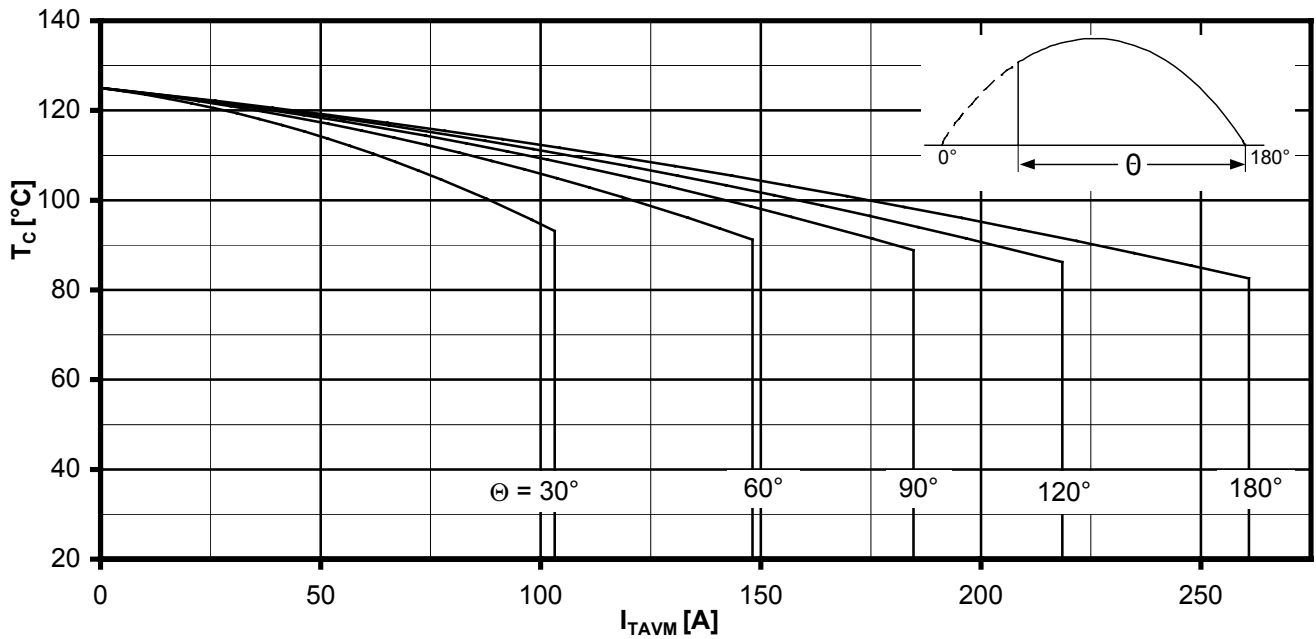

Höchstzulässige Gehäusetemperatur / Maximum allowable case temperature $T_c = f(I_{TAVM})$

Sinusförmiger Strom / Sinusoidal current Strombelastung je Zweig / Current load per arm

Berechnungsgrundlage P_{TAV} (Schaltverluste gesondert berücksichtigen)
Calculation base P_{TAV} (switching losses should be considered separately)

Parameter: Stromflußwinkel Θ / Current conduction angle Θ

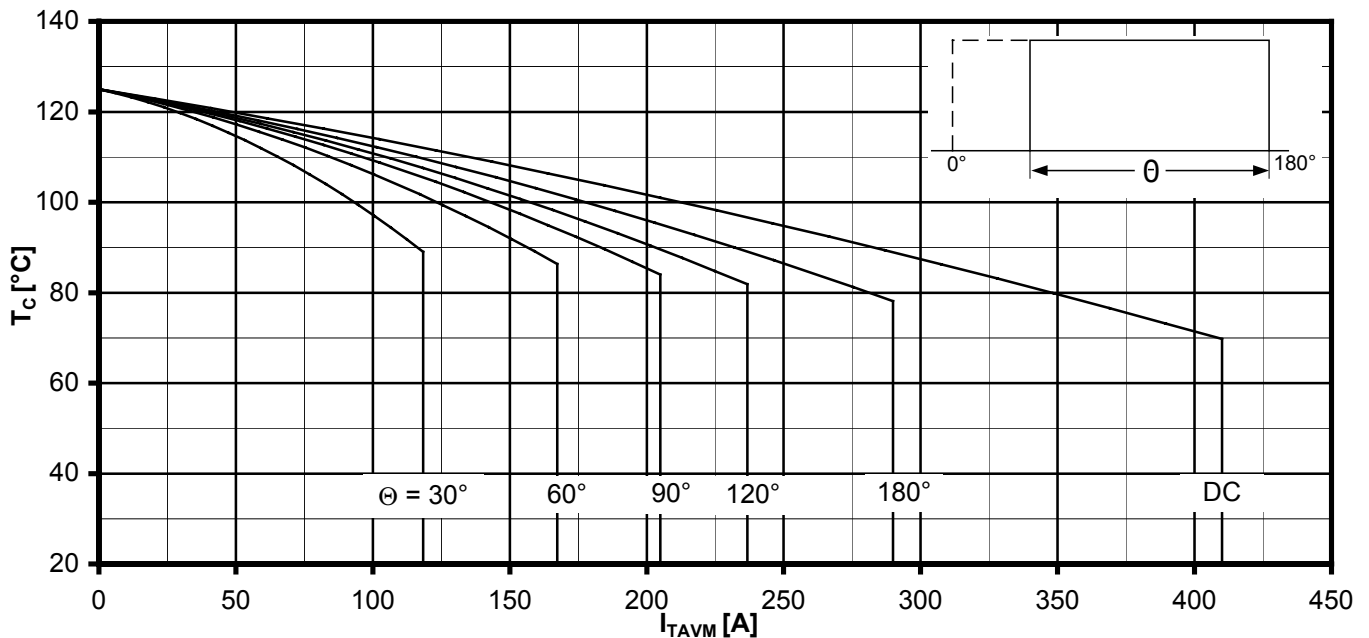

Höchstzulässige Gehäusetemperatur / Maximum allowable case temperature $T_c = f(I_{TAVM})$

Rechteckförmiger Strom / Rectangular current Strombelastung je Zweig / Current load per arm

Berechnungsgrundlage P_{TAV} (Schaltverluste gesondert berücksichtigen)
Calculation base P_{TAV} (switching losses should be considered separately)

Parameter: Stromflußwinkel Θ / Current conduction angle Θ



Netz-Thyristor-Modul
Phase Control Thyristor Module

TT250N

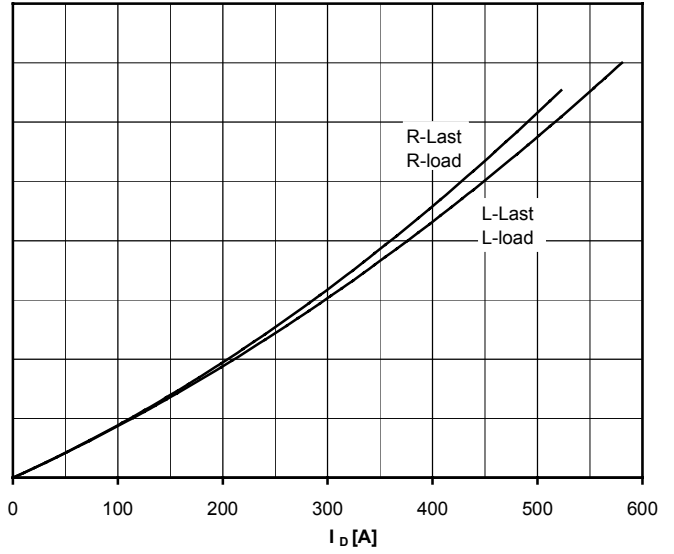
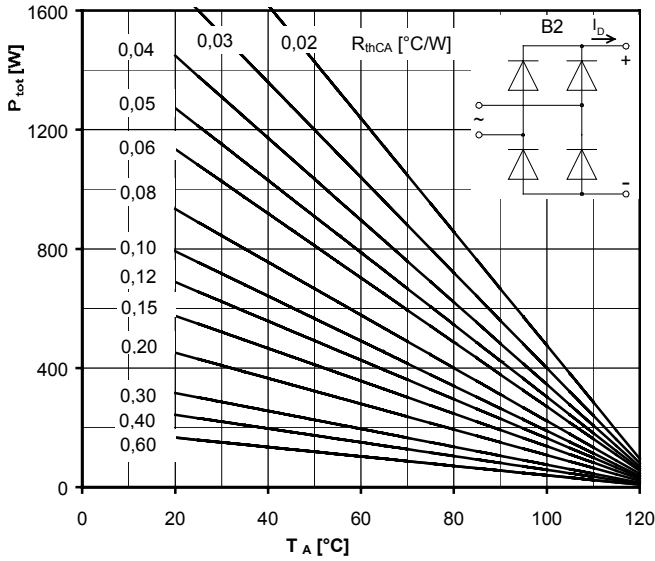

Höchstzulässiger Ausgangsstrom / Maximum rated output current I_D

B2- Zweipuls-Brückenschaltung / Two-pulse bridge circuit

Gesamtverlustleistung der Schaltung / Total power dissipation at circuit P_{tot}

Parameter:

Wärmewiderstand zwischen den Gehäusen und Umgebung / Thermal resistance cases to ambient R_{thCA}

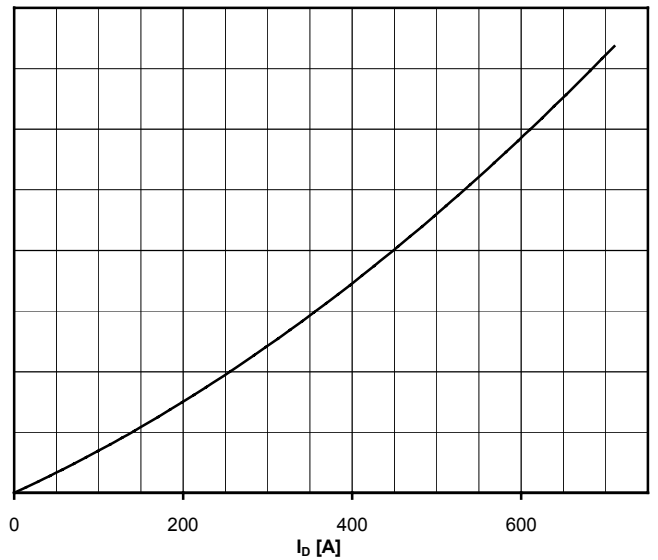
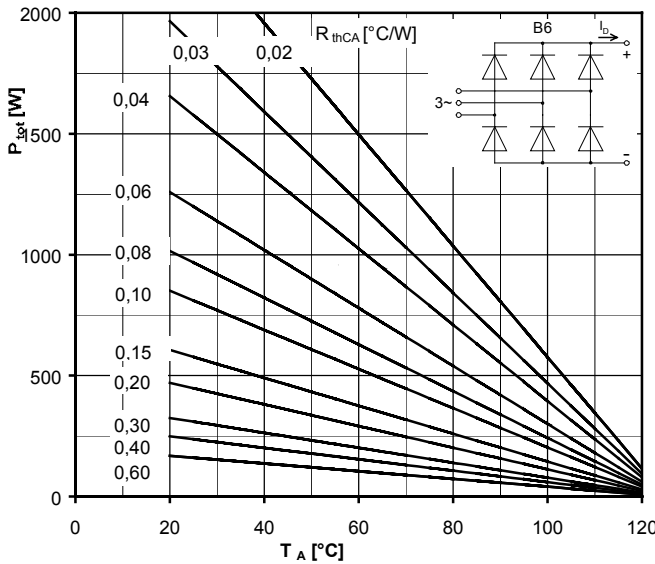

Höchstzulässiger Ausgangsstrom / Maximum rated output current I_D

B6- Sechspuls-Brückenschaltung / Six-pulse bridge circuit

Gesamtverlustleistung der Schaltung / Total power dissipation at circuit P_{tot}

Parameter:

Wärmewiderstand zwischen den Gehäusen und Umgebung / Thermal resistance cases to ambient R_{thCA}



Netz-Thyristor-Modul
Phase Control Thyristor Module

TT250N

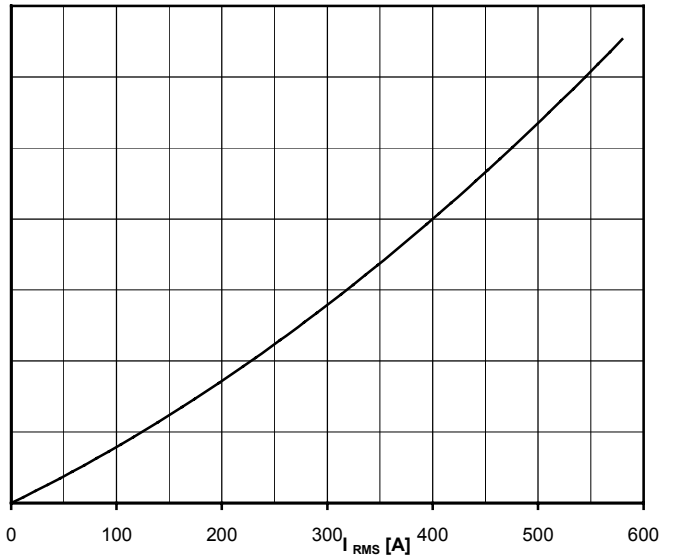
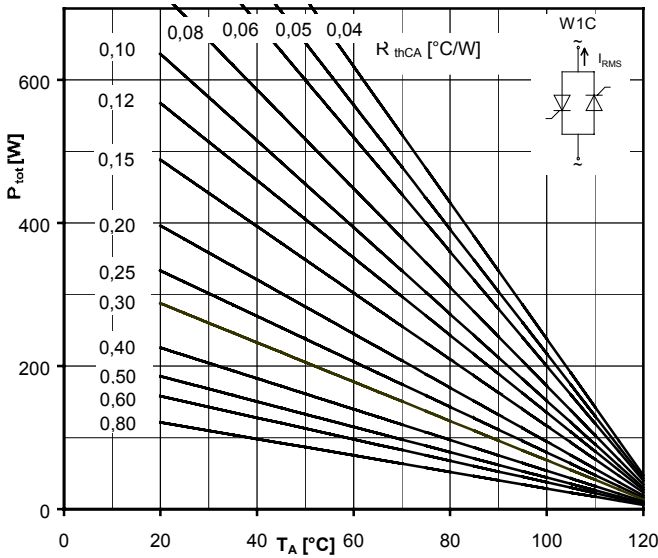

Höchstzulässiger Effektivstrom / Maximum rated RMS current I_{RMS}

W1C - Einphasen-Wechselwegschaltung / Single-phase inverse parallel circuit

Gesamtverlustleistung der Schaltung / Total power dissipation at circuit P_{tot}

Parameter:

Wärmewiderstand zwischen den Gehäusen und Umgebung / Thermal resistance case to ambient R_{thCA}

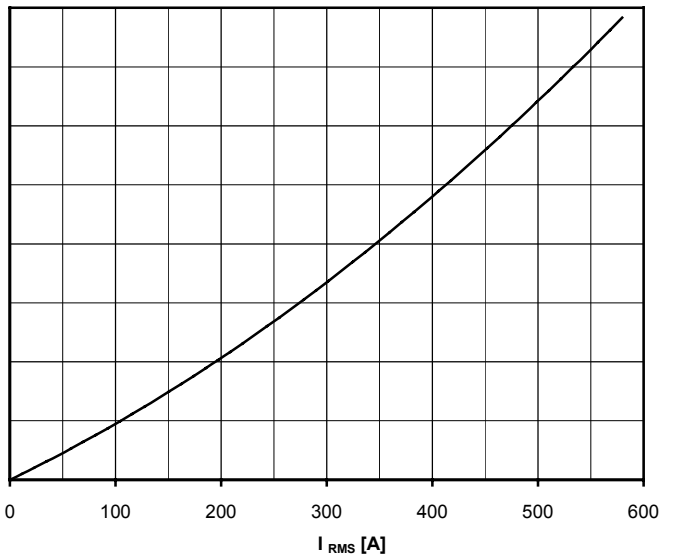
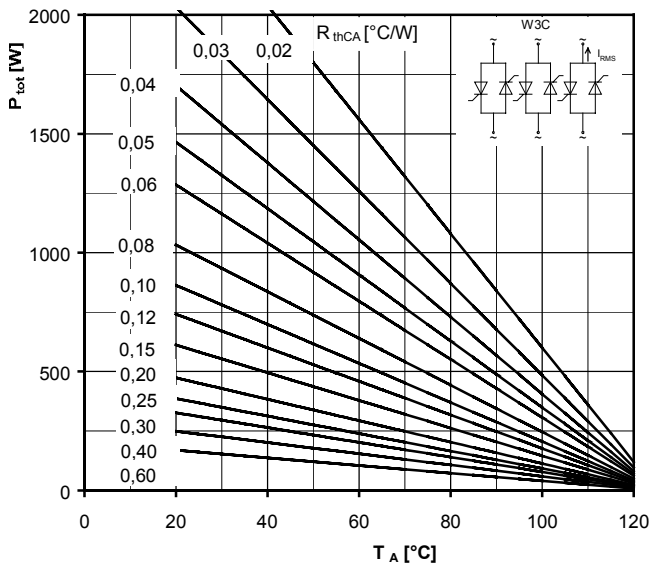

Höchstzulässiger Effektivstrom / Maximum rated RMS current I_{RMS}

W3C - Dreiphasen-Wechselwegschaltung / Three-phase inverse parallel circuit

Gesamtverlustleistung der Schaltung / Total power dissipation at circuit P_{tot}

Parameter:

Wärmewiderstand zwischen den Gehäusen und Umgebung / Thermal resistance cases to ambient R_{thCA}



Netz-Thyristor-Modul
Phase Control Thyristor Module

TT250N

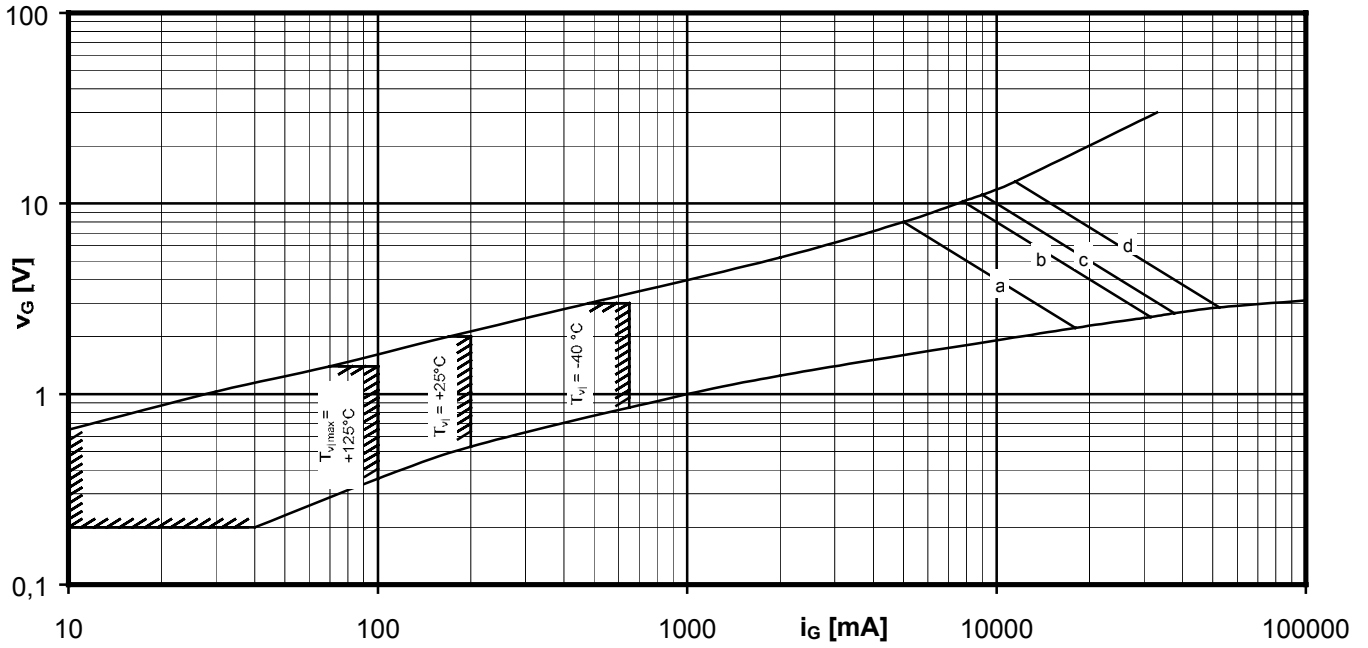

Steuercharakteristik $v_G = f(i_G)$ mit Zündbereichen für $V_D = 6 V$
Gate characteristic $v_G = f(i_G)$ with triggering area for $V_D = 6 V$

Höchstzulässige Spitzensteuerverlustleistung / Maximum rated peak gate power dissipation $P_{GM} = f(t_g)$:

a - 40 W/10ms b - 80 W/1ms c - 100 W/0,5ms d - 150W/0,1ms

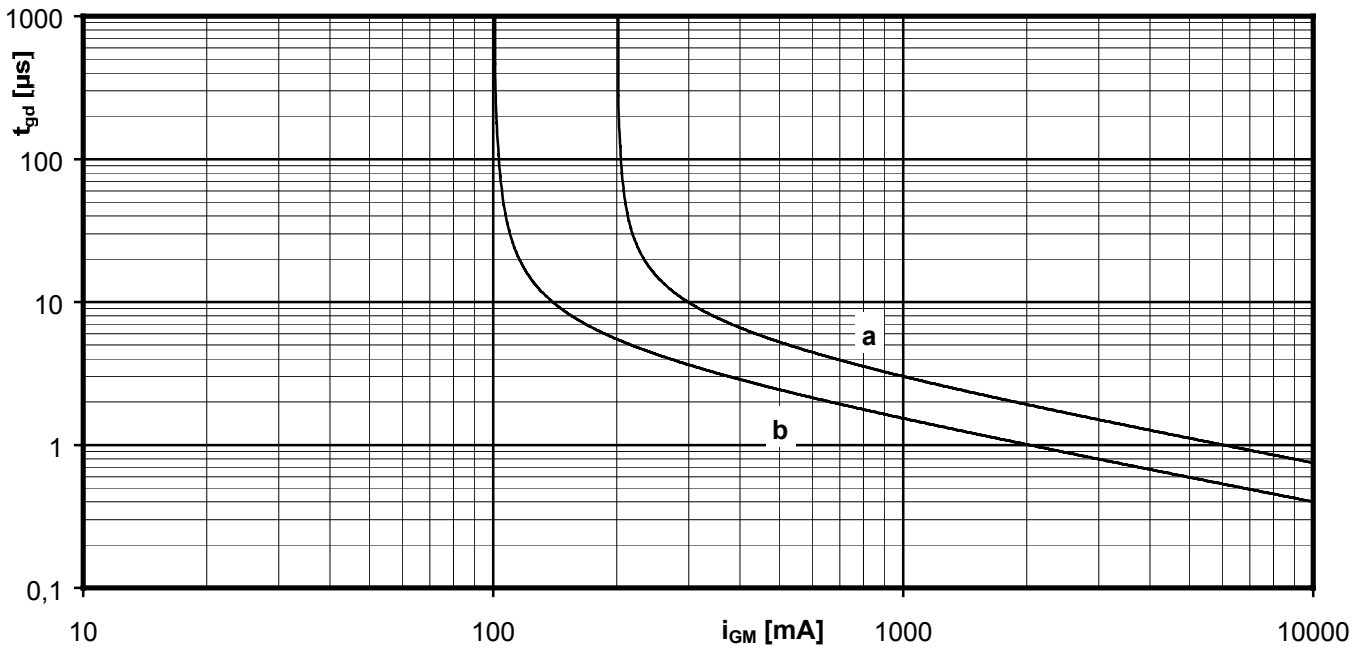

Zündverzug / Gate controlled delay time $t_{gd} = f(i_G)$

$T_{vj} = 25^\circ C, di_G/dt = i_{GM}/1\mu s$

a - maximaler Verlauf / Limiting characteristic

b - typischer Verlauf / Typical characteristic



Netz-Thyristor-Modul
Phase Control Thyristor Module

TT250N

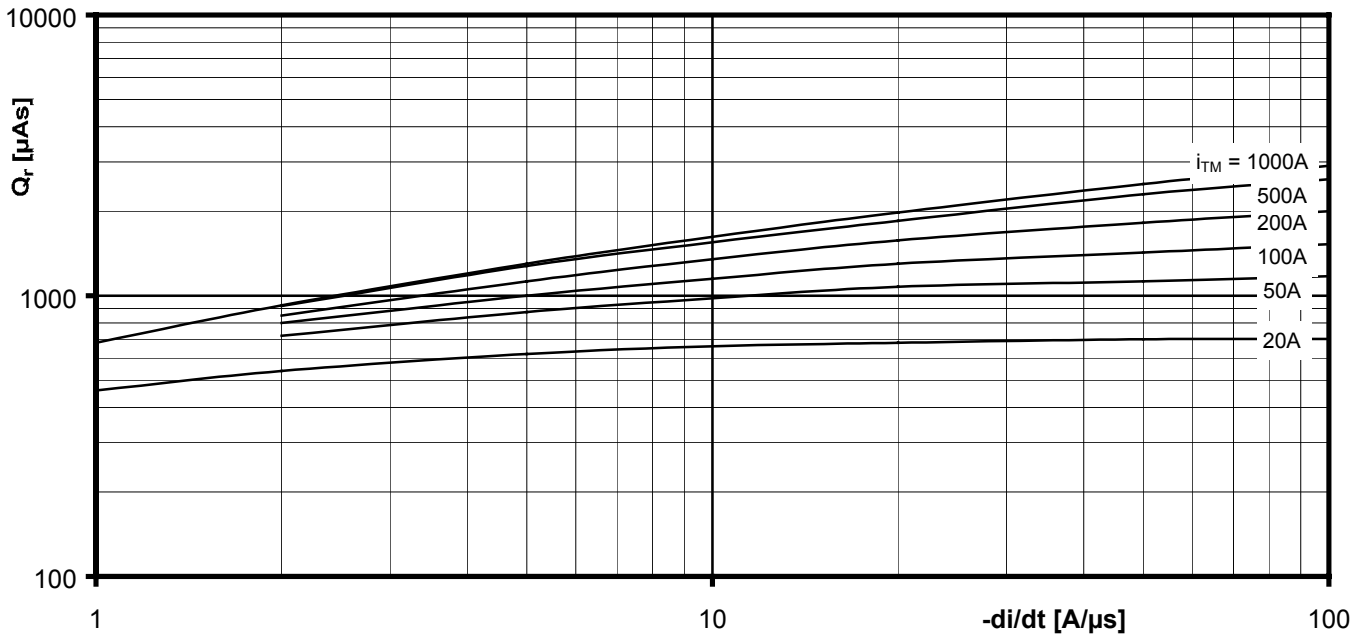

Sperrverzögerungsladung / Recovered charge $Q_r = f(-di/dt)$

$$T_{vj} = T_{vjmax}, V_R \leq 0,5 V_{RRM}, V_{RM} = 0,8 V_{RRM}$$

Parameter: Durchlaßstrom / On-state current i_{TM}

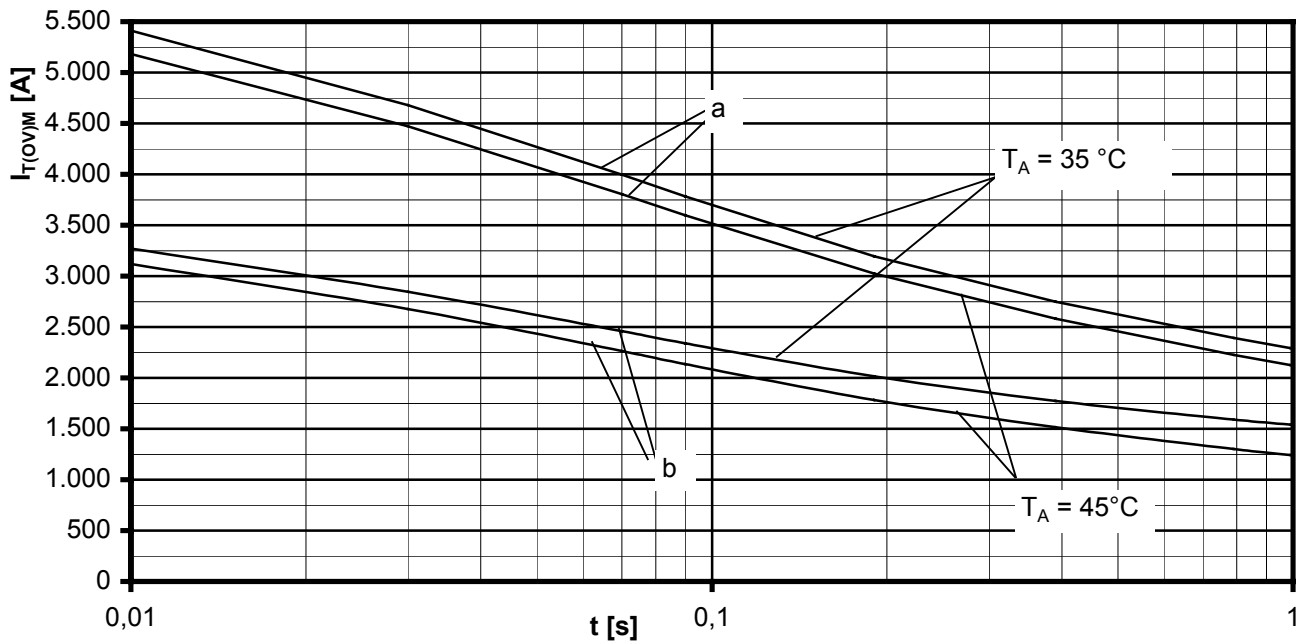

Grenzstrom / Maximum overload on-state current $I_{T(OV)M} = f(t), V_{RM} = 0,8 V_{RRM}$

- a: Leerlauf / No-load conditions
- b: nach Belastung mit I_{TAVM} / after load with I_{TAVM}
- $T_A = 35^\circ C$, verstärkte Luftkühlung / Forced air cooling
- $T_A = 45^\circ C$, Luftselbstkühlung / Natural air cooling



Netz-Thyristor-Modul
Phase Control Thyristor Module

TT250N

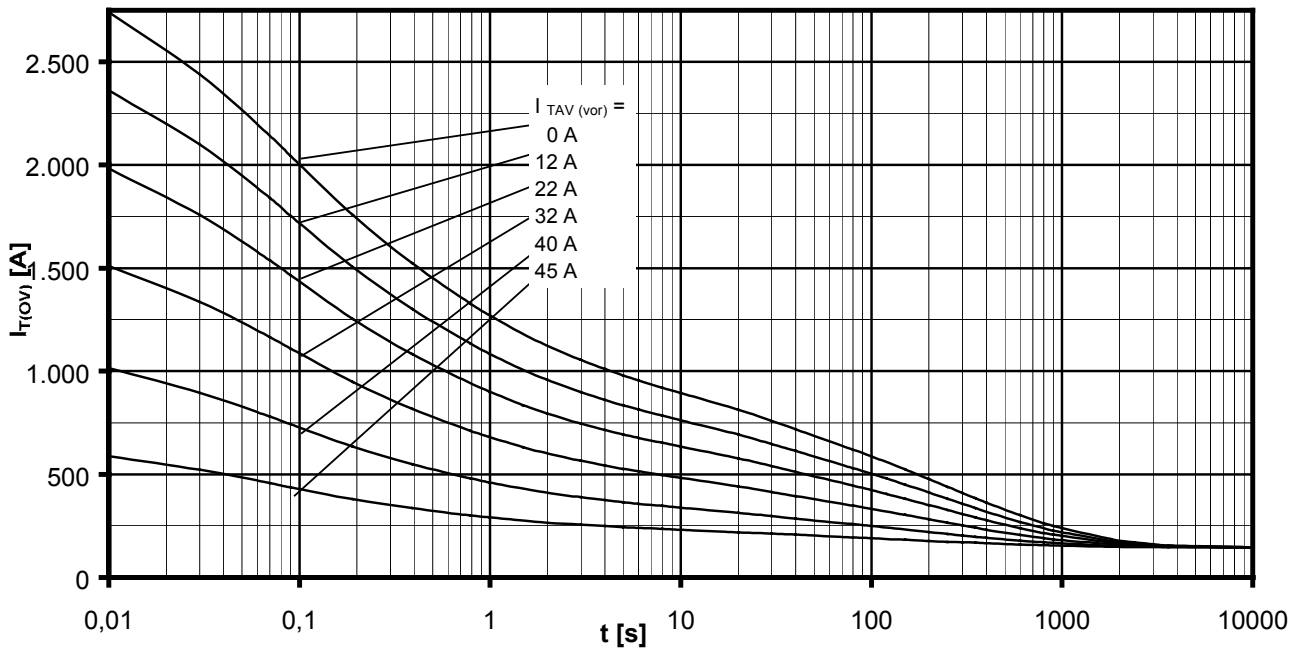

Überstrom je Zweig / Overload on-state current $I_{T(OV)}$

B6- Sechspuls-Brückenschaltung, 120° Rechteck / Six-pulse bridge circuit, 120° rectangular

Kühlkörper / Heatsink type KM17 (45W) Luftselbstkühlung bei / Natural cooling at $T_A = 45^\circ\text{C}$

Parameter: Vorlaststrom je Zweig / Pre-load current per arm $I_{TAV(vor)}$

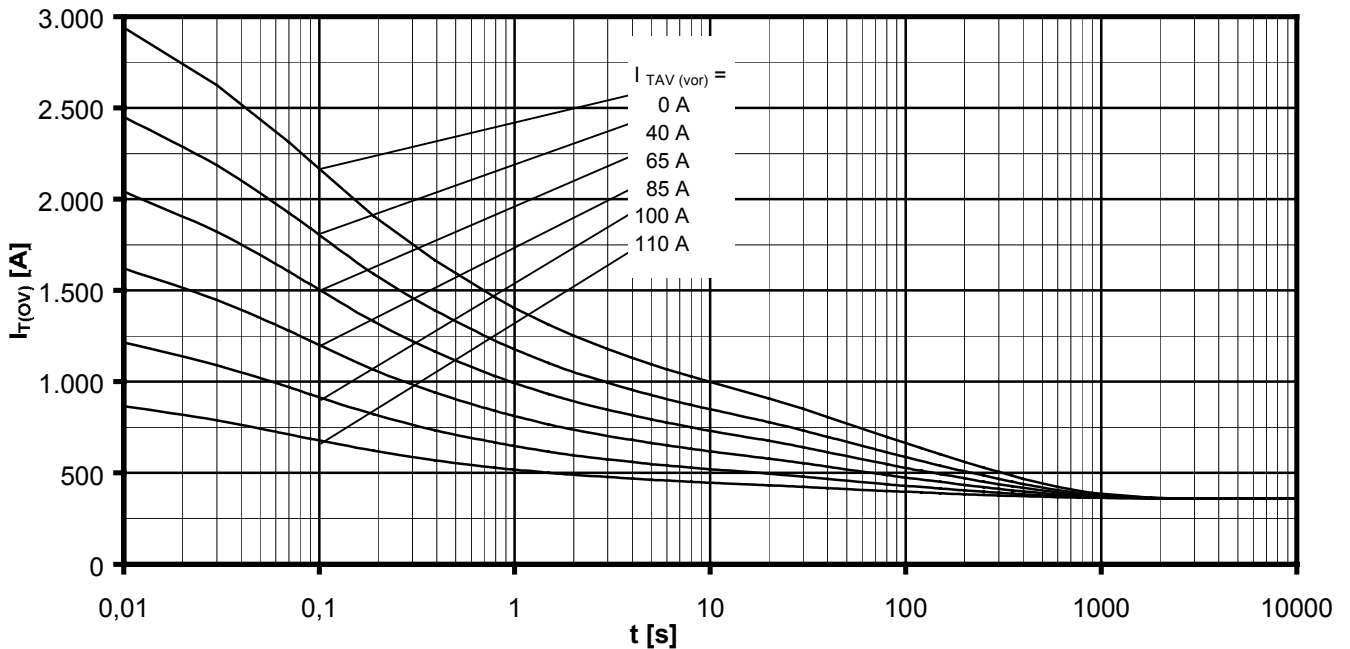

Überstrom je Zweig / Overload on-state current $I_{T(OV)}$

B6- Sechspuls-Brückenschaltung, 120° Rechteck / Six-pulse bridge circuit, 120° rectangular

Kühlkörper / Heatsink type KM17 (Papst 4650N) Verstärkte Kühlung bei / Forced cooling at $T_A = 35^\circ\text{C}$

Parameter: Vorlaststrom je Zweig / Pre-load current per arm $I_{TAV(vor)}$