

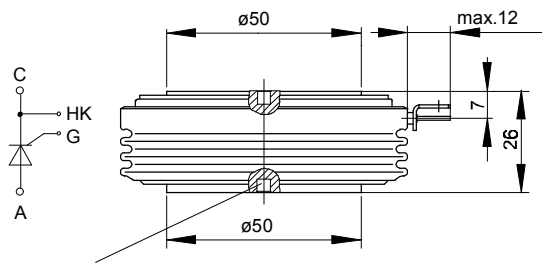

European Power-Semiconductor and Electronics Company

Marketing Information

T 1500 N



$\varnothing 3,5 \times 3,5$ deep
on both sides

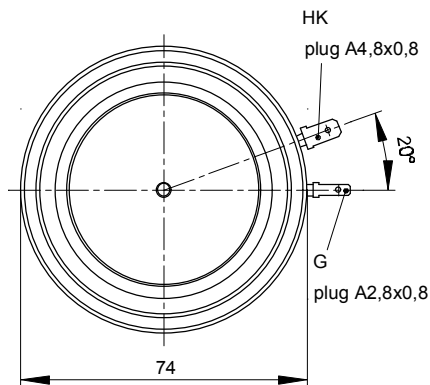

T 1509 N

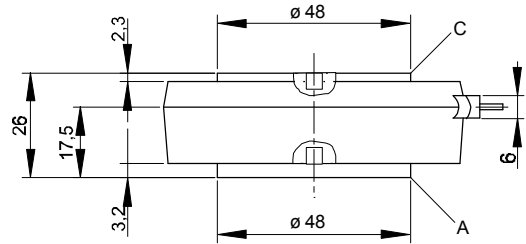

$3,5^{+0,1} \times 3,5$ deep
on both sides

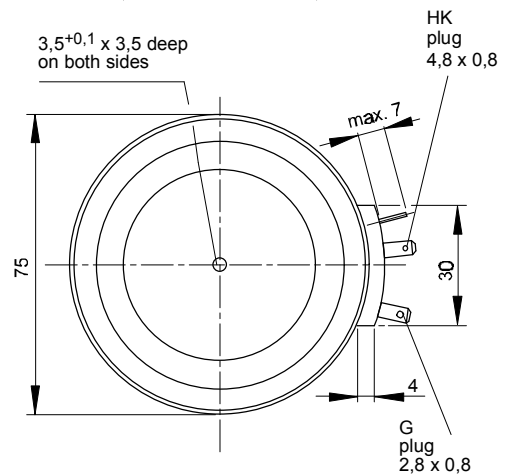

T 1500 N T 1509 N

Elektrische Eigenschaften

Höchstzulässige Werte

Periodische Vorwärts- und Rückwärts-Spitzensperrspannung

Electrical properties

Maximum rated values

repetitive peak forward off-state and reverse voltages

Vorwärts-Stoßspitzensperrspannung

non-repetitive peak forward off-state voltage

Rückwärts-Stoßspitzensperrspannung

non-repetitive peak reverse voltage

Durchlaßstrom-Grenzeffektivwert

RMS on-state current

Dauergrenzstrom

average on-state current

Stoßstrom-Grenzwert

surge current

Grenzlastintegral

$I^2 t$ -value

Kritische Stromsteilheit

critical rate of rise of on-state current

Kritische Spannungssteilheit

critical rate of rise of off-state voltage

$t_{vj} = -40^\circ\text{C} \dots t_{vj \max}$	$V_{\text{DRM}}, V_{\text{RRM}}$	1200 1400 1600 1800	V
$t_{vj} = -40^\circ\text{C} \dots t_{vj \max}$	$V_{\text{DSM}} = V_{\text{DRM}}$	1200 1400 1600 1800	V
$t_{vj} = +25^\circ\text{C} \dots t_{vj \max}$	$V_{\text{RSM}} = V_{\text{RRM}}$	1300 1500 1700 1900	V
$t_c = 85^\circ\text{C}$	I_{TRMSM}	3500	A
$t_c = 54^\circ\text{C}$	I_{TAVM}	1500	A
$t_{vj} = 25^\circ\text{C}, t_p = 10 \text{ ms}$	I_{TSM}	35000	A
$t_{vj} = t_{vj \max}, t_p = 10 \text{ ms}$		30000	A
$t_{vj} = 25^\circ\text{C}, t_p = 10 \text{ ms}$	$I^2 t$	$6,12 \cdot 10^6$	A^2s
$t_{vj} = t_{vj \max}, t_p = 10 \text{ ms}$		$4,5 \cdot 10^6$	A^2s
$v_D \leq 67\%, V_{\text{DRM}}, f = 50 \text{ Hz}$	$(di_T/dt)_{\text{cr}}$	200	$\text{A}/\mu\text{s}$
$i_{\text{GM}} = 1 \text{ A}, di_G/dt = 1 \text{ A}/\mu\text{s}$			
$t_{vj} = t_{vj \max}, v_D = 0,67\% V_{\text{DRM}}$	$(dv/dt)_{\text{cr}}$		
5.Kennbuchstabe/5th letter C		500	$\text{V}/\mu\text{s}$
5.Kennbuchstabe/5th letter F		1000	$\text{V}/\mu\text{s}$

Charakteristische Werte

Durchlaßspannung

Characteristic values

on-state voltage

Schleusenspannung

threshold voltage

Ersatzwiderstand

slope resistance

Zündstrom

gate trigger current

Zündspannung

gate trigger voltage

Nicht zündender Steuerstrom

gate non-trigger current

Nicht zündender Steuerspannung

gate non-trigger voltage

Haltestrom

holding current

Einraststrom

latching current

Vorwärts- und Rückwärts-Sperrstrom

forward off-state and reverse currents

Zündverzögerung

gate controlled delay time

Freiwerdzeit

circuit commutated turn-off time

$t_{vj} = t_{vj \max}, i_T = 7000 \text{ A}$	v_T	max. 2,1	V
$t_{vj} = t_{vj \max}$	$V_{\text{T(TO)}}$	0,9	V
$t_{vj} = t_{vj \max}$	r_T	0,15	$\text{m}\Omega$
$t_{vj} = 25^\circ\text{C}, v_D = 6 \text{ V}$	I_{GT}	max. 250	mA
$t_{vj} = 25^\circ\text{C}, v_D = 6 \text{ V}$	V_{GT}	max. 2	V
$t_{vj} = t_{vj \max}, v_D = 6 \text{ V}$	I_{GD}	max. 20	mA
$t_{vj} = t_{vj \max}, v_D = 0,5 V_{\text{DRM}}$		max. 10	mA
$t_{vj} = t_{vj \max}, v_D = 0,5 V_{\text{DRM}}$	V_{GD}	max. 0,2	V
$t_{vj} = 25^\circ\text{C}, v_D = 6 \text{ V}, R_A = 2 \Omega$	I_{H}	max. 500	mA
$t_{vj} = 25^\circ\text{C}, v_D = 6 \text{ V}, R_{\text{GK}} \geq 10 \Omega$	I_{L}	max. 2500	mA
$i_{\text{GM}} = 1 \text{ A}, di_G/dt = 1 \text{ A}/\mu\text{s}, t_g = 20 \mu\text{s}$			
$t_{vj} = t_{vj \max}, v_D = V_{\text{DRM}}, v_R = V_{\text{RRM}}$	i_D, i_R	max. 150	mA
$t_{vj} = 25^\circ\text{C}, i_{\text{GM}} = 1 \text{ A}, di_G/dt = 1 \text{ A}/\mu\text{s}$	t_{gd}	max. 4	μs
siehe Techn.Erl./see Techn. Inf.	t_q	typ. 240	μs

Thermische Eigenschaften

Innerer Wärmewiderstand für beidseitige Kühlung

Thermal properties

thermal resistance, junction to case for two-sided cooling

für anodenseitige Kühlung

for anode-sided cooling

für kathodenseitige Kühlung

for cathode-sided cooling

Übergangs-Wärmewiderstand

thermal resistance, case to heatsink

Höchstzul. Sperrschichttemperatur

max. junction temperature

Betriebstemperatur

operating temperature

Lagertemperatur

storage temperature

$\Theta = 180^\circ \text{ el, sin}$	R_{thJC}	max. 0,0184	$^\circ\text{C}/\text{W}$
DC		max. 0,0170	$^\circ\text{C}/\text{W}$
$\Theta = 180^\circ \text{ el, sin}$	$R_{\text{thJC(A)}}$	max. 0,0344	$^\circ\text{C}/\text{W}$
DC		max. 0,0330	$^\circ\text{C}/\text{W}$
$\Theta = 180^\circ \text{ el, sin}$	$R_{\text{thJC(K)}}$	max. 0,0364	$^\circ\text{C}/\text{W}$
DC		max. 0,0350	$^\circ\text{C}/\text{W}$
beidseitig/two-sided	R_{thCK}	max. 0,0025	$^\circ\text{C}/\text{W}$
einseitig/one-sided		max. 0,0050	$^\circ\text{C}/\text{W}$
$t_{vj \max}$		125	$^\circ\text{C}$
$t_{c \text{ op}}$		-40...+125	$^\circ\text{C}$
t_{stg}		-40...+150	$^\circ\text{C}$

Mechanische Eigenschaften

Si-Elemente mit Druckkontakt

Mechanical properties

Si-pellet with pressure contact

Anpreßkraft

clamping force

Gewicht

weight

Kriechstrecke

creepage distance

Feuchteklasse

humidity classification

Schwingfestigkeit

vibration resistance

Maßbild, anliegend

outline, attached

Durchmesser/diameter 58 mm	F	24...56	kN
T 1500 N/T 1509 N	G	typ. 600/540	g
T 1500 N/T 1509 N		30/32	mm
DIN 40040			C
f = 50 Hz		50	m/s^2
DIN 41814-155B4			



Bild / Fig. 1
Grenzdurchlaßkennlinie / Limiting on-state characteristic
 $i_T = f(v_T), t_{vj} = t_{vj \max}$



Bild / Fig. 2
Durchlaßverlustleistung / On-state power loss $P_{TAV} = f(I_{TAV})$
Parameter: Stromflußwinkel / Current conduction angle θ

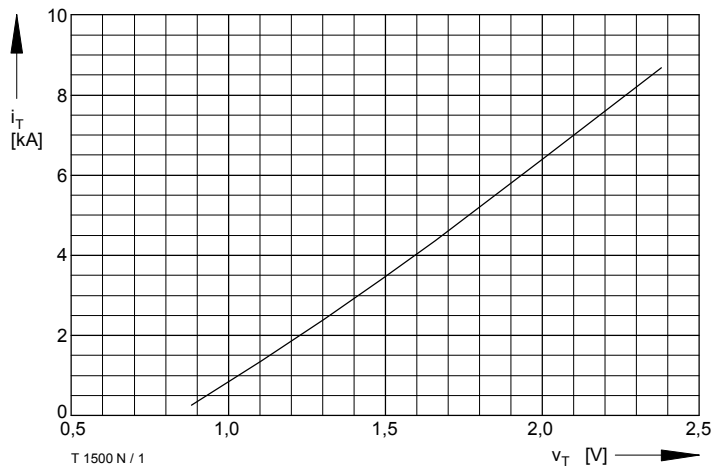

Bild / Fig. 3
Höchstzulässige Gehäusetemperatur / Max. allowable case temperature
 $t_C = f(I_{TAVM})$
Beidseitige Kühlung / Two-sided cooling
Parameter: Stromflußwinkel / Current conduction angle θ

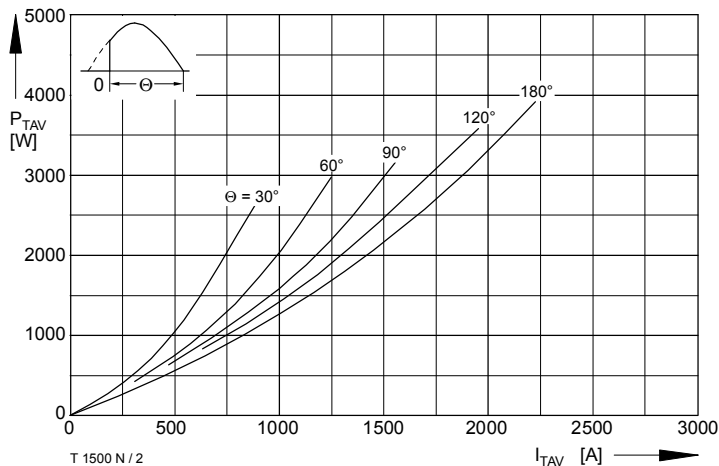

Bild / Fig. 4
Höchstzulässige Gehäusetemperatur / Max. allowable case temperature
 $t_C = f(I_{TAVM})$
Anodenseitige Kühlung / Anode-sided cooling
Parameter: Stromflußwinkel / Current conduction angle θ

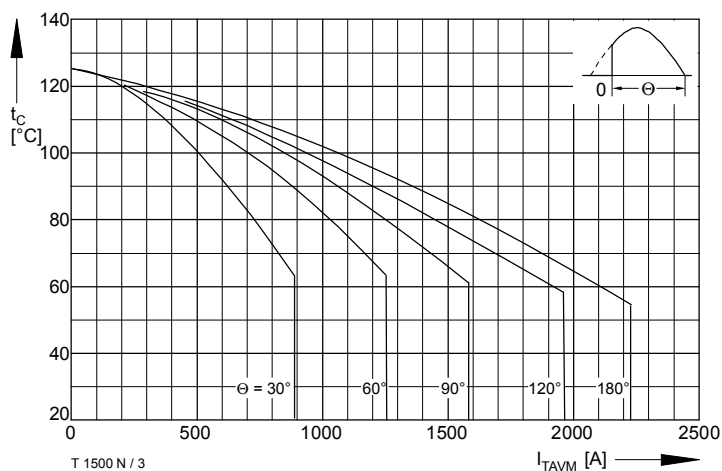

Bild / Fig. 5
Höchstzulässige Kühlmitteltemperatur / Max. allowable cooling medium temperature $t_A = f(I_{TAVM})$
Luftselbstkühlung / Natural air-cooling
Kühlkörper / Heatsink: K0.05F
Parameter: Stromflußwinkel / Current conduction angle θ

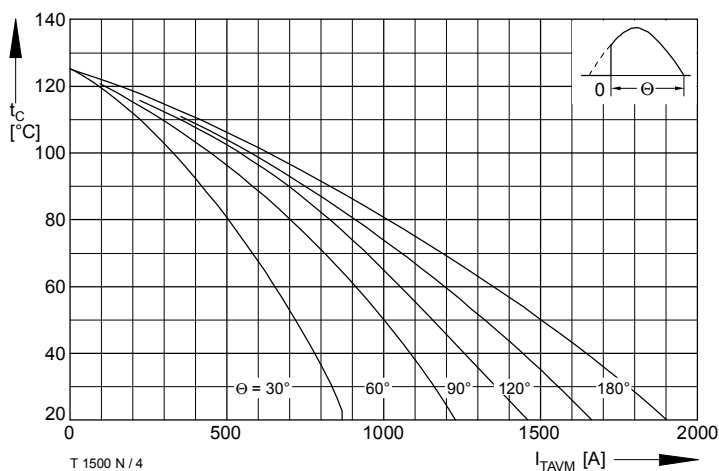

Bild / Fig. 6
Höchstzulässige Kühlmitteltemperatur / Max. allowable cooling medium temperature $t_A = f(I_{TAVM})$
Verstärkte Luftkühlung / Forced air cooling
Kühlkörper / Heatsink: K0.05F, $V_L = 120$ l/s
Parameter: Stromflußwinkel / Current conduction angle θ

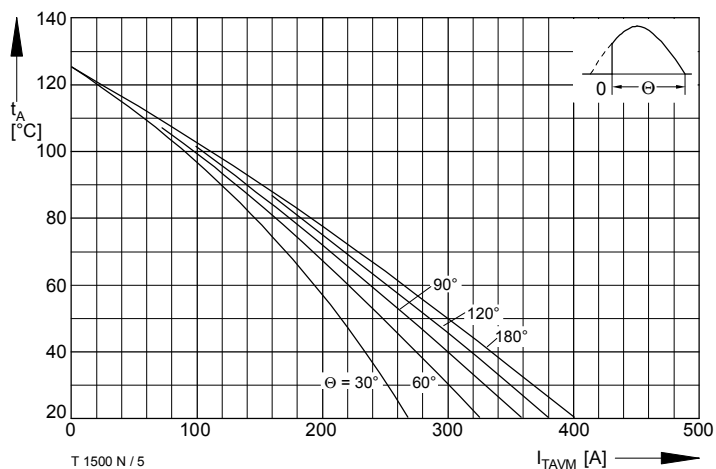

Bild / Fig. 7
Durchlaßverlustleistung / On-state power loss $P_{TAV} = f(I_{TAV})$
Parameter: Stromflußwinkel / Current conduction angle θ

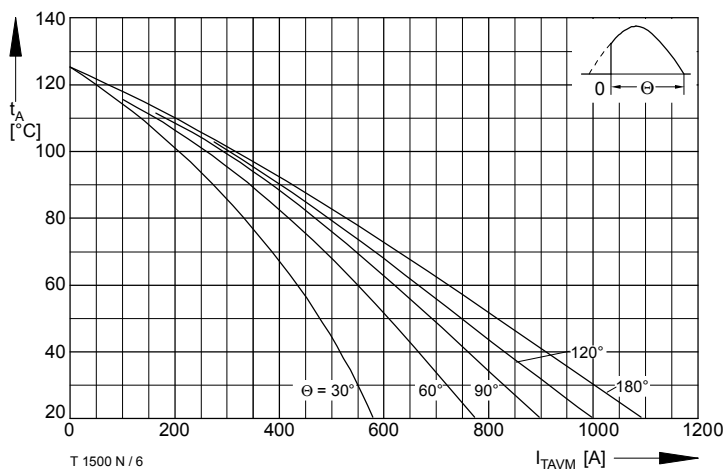

Bild / Fig. 8
Höchstzulässige Gehäusetemperatur / Max. allowable case temperature
 $t_C = f(I_{TAVM})$
Beidseitige Kühlung / Two-sided cooling
Parameter: Stromflußwinkel / Current conduction angle θ

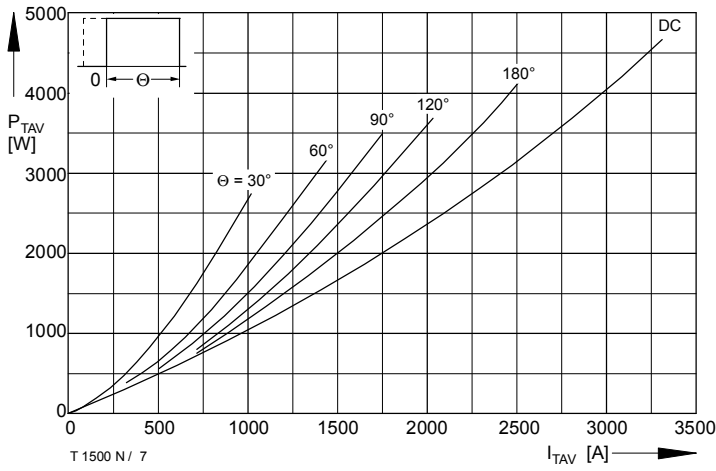

Bild / Fig. 9
Höchstzulässige Gehäusetemperatur / Max. allowable case temperature
 $t_C = f(I_{TAVM})$
Anodenseitige Kühlung / Anode-sided cooling
Parameter: Stromflußwinkel / Current conduction angle θ

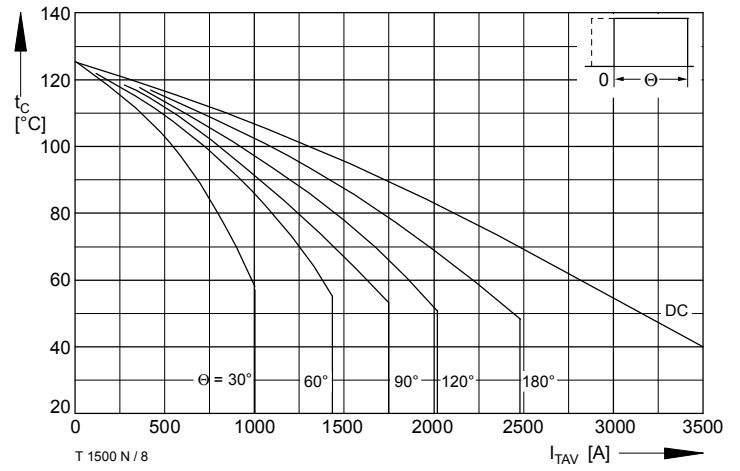

Bild / Fig. 10
Höchstzulässige Kühlmitteltemperatur / Max. allowable cooling medium temperature $t_A = f(I_{TAVM})$
Luftselbstkühlung / Natural air-cooling
Kühlkörper / Heatsink: K0.05F
Parameter: Stromflußwinkel / Current conduction angle θ

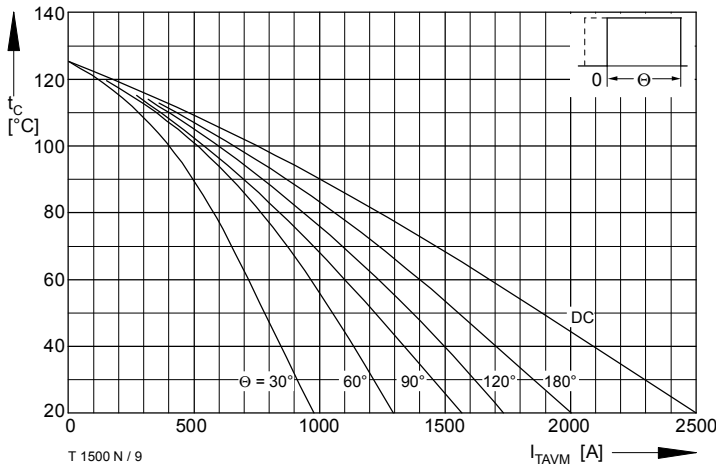

Bild / Fig. 11
Höchstzulässige Kühlmitteltemperatur / Max. allowable cooling medium temperature $t_A = f(I_{TAVM})$
Verstärkte Luftkühlung / forced air cooling
Kühlkörper / Heatsink: K0.05F, $V_L = 120$ l/s
Parameter: Stromflußwinkel / Current conduction angle θ

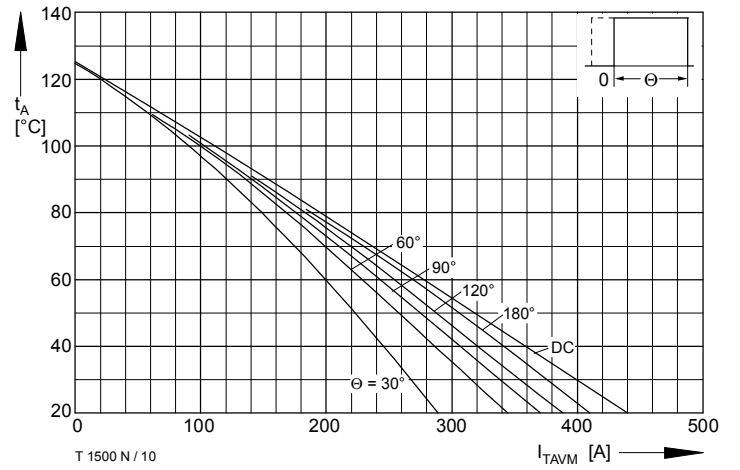

Bild / Fig. 12
Höchstzulässiger Durchlaßstrom bei Aussetzbetrieb / Max. allowable on-state current at intermittent operation $I_{TINT} = f(ED)$
Luftselbstkühlung / Natural air-cooling, $t_A = 45$ °C
Kühlkörper / Heatsink: K0.05F
Parameter: Spieldauer / Cycle duration SD
Vorlaststrom / Pre-load current $I_{TAV(vor)}$

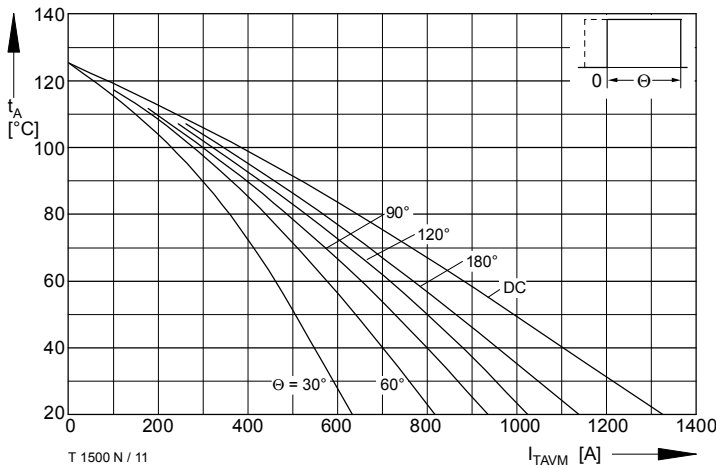

Bild / Fig. 13
 Höchstzulässiger Durchlaßstrom bei Aussetzbetrieb / Max. allowable on-state current at intermittent operation $I_{TINT} = f(ED)$
 Verstärkte Luftkühlung / Forced air-cooling, $t_A = 35^\circ\text{C}$, $V_L = 120 \text{ l/s}$
 Kühlkörper / Heatsink: K0.05F
 Parameter: Spieldauer / Cycle duration SD
 Vorlaststrom / Pre-load current $I_{TAV(vor)}$

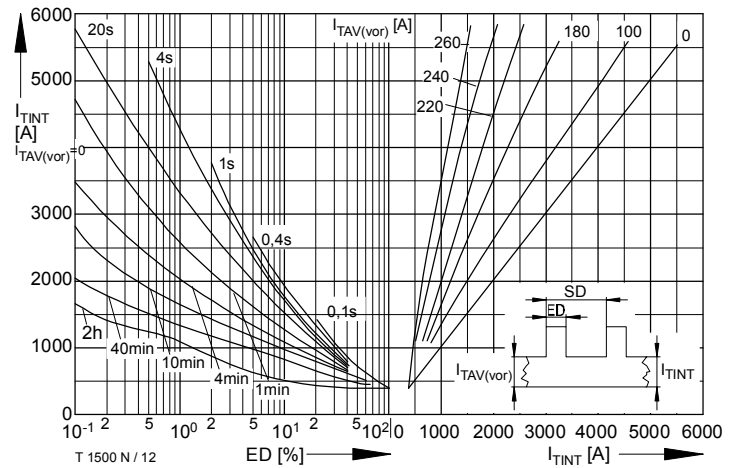

Bild / Fig. 14
 Überstrom / Overload on-state current $I_{T(OV)} = f(t)$
 Luftselbstkühlung / Natural air-cooling, $t_A = 45^\circ\text{C}$
 Kühlkörper / Heatsink: K0.05F
 Parameter: Vorlaststrom / Pre-load current $I_{TAV(vor)}$

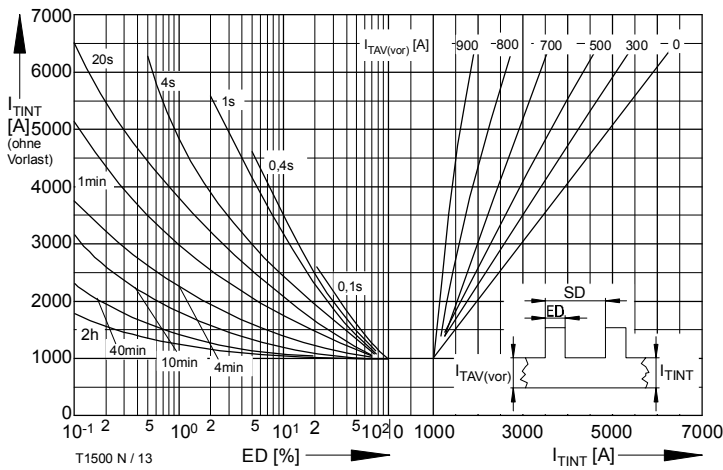

Bild / Fig. 15
 Überstrom / Overload on-state current $I_{T(OV)} = f(t)$
 Verstärkte Luftkühlung / Forced air-cooling, $t_A = 35^\circ\text{C}$
 Kühlkörper / Heatsink: K0.05F, $V_L = 120 \text{ l/s}$
 Parameter: Vorlaststrom / Pre-load current $I_{TAV(vor)}$

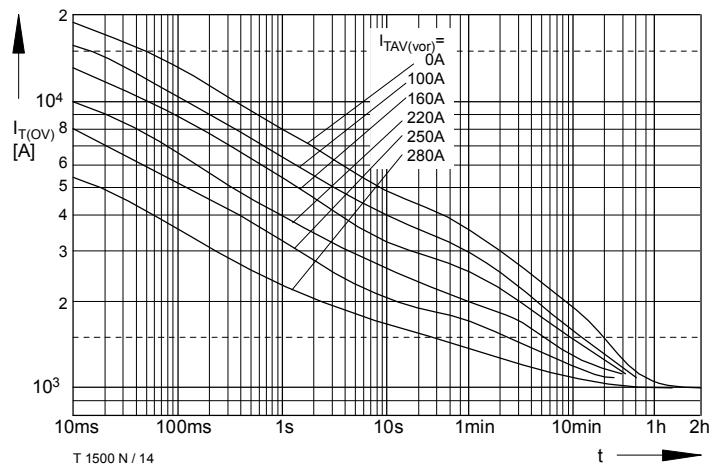

Bild / Fig. 16
 Steuercharakteristik mit Zündbereichen / Gate characteristic with triggering areas $v_G = f(i_G)$, $V_D = 6 \text{ V}$
 Parameter:

	a	b	c
Steuerimpulsdauer / trigger puls duration t_g [ms]	10	1	0,5
Höchstzulässige Spitzensteuerverlustleistung / Max. rated peak gate power dissipation [W]	20	40	60

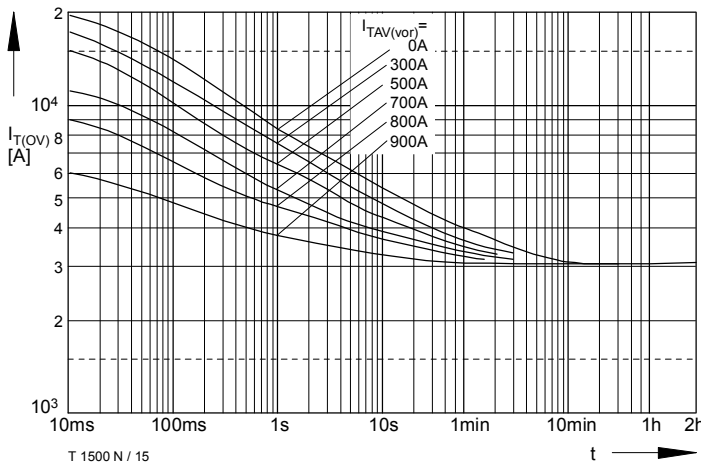

Bild / Fig. 17
 Zündverzug / Gate controlled delay time $t_{gd} = f(i_{GM})$
 $t_{vj} = 25^\circ\text{C}$, $di_G/dt = i_{GM}/1\mu\text{s}$
 a - Maximaler Verlauf / Limiting characteristic
 b - Typischer Verlauf / Typical characteristic

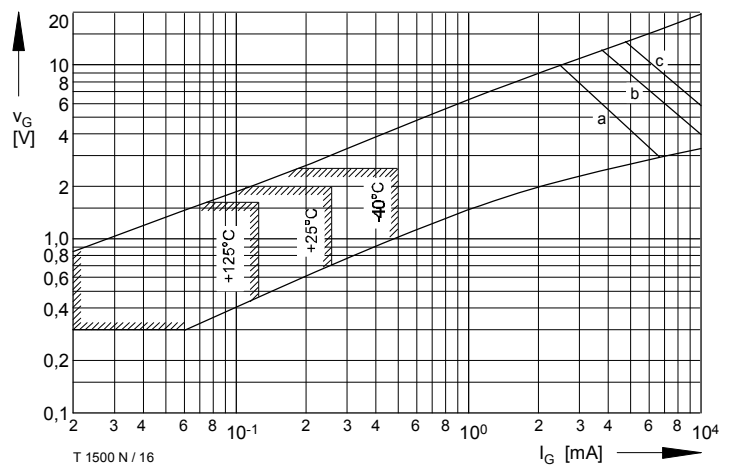

Bild / Fig. 18
 Grenzstrom / Max. overload on-state current $I_{T(OV)M} = f(t)$, $v_{RM} = 0,8 V_{RRM}$
 Beidseitige Kühlung / Two-sided cooling
 Kühlkörper / Heatsink: K0.05F
 Belastung aus / Surge current occurs:
 a - Leerlauf / No-load conditions
 b - Betrieb mit Dauergrenzstrom / During operation at max. average on-state current I_{TAVM}

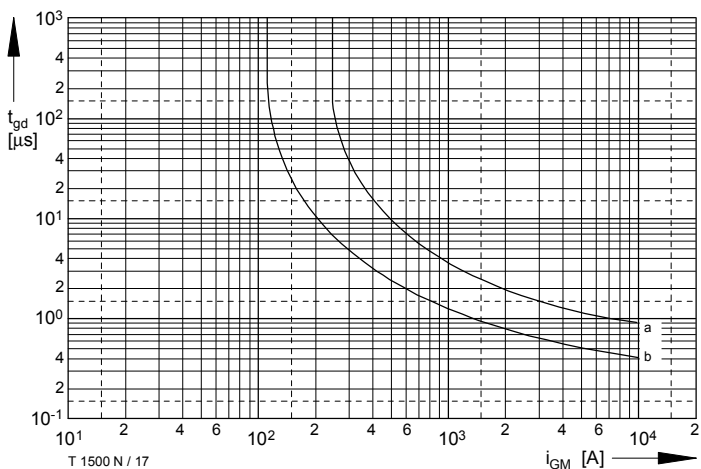

Bild / Fig. 19
Sperrverzögerungsladung / Recovered charge $Q_r = f(di/dt)$
 $t_{vj} = t_{vj \max}$; $V_R = 0,5 V_{RRM}$; $V_{RM} = 0,8 V_{RRM}$
Parameter: Durchlaßstrom / On-state current i_{TM}

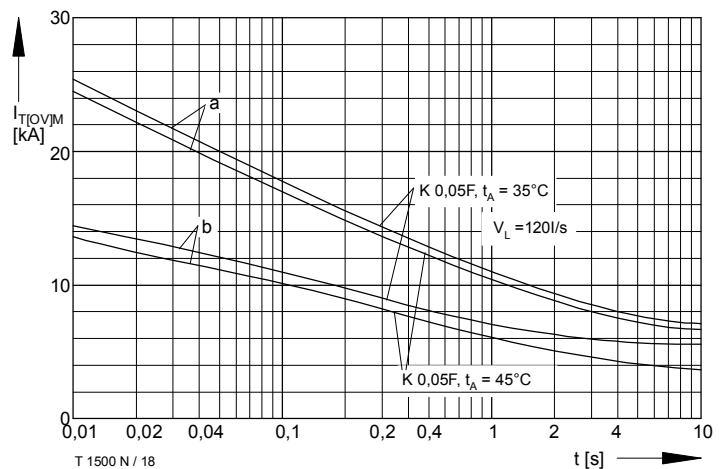

Bild / Fig. 20
Transienter innerer Wärmewiderstand / Transient thermal impedance
 $Z_{thJC} = f(t)$
Beidseitige Kühlung / Two-sided cooling
Parameter: Stromflußwinkel / current conduction angle θ

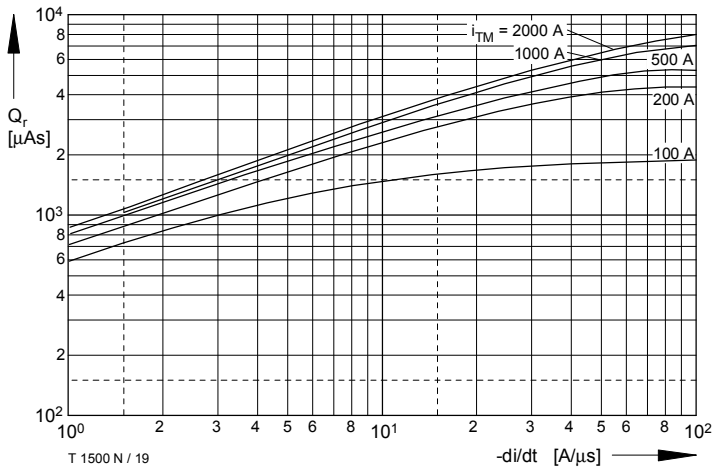

Bild / Fig. 21
Transienter innerer Wärmewiderstand / Transient thermal impedance
 $Z_{thJC} = f(t)$
Anodenseitige Kühlung / Anode-sided cooling
Parameter: Stromflußwinkel / current conduction angle θ

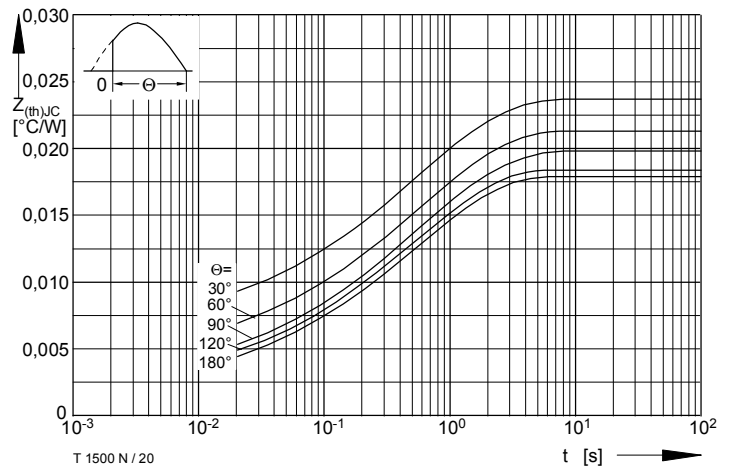

Bild / Fig. 22
Transienter innerer Wärmewiderstand / Transient thermal impedance
 $Z_{thJC} = f(t)$
Beidseitige Kühlung / Two-sided cooling
Parameter: Stromflußwinkel / current conduction angle θ

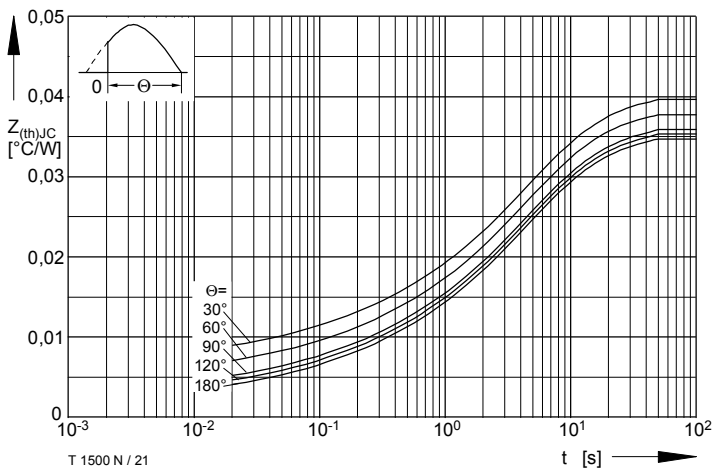

Bild / Fig. 23
Transienter innerer Wärmewiderstand / Transient thermal impedance
 $Z_{thJC} = f(t)$
Anodenseitige Kühlung / Anode-sided cooling
Parameter: Stromflußwinkel / current conduction angle θ

Analytische Elemente des transienten Wärmewiderstandes Z_{thJC} pro Zweig für DC
Analytical elements of transient thermal impedance Z_{thJC} per arm for DC

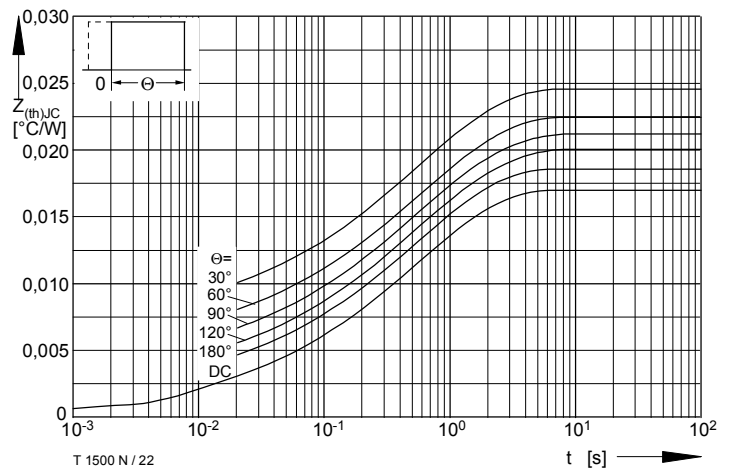
Beidseitig / Two-sided

Pos. n	1	2	3	4	5	6
R_{thn} [$^{\circ}\text{C}/\text{W}$]	0,00022	0,0011	0,00102	0,00283	0,00608	0,00575
τ_n [s]	0,00136	0,00306	0,0139	0,0662	0,512	1,49

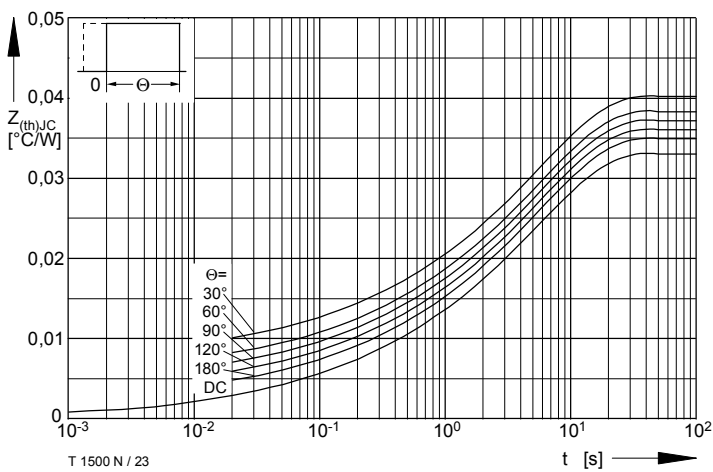
Anodenseitig / Anode-sided

Pos. n	1	2	3	4	5	6
R_{thn} [$^{\circ}\text{C}/\text{W}$]	0,00065	0,0019	0,00239	0,00381	0,00425	0,02
τ_n [s]	0,0016	0,0091	0,0791	0,26	1,736	7,21

Kathodenseitig / Cathode-sided

Pos. n	1	2	3	4	5	6
R_{thn} [$^{\circ}\text{C}/\text{W}$]	0,00055	0,00206	0,00604	0,00551	0,02084	
τ_n [s]	0,0014	0,00857	0,154	2,58	7,007	

Analytische Funktion / Analytical function:

$$Z_{thJC} = \sum_{n=1}^{n_{\max}} R_{thn} (1 - e^{-t/\tau_n})$$