

vorläufige Daten  
 preliminary data

### Höchstzulässige Werte / maximum rated values

#### Elektrische Eigenschaften / electrical properties

Kollektor Emitter Sperrspannung collector emitter voltage	$T_{vj}=25^{\circ}\text{C}$	$V_{CES}$	1200	V
Kollektor Dauergleichstrom DC collector current	$T_c=80^{\circ}\text{C}$ $T_c=25^{\circ}\text{C}$	$I_{C,nom}$ $I_C$	150 200	A A
Periodischer Kollektor Spitzenstrom repetitive peak collector current	$t_p=1\text{ms}, T_c=80^{\circ}\text{C}$	$I_{CRM}$	300	A
Gesamt Verlustleistung total power dissipation	$T_c=25^{\circ}\text{C};$ Transistor	$P_{tot}$	700	W
Gate Emitter Spitzenspannung gate emitter peak voltage		$V_{GES}$	+/- 20	V
Dauergleichstrom DC forward current		$I_F$	150	A
Periodischer Spitzenstrom repetitive peak forward current	$t_p=1\text{ms}$	$I_{FRM}$	300	A
Grenzlastintegral $I^2t$ value	$V_R=0\text{V}, t_p=10\text{ms}, T_{vj}=125^{\circ}\text{C}$	$I^2t$	4,6	$\text{kA}^2\text{s}$
Isolations Prüfspannung insulation test voltage	RMS, $f=50\text{Hz}, t=1\text{min.}$	$V_{ISOL}$	2,5	kV

### Charakteristische Werte / characteristic values

#### Transistor Wechselrichter / transistor inverter

			min.	typ.	max.	
Kollektor Emitter Sättigungsspannung collector emitter saturation voltage	$I_C=150\text{A}, V_{GE}=15\text{V}, T_{vj}=25^{\circ}\text{C}$	$V_{CESat}$	-	1,7	2,15	V
	$I_C=150\text{A}, V_{GE}=15\text{V}, T_{vj}=125^{\circ}\text{C}$		-	2,0	t.b.d.	V
Gate Schwellenspannung gate threshold voltage	$I_C=6\text{mA}, V_{CE}=V_{GE}, T_{vj}=25^{\circ}\text{C}$	$V_{GE(th)}$	5,0	5,8	6,5	V
Gateladung gate charge	$V_{GE}=-15\text{V}\dots+15\text{V}$	$Q_G$	-	1,4	-	$\mu\text{C}$
Eingangskapazität input capacitance	$f=1\text{MHz}, T_{vj}=25^{\circ}\text{C}, V_{CE}=25\text{V}, V_{GE}=0\text{V}$	$C_{ies}$	-	10,6	-	nF
Rückwirkungskapazität reverse transfer capacitance	$f=1\text{MHz}, T_{vj}=25^{\circ}\text{C}, V_{CE}=25\text{V}, V_{GE}=0\text{V}$	$C_{res}$	-	0,5	-	nF
Kollektor Emitter Reststrom collector emitter cutt off current	$V_{GE}=0\text{V}, T_{vj}=25^{\circ}\text{C}, V_{CE}=600\text{V}$	$I_{CES}$	-	-	5	mA
Gate Emitter Reststrom gate emitter leakage current	$V_{CE}=0\text{V}, V_{GE}=20\text{V}, T_{vj}=25^{\circ}\text{C}$	$I_{GES}$	-	-	400	nA

prepared by: MOD-D2; Mark Münzer	date of publication: 2002-10-28
approved: SM TM; Wilhelm Rusche	revision: 2.0

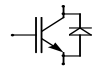

vorläufige Daten  
preliminary data

### Charakteristische Werte / characteristic values

#### Transistor Wechselrichter / transistor inverter

			min.	typ.	max.	
Einschaltverzögerungszeit (induktive Last) turn on delay time (inductive load)	$I_C = 150A, V_{CC} = 600V$	$t_{d,on}$	-	0,25	-	$\mu s$
	$V_{GE} = \pm 15V, R_G = 8,2\Omega, T_{vj} = 25^\circ C$			0,30		
Anstiegszeit (induktive Last) rise time (inductive load)	$I_C = 150A, V_{CC} = 600V$	$t_r$	-	0,09	-	$\mu s$
	$V_{GE} = \pm 15V, R_G = 8,2\Omega, T_{vj} = 25^\circ C$			0,10		
Abschaltverzögerungszeit (induktive Last) turn off delay time (inductive load)	$I_C = 150A, V_{CC} = 600V$	$t_{d,off}$	-	0,55	-	$\mu s$
	$V_{GE} = \pm 15V, R_G = 8,2\Omega, T_{vj} = 25^\circ C$			0,65		
Fallzeit (induktive Last) fall time (inductive load)	$I_C = 150A, V_{CC} = 600V$	$t_f$	-	0,13	-	$\mu s$
	$V_{GE} = \pm 15V, R_G = 8,2\Omega, T_{vj} = 25^\circ C$			0,18		
Einschaltverlustenergie pro Puls turn on energy loss per pulse	$I_C = 150A, V_{CC} = 600V, L_\sigma = 80nH$ $V_{GE} = \pm 15V, R_G = 8,2\Omega, T_{vj} = 25^\circ C$	$E_{on}$	-	11	-	mJ
Ausschaltverlustenergie pro Puls turn off energy loss per pulse	$I_C = 150A, V_{CC} = 600V, L_\sigma = 80nH$ $V_{GE} = \pm 15V, R_G = 8,2\Omega, T_{vj} = 25^\circ C$	$E_{off}$	-	24	-	mJ
Kurzschlussverhalten SC data	$t_p \leq 10\mu s, V_{GE} \leq 15V, T_{vj} \leq 125^\circ C$ $V_{CC} = 900V, V_{CEmax} = V_{CES} - L_{\sigma CE} \cdot di/dt$	$I_{SC}$	-	600	-	A
Modulinduktivität stray inductance module		$L_{\sigma CE}$	-	20	-	nH
Leitungswiderstand, Anschluss-Chip lead resistance, terminal-chip	$T_C = 25^\circ C$	$R_{CC/EE}$	-	1,1	-	m $\Omega$

### Charakteristische Werte / characteristic values

#### Diode Wechselrichter / diode inverter

Durchlassspannung forward voltage	$I_F = 150A, V_{GE} = 0V, T_{vj} = 25^\circ C$	$V_F$	-	1,65	2,15	V
	$I_F = 150A, V_{GE} = 0V, T_{vj} = 125^\circ C$			1,65	t.b.d.	V
Rückstromspitze peak reverse recovery current	$I_F = 150A, -di_F/dt = 1500A/\mu s$	$I_{RM}$	-	110	-	A
	$V_R = 600V, V_{GE} = -15V, T_{vj} = 25^\circ C$			140	-	A
Sperrverzögerungsladung recovered charge	$I_F = 150A, -di_F/dt = 1500A/\mu s$	$Q_r$	-	15	-	$\mu C$
	$V_R = 600V, V_{GE} = -15V, T_{vj} = 25^\circ C$			28	-	$\mu C$
Ausschaltenergie pro Puls reverse recovery energy	$I_F = 150A, -di_F/dt = 1500A/\mu s$	$E_{rec}$	-	7	-	mJ
	$V_R = 600V, V_{GE} = -15V, T_{vj} = 25^\circ C$			14	-	mJ

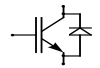

vorläufige Daten  
 preliminary data

### Charakteristische Werte / characteristic values

NTC-Widerstand / NTC-thermistor

			min.	typ.	max.	
Nennwiderstand rated resistance	$T_c = 25^\circ\text{C}$	$R_{25}$	-	5	-	k $\Omega$
Abweichung von $R_{100}$ deviation of $R_{100}$	$T_c = 100^\circ\text{C}, R_{100} = 493\Omega$	$\Delta R/R$	-5	-	5	%
Verlustleistung power dissipation	$T_c = 25^\circ\text{C}$	$P_{25}$	-	-	20	mW
B-Wert B-value	$R_2 = R_1 \exp[B(1/T_2 - 1/T_1)]$	$B_{25/50}$	-	3375	-	K

### Thermische Eigenschaften / thermal properties

Innerer Wärmewiderstand; DC thermal resistance, junction to case; DC	Transistor Wecheln. / transistor inverter	$R_{thJC}$	-	-	0,180	K/W
	Diode Wechselrichter / diode inverter		-	-	0,340	K/W
Übergangs Wärmewiderstand thermal resistance, case to heatsink	pro Modul / per module $\lambda_{paste} = 1\text{W/m}^2\text{K} / \lambda_{grease} = 1\text{W/m}^2\text{K}$	$R_{thCK}$	-	0,005	-	K/W
Höchstzulässige Sperrschichttemp. maximum junction temperature		$T_{vj\ max}$	-	-	150	$^\circ\text{C}$
Betriebstemperatur operation temperature		$T_{vj\ op}$	-40	-	125	$^\circ\text{C}$
Lagertemperatur storage temperature		$T_{stg}$	-40	-	125	$^\circ\text{C}$

### Mechanische Eigenschaften / mechanical properties

Gehäuse, siehe Anlage case, see appendix						
Innere Isolation internal insulation				$\text{Al}_2\text{O}_3$		
Kriechstrecke creepage distance				12,7		mm
Luftstrecke clearance distance				10,0		mm
CTI comperative tracking index				225		
Anzugsdrehmoment, mech. Befestigung mounting torque	Schraube / screw M5	M	3	-	6	Nm
Anzugsdrehmoment, elektr. Anschlüsse terminal connection torque	Anschlüsse / terminals M6	M	3	-	6	Nm
Gewicht weight		G		910		g

Mit dieser technischen Information werden Halbleiterbauelemente spezifiziert, jedoch keine Eigenschaften zugesichert. Sie gilt in Verbindung mit den zugehörigen technischen Erläuterungen.

This technical information specifies semiconductor devices but promises no characteristics. It is valid with the belonging technical notes.



vorläufige Daten  
preliminary data

**Ausgangskennlinie (typisch)**  
**output characteristic (typical)**

$I_C = f(V_{CE})$   
 $V_{GE} = 15V$

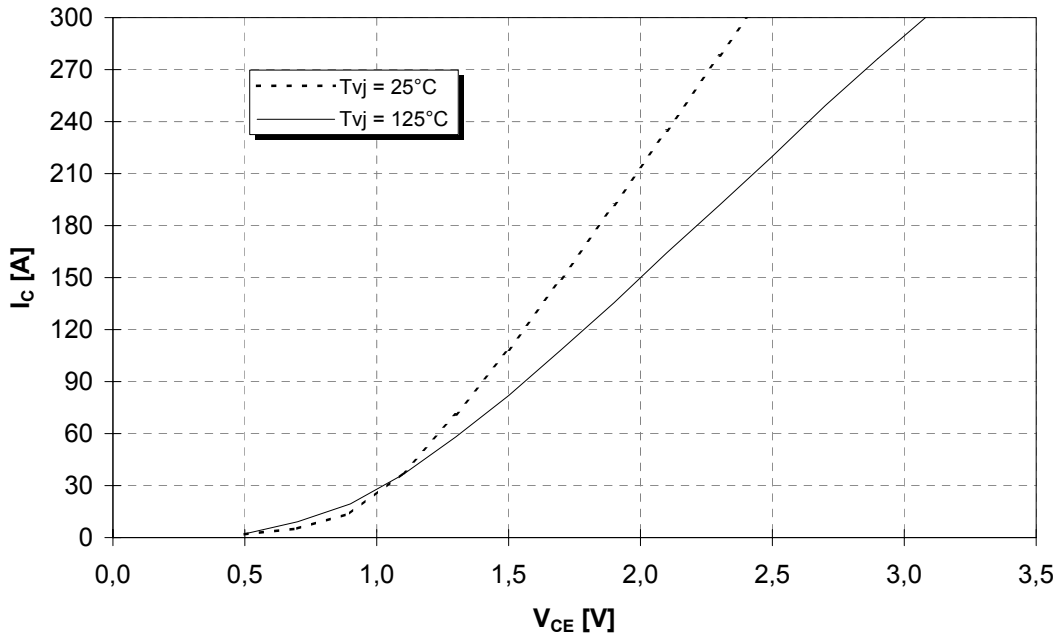

**Ausgangskennlinienfeld (typisch)**  
**output characteristic (typical)**

$I_C = f(V_{CE})$   
 $T_{vj} = 125^\circ C$

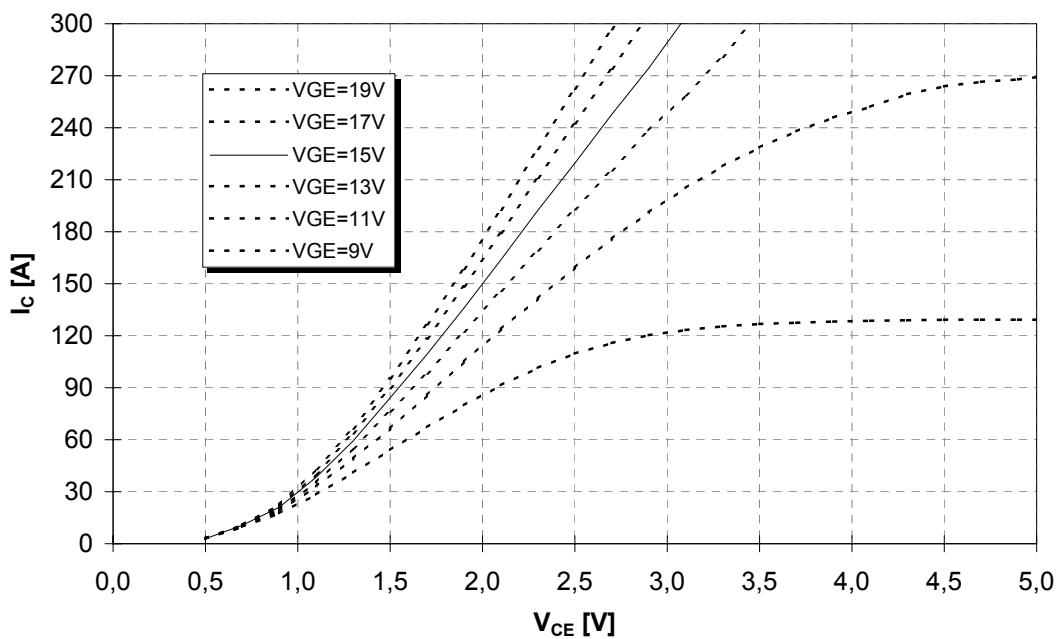



vorläufige Daten  
preliminary data

Übertragungscharakteristik (typisch)  
transfer characteristic (typical)

$I_C = f(V_{GE})$   
 $V_{CE} = 20V$

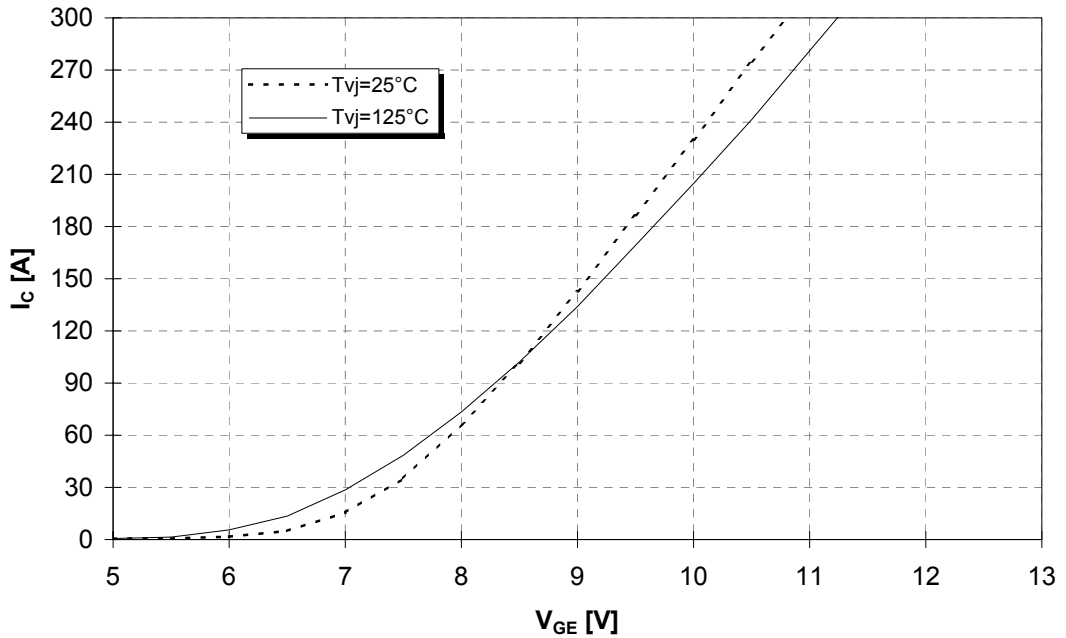

Durchlasskennlinie der Inversdiode (typisch)  
forward characteristic of inverse diode (typical)

$I_F = f(V_F)$

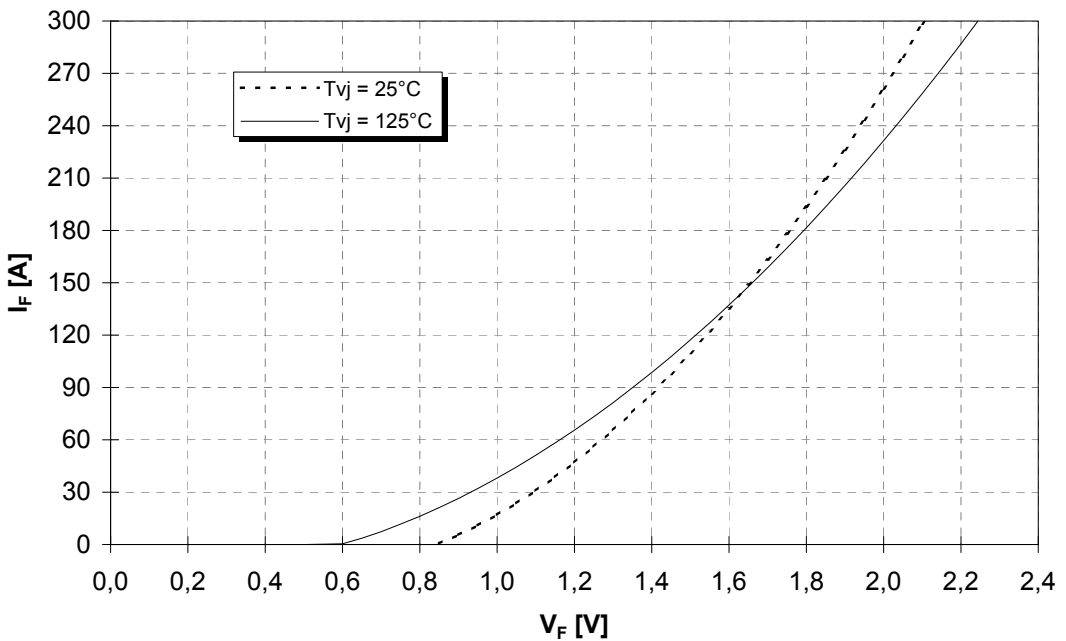



vorläufige Daten  
preliminary data

Schaltverluste (typisch)  
Switching losses (typical)

$E_{on} = f(I_C)$  ,  $E_{off} = f(I_C)$  ,  $E_{rec} = f(I_C)$   
 $V_{GE}=\pm 15V$ ,  $R_G=8,2\Omega$ ,  $V_{CE}=600V$ ,  $T_{vj}=125^\circ C$

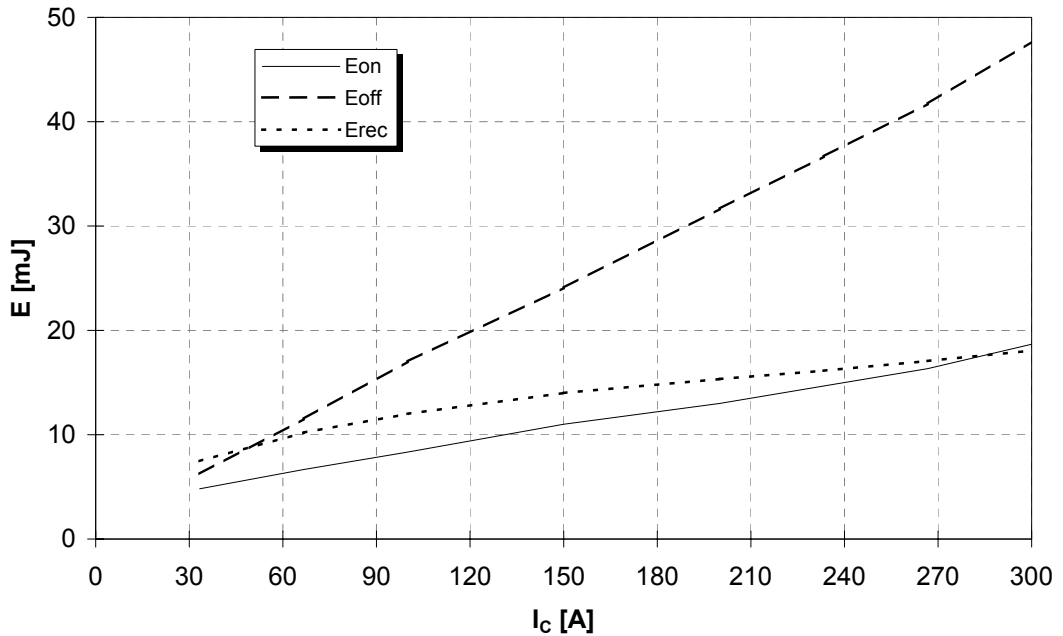

Schaltverluste (typisch)  
Switching losses (typical)

$E_{on} = f(R_G)$  ,  $E_{off} = f(R_G)$  ,  $E_{rec} = f(R_G)$   
 $V_{GE}=\pm 15V$ ,  $I_C=150A$ ,  $V_{CE}=600V$ ,  $T_{vj}=125^\circ C$

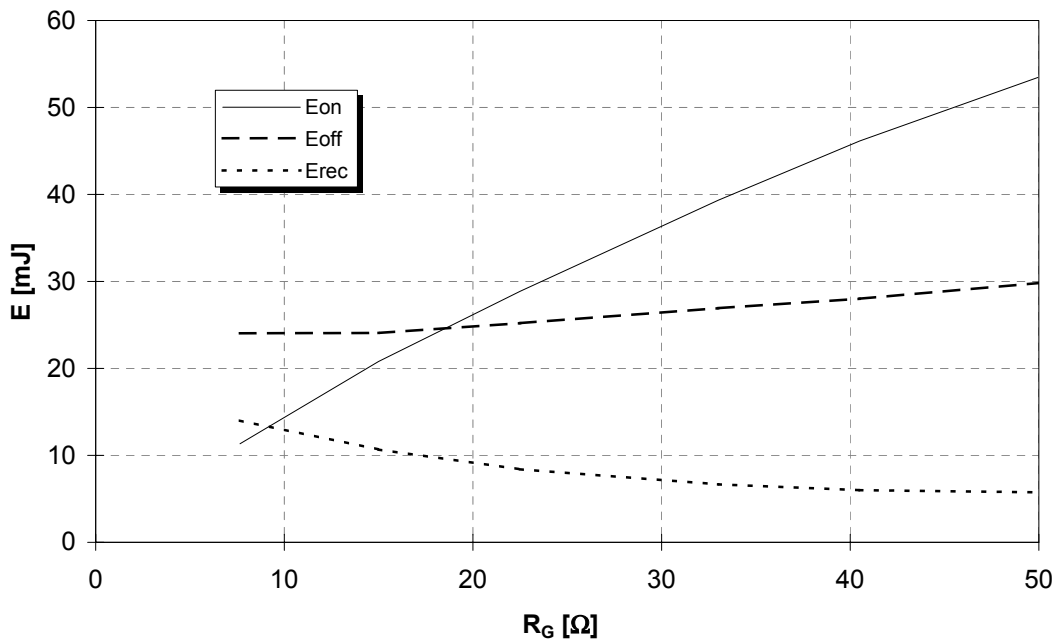



vorläufige Daten  
preliminary data

Transienter Wärmewiderstand  
Transient thermal impedance

$$Z_{thJC} = f(t)$$

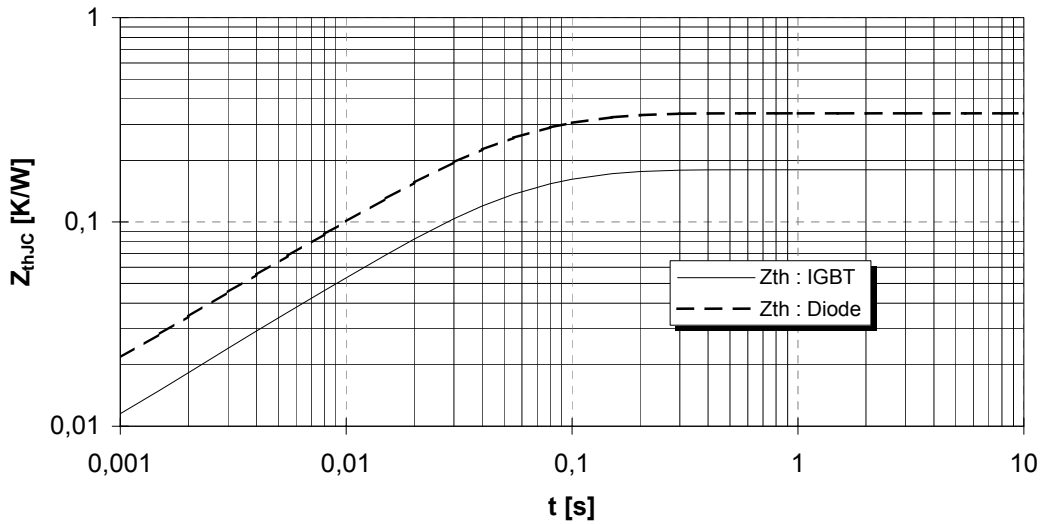

i	1	2	3	4
$r_i$ [K/kW] : IGBT	75,66	90,68	10,25	3,41
$\tau_i$ [s] : IGBT	6,499E-02	2,601E-02	2,364E-03	1,187E-05
$r_i$ [K/kW] : Diode	142,85	171,43	19,31	6,41
$\tau_i$ [s] : Diode	6,499E-02	2,601E-02	2,364E-03	1,187E-05

Sicherer Arbeitsbereich (RBSOA)

Reverse bias safe operation area (RBSOA)

$$V_{GE} = \pm 15V, R_G = 8,2 \Omega, T_{Vj} = 125^\circ C$$

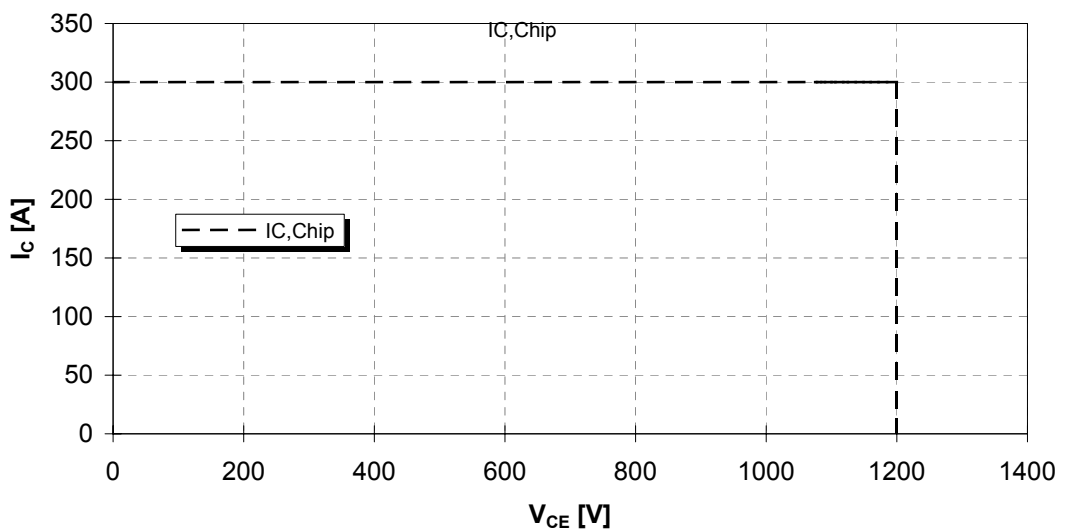

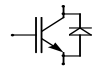

vorläufige Daten  
preliminary data

Gehäusemaße / Schaltbild  
Package outline / Circuit diagram

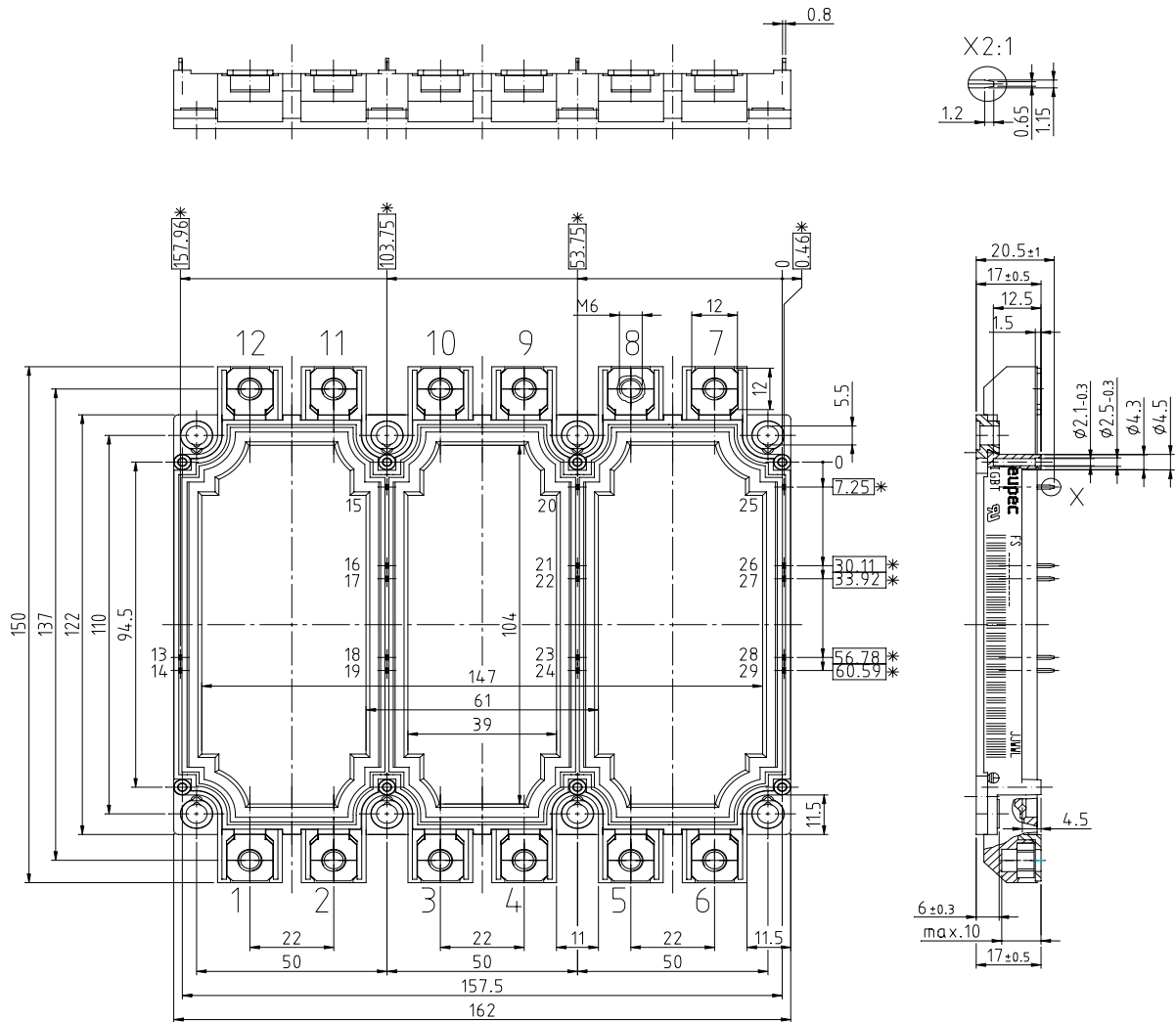

\* = alle Maße mit einer Toleranz von  $\pm 0.5$

