

Your Industry. Our Indicators.



Indicator



Multiple input and process measurement indication
3-points of alarm output as standard

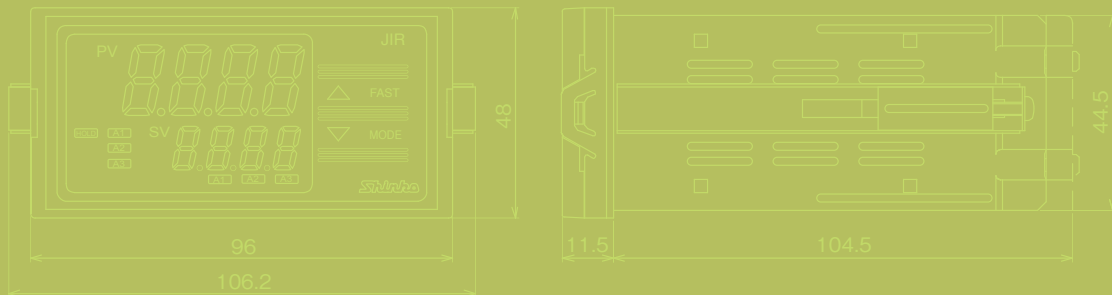

Standard transmission output (4 to 20mA DC)

Dust-proof/Drip-proof (IP66)



Features

Multi-input

Total 18 types of input can be chosen from thermocouple (10 types), RTD (2 types), DC current (2 types) and DC voltage (4 types).

Alarm output (3 points) is provided as standard.

Alarm output (3 points) is available as standard.
Alarm action type and status Energized/De-energized can be easily switched by key operation. (Default: No alarm action, Energized)

Standard transmission output.

Converting the input value to analog signal every 0.25 seconds, and outputs the value in DC current.
4 to 20mA DC is standard output.

Modbus

Serial communication (C5 option) protocol comprises Shinko protocol and Modbus protocol. For Modbus protocol, RTU mode and ASCII mode are selectable by key operation. Without the communication converter, Modbus compatible instruments can be connected.

Standard Dust-proof/Drip-proof function (for front part only)

IP66 structure means the indicator can be used even in harsh environment exposed to dust and water splashes.

Safety standards

UL/C-UL, CE marking

Specifications

Model names

JIR-301-M □ / □ □ □		Series name: JIR-301-M	
Input	M	Multi-input	
Power supply	1	24V AC/DC	
Option	TA	DC current output	0 to 20mA DC
	TV	Specified transmission output	0 to 1V DC
		DC voltage output	0 to 5V DC
			1 to 5V DC
	C5	Serial communication (Based on EIA RS-485)	
	P24	Insulated power output	
BK	Color, black		
TC	Terminal cover		

Please designate the specification from the □, □ □ □ columns.
When adding an option, enter it punctuated by a comma.

- When P24 option is added, Alarm 2 output is not available.
- When C5 option is added, Hold function is not available.
- For the supply voltage, 100 to 240V AC is standard. However, when ordering 24V AC/DC, enter "1" after the input.

Rated range

Input type		Input range	
Thermocouple	K	-200 to 1370 °C	-320 to 2500 °F
	J	-199.9 to 400.0 °C	-199.9 to 750.0 °F
	R	-200 to 1000 °C	-320 to 1800 °F
	S	0 to 1760 °C	0 to 3200 °F
	B	0 to 1760 °C	0 to 3200 °F
	E	0 to 1820 °C	0 to 3300 °F
	T	-200 to 850 °C	-320 to 1500 °F
	T	-199.9 to 400.0 °C	-199.9 to 750.0 °F
	N	-200 to 1300 °C	-320 to 2300 °F
	PL - II	0 to 1390 °C	0 to 2500 °F
	C (W/Re5-26)	0 to 2315 °C	0 to 4200 °F
RTD	Pt100	-200 to 850 °C	-300 to 1500 °F
	JPt100	-199.9 to 850.0 °C	-199.9 to 999.9 °F
DC current	4 to 20mA DC	-200 to 500 °C	-300 to 900 °F
	0 to 20mA DC		
DC voltage	0 to 1V DC	-1999 to 9999, -199.9 to 999.9	
	0 to 10V DC		
	1 to 5V DC		
	0 to 5V DC		

- For DC current and voltage input, scaling is possible and decimal point place can be changed.
- For DC current input, 50Ω shunt resistor (sold separately, model: RES-S02-050) must be externally installed.

Name and functions of the sections

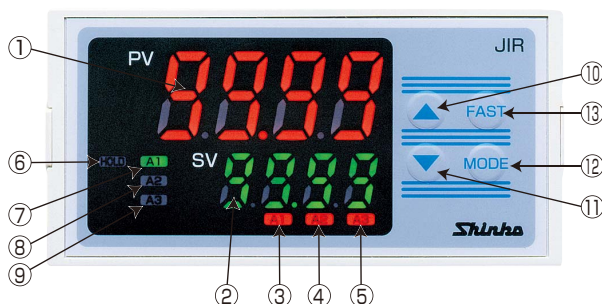

- ① PV display : Indicates PV (process variable) or characters in the setting mode with the red LED.
- ② SV display : Indicates the alarm value or set value in the setting mode with the green LED.
- ③ A1 action indicator : When A1 output is ON, the red LED lights.
- ④ A2 action indicator : When A2 output is ON, the red LED lights.
- ⑤ A3 action indicator : When A3 output is ON, the red LED lights.
- ⑥ HOLD indicator : When PV HOLD (Hold, Peak hold, Bottom hold) output is ON, the yellow LED lights.
- ⑦ A1 value indicator : When A1 value is indicated, the green LED lights.
- ⑧ A2 value indicator : When A2 value is indicated, the green LED lights.
- ⑨ A3 value indicator : When A3 value is indicated, the green LED lights.
- ⑩ Increase key : Increases the numeric value.
- ⑪ Decrease key : Decreases the numeric value.
- ⑫ Mode key : Selects the setting mode or registers the set value. (To register the set value or selected value, press the MODE key)
- ⑬ Fast key : Makes the set value change faster while holding down the Increase or Decrease key together.

Standard specifications

Display	PV: Red LED 4-digit, character size, 16 x 7.2mm (H x W) SV: Green LED 4-digit, character size, 10 x 4.8mm (H x W)
Input	Thermocouple : K, J, R, S, B, E, T, N, PL-II, C (W/Re5-26) External resistance: 100Ω or less (for B input, 40Ω or less) RTD : Pt100, JPt100 3-wire system (Allowable input lead wire resistance: 10Ω or less per wire) DC current : 0 to 20mA DC, 4 to 20mA DC Input impedance: 50Ω (Install 50Ω shunt resistor between input terminals) Allowable input current: 50mA or less (when 50Ω shunt resistor is used) DC voltage : 0 to 1V DC Input impedance: 1MΩ or more Allowable input voltage: 5V or less Allowable signal source resistance: 2kΩ or less 0 to 5V DC, 1 to 5V DC, 0 to 10V DC Input impedance: 100kΩ or more Allowable input voltage: 15V or less Allowable signal source resistance: 100Ω or less
Accuracy (Setting/indication)	Thermocouple : Within ±0.2% of each input span ±1digit, or within ±2°C(4°F), whichever is greater However, R, S inputs, 0 to 200°C(0 to 400°F): Within ±6°C(12°F) B input, 0 to 300°C(0 to 600°F): Accuracy is not guaranteed. K, J, E, T, N inputs, less than 0°C(32°F): Within ±0.4% of each input span ±1digit RTD : Within ±0.1% of each input span ±1digit, or within ±1°C(2°F), whichever is greater DC current, voltage: Within ±0.2% of each input span ±1digit
Input sampling period	0.25 seconds
Alarm 1 (A1) Alarm 2 (A2) Alarm 3 (A3)	Alarm action and status Energized/De-energized can be selected by key operation. · No alarm action · High limit alarm Setting range: Input range low limit value to input range high limit value · Low limit alarm Setting range: Input range low limit value to input range high limit value · High limit alarm with standby Setting range: Input range low limit value to input range high limit value · Low limit alarm with standby Setting range: Input range low limit value to input range high limit value · High/Low limit range alarm(*1) Setting range: None When input has a decimal point, negative lower limit set value is -199.9, and positive upper limit set value is 999.9. Setting range for DC current and DC voltage inputs: Scaling low limit value to scaling high limit value. (*1) Only Alarm 3 (A3) can be selected. High/Low limit range alarm is activated depending on A1 and A2 set values. Setting accuracy : The same as indicating accuracy Action : ON/OFF action Hysteresis : Thermocouple, RTD: 0.1 to 100.0(°F) DC current, voltage: 1 to 1000 (The placement of the decimal point follows the selection) Output : Relay contact 1a, 3A 250V AC (resistive load), Electric life: 100,000 cycles
Transmission output	Converting the input value to analog signal every 0.25 seconds, and outputs the value in DC current. Resolution : 1/12000 DC current : 4 to 20mA DC (load resistance, Max. 550Ω) Output accuracy : Within ±0.3% of output span
Supply voltage	100 to 240V AC 50/60Hz, 24V AC/DC 50/60Hz Allowable voltage fluctuation range: 85 to 264V AC, 20 to 28V AC/DC
Power consumption	Approx. 8VA
Insulation resistance	10MΩ or more, at 500V DC
Dielectric strength	Between Input terminal and Ground terminal, Input terminal and Power terminal----- 1.5kV AC for 1 minute Between Power terminal and Ground terminal ----- 1.5kV AC for 1 minute Between Output terminal and Ground terminal, Output terminal and Power terminal---- 1.5kV AC for 1 minute (Output terminal comprises A1, A2 and A3 output terminals, transmission output terminals and communication terminals)
Environment	Ambient temperature: 0 to 50°C (32 to 122°F) Ambient humidity: 35 to 85%RH (Non-condensing)
Safety standard	UL: Power input rating 100-240V, 24V AC/DC File No. E159038
Material, color	Material: Flame resistant resin Color: Light grey
Mounting	Flush, Screw type mounting brackets (Panel thickness: 1 to 8mm)
Setting method	Sheet key input
External dimensions	W96 x H48 x D100mm
Weight	Approx. 300g
Attached functions	Sensor correction, Set value lock, Power failure countermeasure, Self-diagnosis, Automatic cold junction temperature compensation (only thermocouple), Sensor burnout alarm, Input burnout, Warm-up display, Dust-proof/Drip-proof IP66, Hold function

Options

[When ordering, designate an option code]

Specified transmission output [TA or TV]	Converting the input value to analog signal every 0.25 seconds, and outputs the value in DC current or voltage. If this option is applied, the standard transmission output (4 to 20mA) becomes ineffective. Resolution: 1/12000 DC current [TA] : 0 to 20mA DC (load resistance, max. 500Ω) DC voltage [TV] : 0 to 1V DC (load resistance, min. 100kΩ), 0 to 5V DC (load resistance, min. 500kΩ) 1 to 5V DC (load resistance, min. 500kΩ), 0 to 10V DC (load resistance, min. 1MΩ) Output accuracy : Within ±0.3% of output span
Serial communication [C5]	Operates various set value changes, set value readings and settings from external computer. If this option is added, Hold function is not available. Communication interface : Based on EIA RS-485 Communication method : Half-duplex communication Synchronization method : Start-stop synchronization Communication speed : 2400/4800/9600/19200bps Selectable by key operation Parity : Even/Odd/No parity Selectable by key operation Stop bit : 1, 2 Selectable by key operation Communication protocol : Shinko protocol/Modbus RTU/Modbus ASCII, Selectable by key operation Connectable number of unit : Max. 31 units per host computer Communication error detection : Dual-detection by parity and checksum
Insulated power output [P24]	24V DC is output from terminals 9 and 10, and this becomes the power source for a 2-wire transmitter. If this option is added, Alarm 2 (A2) output is not available. Output voltage: 24 ±3V DC (when load current is 30mA) Ripple voltage: 200mV (when load current is 30mA) Max. load current: 30mA
Color Black [BK]	The standard color of the base and case is light gray, however, if this option is added, the color will be black.
Terminal cover [TC]	Electric shock protection terminal cover (Be sure to use this terminal cover by adding this option if operator may touch the back of the controller while running the controller.)

Terminal arrangement

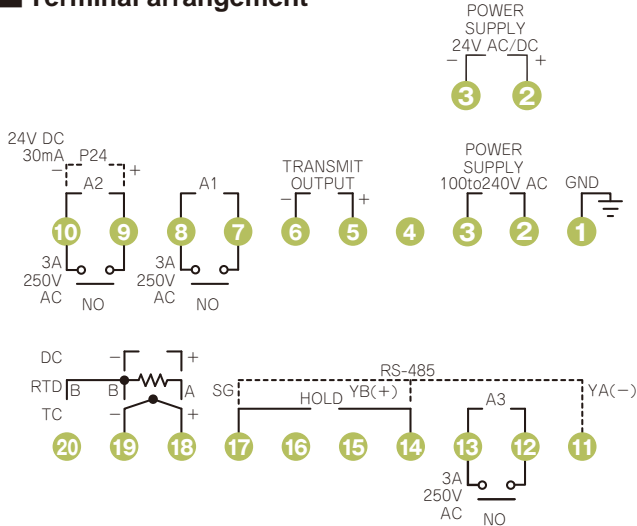

(Dotted lines shows optional terminals)

GND Ground terminal

TRANSMIT OUTPUT Transmission output terminals

A1, A2, A3 Alarm 1, Alarm 2 and Alarm 3 output terminals

P24 Insulated power output (24V DC) terminals

RS-485 Serial communication (C5) terminals (When the option is added)

HOLD Hold function input terminals

TC Thermocouple input terminals

RTD RTD input terminals

DC DC current or DC voltage input terminals



Caution

- Terminal block of this unit is designed to be wired from the upper side of the unit.
- When P24 option is added, Alarm 2 (A2) output is unavailable.
- When C5 option is added, Hold function is unavailable.

External dimensions (Scale: mm)

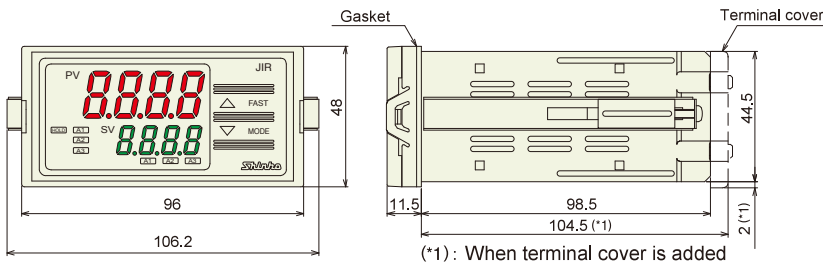

(*1): When terminal cover is added

Panel cutout (Scale: mm)

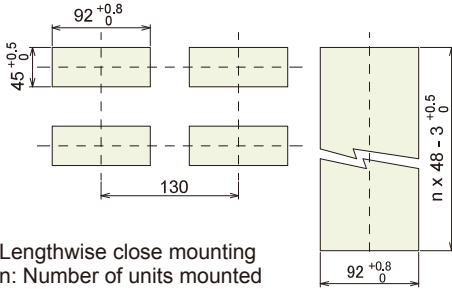

Lengthwise close mounting
n: Number of units mounted

Caution: For the lengthwise close mounting, Dust-proof/Drip-proof IP66 specification is not fulfilled.

Wiring example

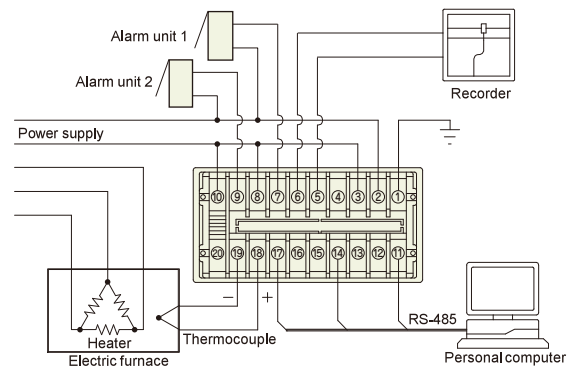

Solderless terminal

Use a solderless terminal with an insulation sleeve in which the M3 screw fits as shown below.

The torque should be 0.63N · m

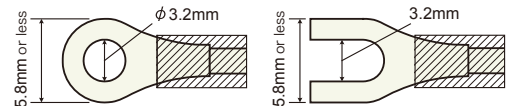

SAFETY PRECAUTIONS

- To ensure safe and correct use, thoroughly read and understand the manual before using this instrument.
- This instrument is intended to be used for industrial machinery, machine tools and measuring equipment. Verify correct usage after consulting purpose of use with our agency or main office. (Never use this instrument for medical purposes with which human lives are involved.)
- External protection devices such as protection equipment against excessive temperature rise, etc. must be installed, as malfunction of this product could result in serious damage to the system or injury to personnel. Also proper periodic maintenance is required.
- This instrument must be used under the conditions and environment described in the manual. Shinko Technos Co., Ltd. does not accept liability for any injury, loss of life or damage occurring due to the instrument being used under conditions not otherwise stated in this manual.

Caution with respect to Export Trade Control Ordinance

To avoid this instrument from being used as a component in, or as being utilized in the manufacture of weapons of mass destruction (i.e. military applications, military equipment, etc.), please investigate the end users and the final use of this instrument. In the case of resale, ensure that this instrument is not illegally exported.

This catalog is as of March 2009 and its contents are subject to change without notice. If you have any inquiries, please consult us or our agency.

SHINKO TECHNOS CO., LTD. OVERSEAS DIVISION

Reg. Office : 2-5-1, Senbahigashi, Minoo, Osaka, 562-0035, Japan
Tel : 81-72-727-6100
Fax : 81-72-727-7006
URL : <http://www.shinko-technos.co.jp>
E-mail : overseas@shinko-technos.co.jp