



Key Parameters

V_{DRM} / V_{RRM}	= 1600V
$I_{T(AV)}$	= 65A
I_{TSM}	= 1100A
$V_{T(TO)}$	= 0.95V
r_T	= 4.7mΩ

Features

- Full blocking capability over wide temperature range
- Hard soldered joints for high reliability

Applications

- Power Supplies
- DC motor control
- Controlled Rectifiers
- AC switch

Ordering Information

MS T	65	S	XX	U	B
Phase Control Thyristor	Current Code	Stud / Flat Base Version	Voltage Code Code X 100 = V_{DRM}/V_{RRM}	Stud Threads U = 1/4" UNF M = M8 x 1.25	Technology B = Solder Bond Technology
Order Code MS T65S16UB : 1600V V_{DRM}, V_{RRM} , Stud base Thyristor with 1/4" UNF threads					

Prepared by : ABA	Date of Publication : 25.03.2015
Approved by : RBS	Revision : 0

Symbol	Characteristic	Conditions	T _j [°C]	Value	Unit
BLOCKING					
V _{RRM}	Repetitive peak reverse voltage		125	200 - 1600	V
V _{RSM}	Non-repetitive peak reverse voltage		125	300 - 1700	V
V _{DRM}	Repetitive peak off-state voltage		125	200 - 1600	V
I _{RRM}	Repetitive peak reverse current	V = V _{RRM}	125	10	mA
I _{DRM}	Repetitive peak off-state current	V = V _{DRM}	125	10	mA
CONDUCTING					
I _{T(AV)}	Mean on state current	180° sin ,50 Hz, T _c =75°C		65	A
I _{RMS}	RMS on-state current			102	A
I _{TSM}	Surge on-state current	Sine wave, 10 ms Without reverse voltage	25	1100	A
			125	1000	A
I ² t	I ² t	Sine wave, 10 ms Without reverse voltage	25	6050	A ² s
			125	5000	A ² s
V _T	On-state voltage	On-state current = 200A	125	1.95	V
V _{T(TO)}	Threshold voltage		125	0.95	V
r _T	On-state slope resistance		125	4.7	mΩ
SWITCHING					
di/dt	Critical rate of rise of on-state current		125	150	A/μs
dv/dt	Critical rate of rise of off-state voltage	V _{DR} = 67%V _{DRM}	125	1000	V/μs
GATE					
I _{gt}	Gate trigger current	V _D =6V	25	150	mA
V _{gt}	Gate trigger voltage	V _D =6V	25	3.0	V
I _H	Holding current	V _D =6V, gate open circuit	25	200	mA
I _L	Latching current	V _D =6V	25	400	mA
MOUNTING					
R _{th(j-c)}	Thermal impedance, sin 180°	Junction to case		0.45	°C/W
R _{th(j-c)}	Thermal impedance, rec120°	Junction to case		0.52	°C/W
R _{th(c-h)}	Thermal impedance	Case to heatsink		0.20	°C/W
T _j	Max. junction temperature			125	°C
T _{stg}	Storage temperature			-40 125	°C
M	Mounting torque			4	NM
W	Weight (Approx.)			25	gm
			Prepared by : ABA	Date of Publication : 25.03.2015	
			Approved by : RBS	Revision : 0	

DISSIPATION CHARACTERISTICS

SINE WAVE

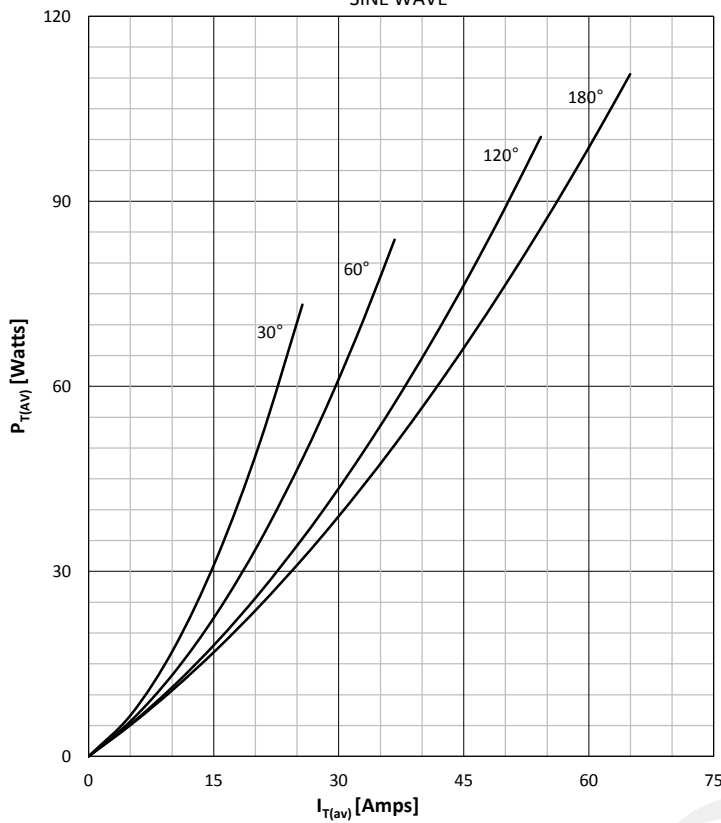

ON STATE CURRENT DERATING CURVE

SINE WAVE

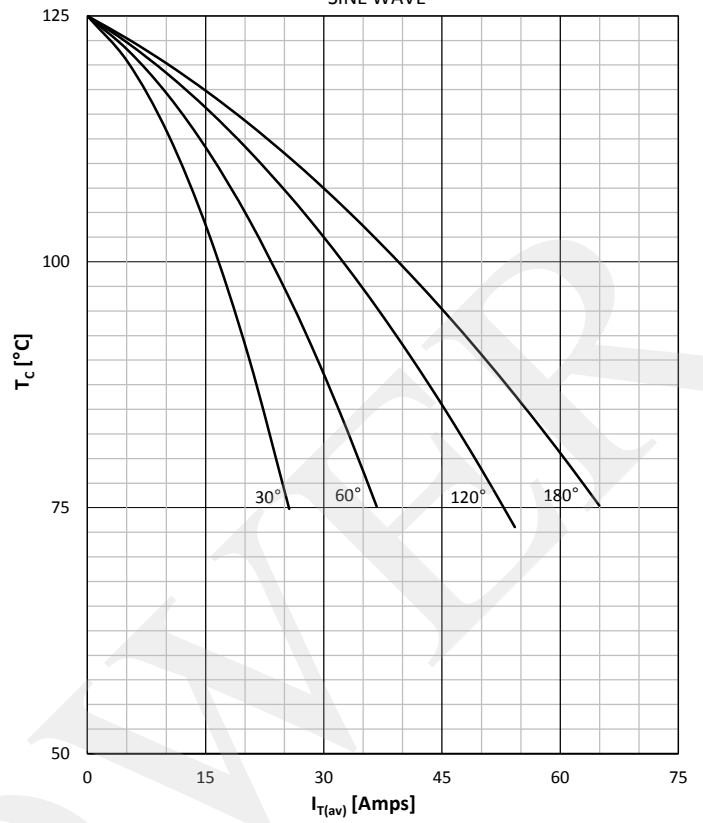

DISSIPATION CHARACTERISTICS

SQUARE WAVE

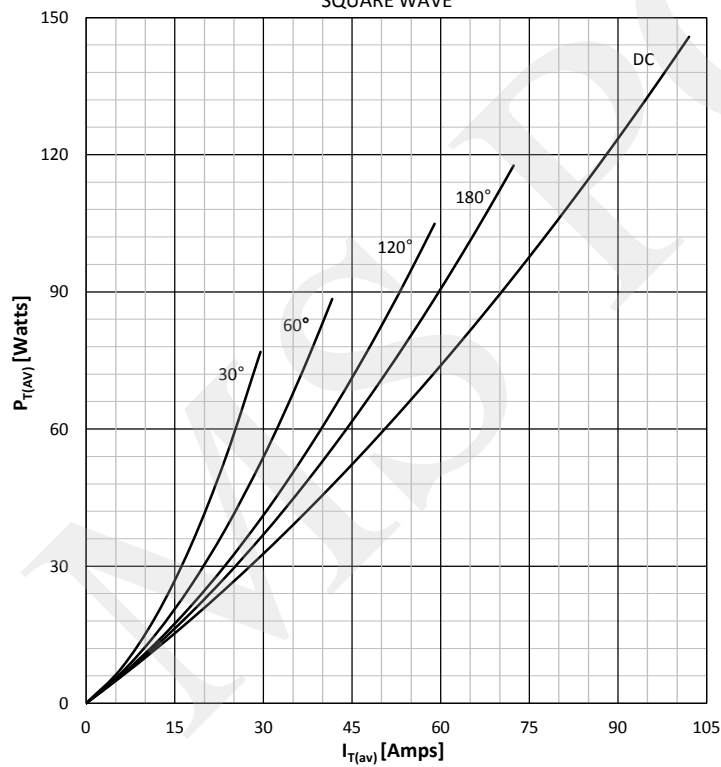

ON STATE CURRENT DERATING CURVE

SQUARE WAVE

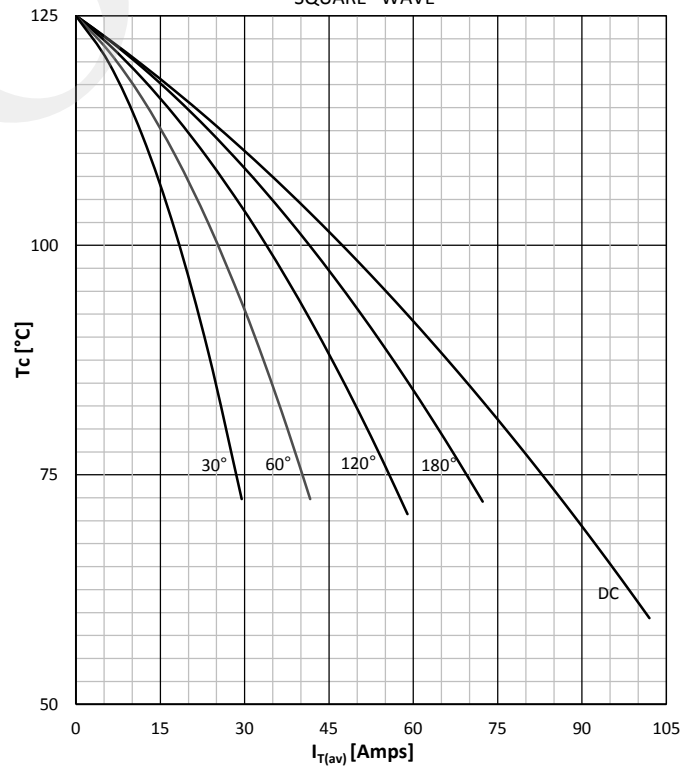

Prepared by : ABA

Date of Publication : 25.03.2015

Approved by : RBS

Revision : 0

ON STATE CHARACTERISTIC

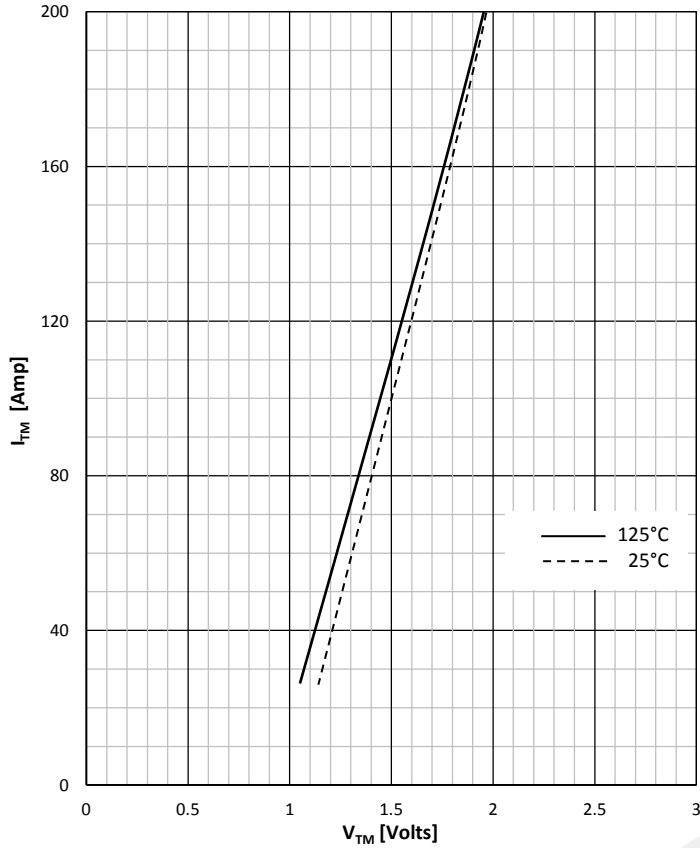

SURGE CHARACTERISTICS

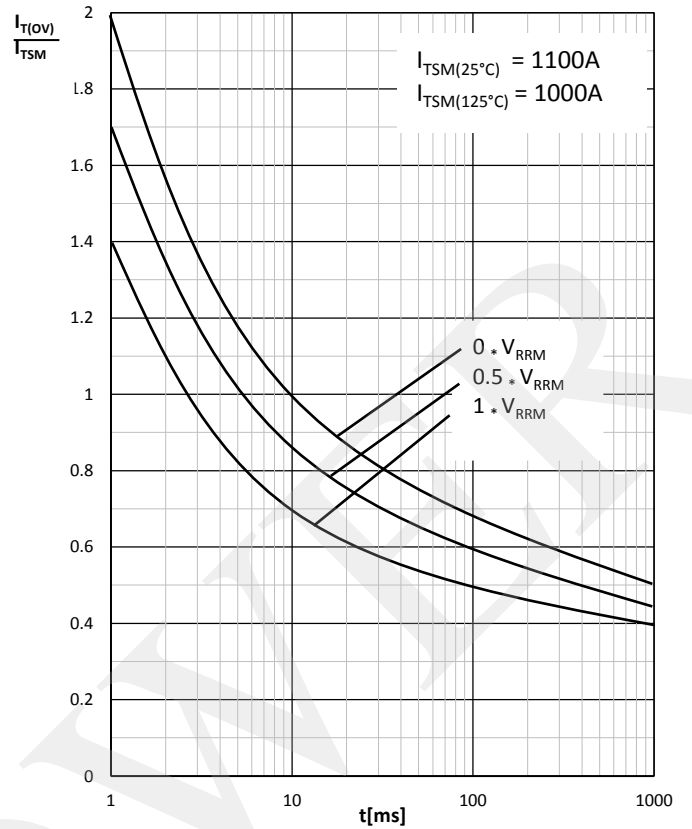

TRANSIENT THERMAL IMPEDANCE

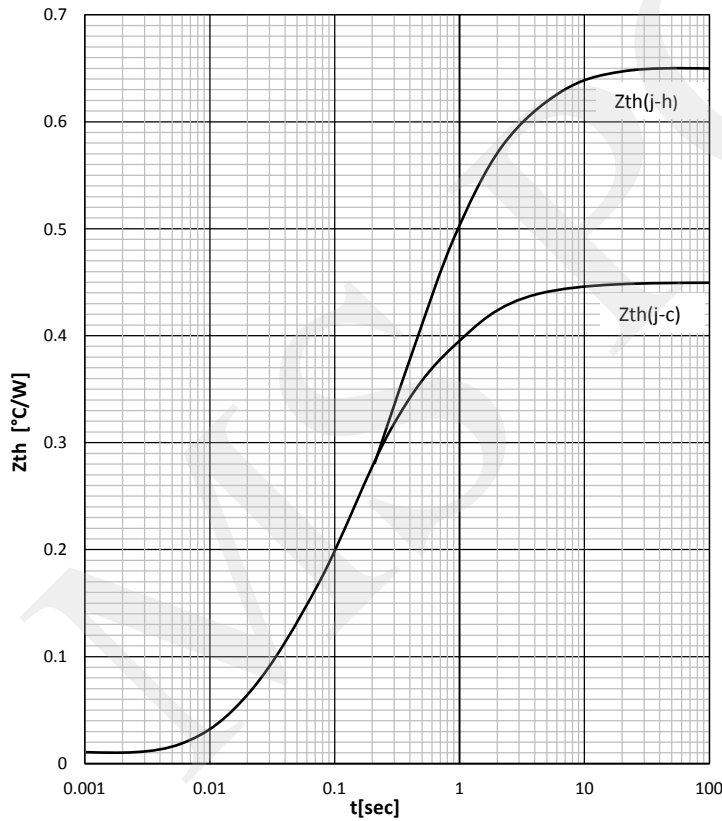

GATE TRIGGER CHARACTERISTICS

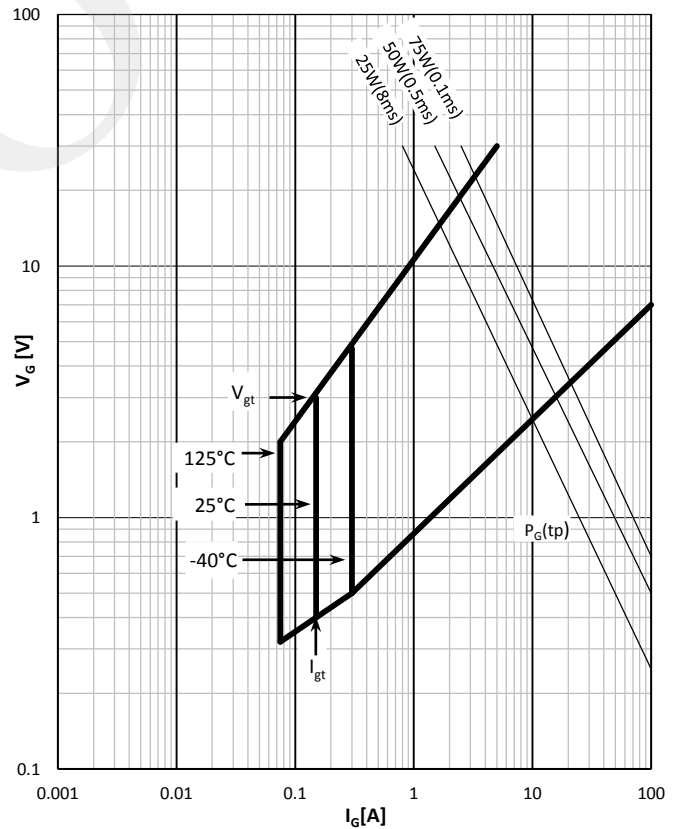

Prepared by : ABA

Date of Publication : 25.03.2015

Approved by : RBS

Revision : 0

Outline

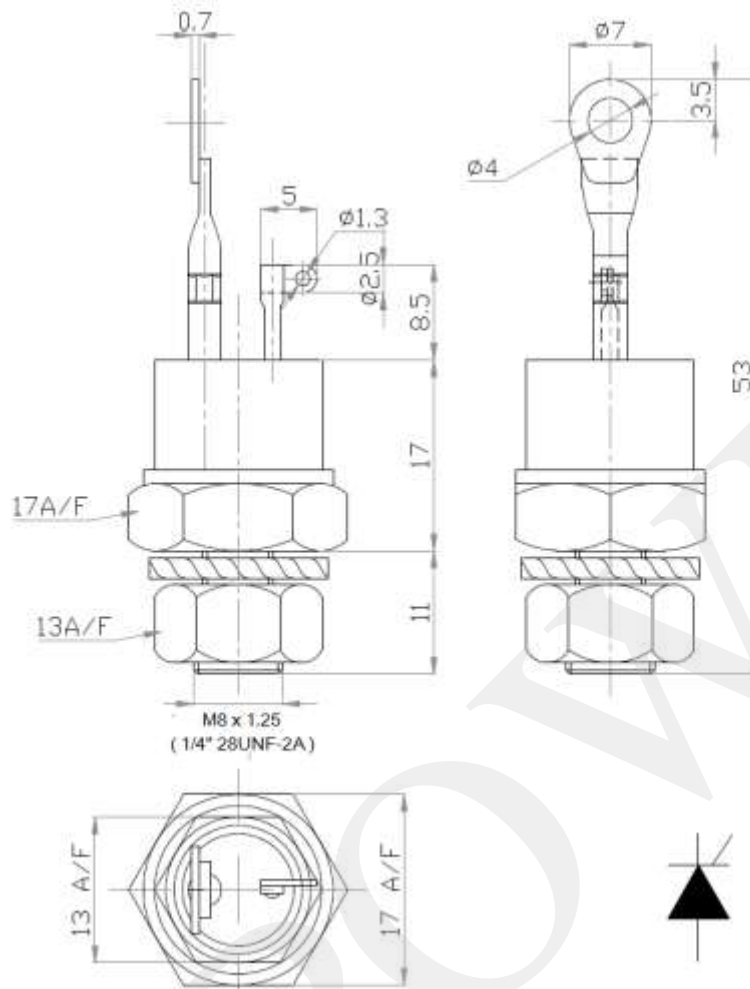

MS Power GmbH
Mergenthalerallee 23A
65760 Eschborn, Deutschland

www.mspowergroup.com

E-mail : info@mspowergroup.de

Prepared by : ABA

Date of Publication : 25.03.2015

Approved by : RBS

Revision : 0

Terms & Conditions of usage :

The data contained in this product datasheet is exclusively Intended for technically trained staff. You and your technical departments will have to evaluate the suitability of the product for the intended application and the completeness of the product data with respect to such application. This product datasheet is describing the characteristics of this product for which a warranty is granted. Any such warranty is granted exclusively pursuant the terms and conditions of the supply agreement. There will be no guarantee of any kind for the product and its characteristics. The information in the valid application-and assembly notes of the device must be considered.

Should you require product information in excess of the data given in this product datasheet or which concerns the specific application of our product, please contact the sales office, which is responsible for you (see www.mspowergroup.com). For those that are specifically interested we may provide application notes.

Due to technical requirements our product may contain dangerous substances. For information on the types in question please contact the sales office, which is responsible for you.

Should you intend to use the Product in aviation applications, in health or live endangering or life support applications, please notify. Please note, that for any such applications we urgently recommend

- to perform joint Risk and Quality Assessments;
- the conclusion of Quality Agreements;
- to establish joint measures of an ongoing product survey, and that we may make delivery depended on the realization of any such measures.

If and to the extent necessary, please forward equivalent notices to your customers.

Changes of this product datasheet are reserved.

Prepared by : ABA	Date of Publication : 25.03.2015
Approved by : RBS	Revision : 0